

Specification 規格

Model 型號	Rated Voltage 電壓 (V)	Rated Frequency 頻率 (Hz)	Gross Rated Power 功率 (W)	Rated Current 電流 (A)	Power (Hi / Lo) 功率 (高 / 低) (W)		Current (Hi / Lo) 電流 (高 / 低) (A)		Net Weight 重量 (kg)
					Heater (ON) 發熱器 (開)	Heater (OFF) 發熱器 (關)	Heater (ON) 發熱器 (開)	Heater (OFF) 發熱器 (關)	
FJ-T10T1	220	50	1,250	6	1,250 / 940	800 / 471	6 / 5	3.5 / 3	8

Dimension 尺寸 Unit : mm 單位 : 毫米

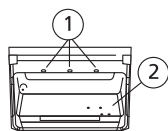

No.	Part 部件	No.	Part 部件
1	Sensor 感應器	5	Water Tray Unit 水箱
2	Drying Box 乾手部份	6	Indication Light 指示燈
3	Body 機身	7	Filter 過濾網
4	Front Case Cover 前蓋	8	Fixation Board 安裝板

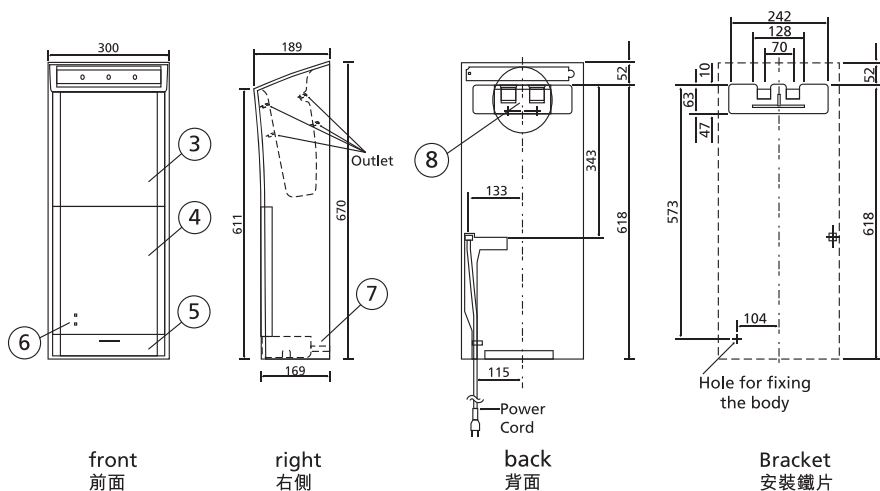

Recommended Installation Height (From the ground to the upper end of the suspension iron plate)
建議安裝高度 (從地面至懸掛鐵片上端)

For Men 男士用	875 mm (毫米)
For Women 女士用	855 mm (毫米)

Panasonic

Panasonic Ecology Systems Co., Ltd.

本產品目錄只供參考，資料已經過細心核對，如有錯漏，以廠方生產的規格為準。
本公司保留更改產品設計及規格之權利，恕不另行通知。
如有任何爭議，信興電器貿易有限公司保留最終決定權。

This catalogue is for reference only. The product information is subject to manufacturer specifications. The design and specifications of the products may be modified without prior notice. In case of any dispute, Shun Hing Electronic Trading Co., Ltd. reserves the right of final decision.



信興電器貿易有限公司
SHUN HING ELECTRONIC TRADING CO., LTD.
顧客服務熱線
Customer Service Hotline : 2833 0955

www.panasonic.hk

保養及維修 Maintenance and Repair Service:

信興電器服務中心有限公司
SHUN HING ELECTRIC SERVICE CENTRE LTD.
電話 Tel: (852) 2406 5666

此產品目錄以環保紙及墨印刷
Printed with environmental friendly ink on environmental paper.

CATALOG NO: P-HD004

PRINTED IN HONG KONG (05.12)

Panasonic

ideas for life

Jet Type Hand Dryer
噴射式乾手機

高雅 · 時尚

Turbo Airjet

NEW

FJ-T10T1



SUPER
alleru-buster



Panasonic 全新噴射式乾手機

實現 **5** 秒極速乾手效果^(*)
 Realizes **5**-second Rapid Drying with
 New Panasonic Jet Type Hand Dryer

Elegant and streamline design of Panasonic hand dryer
 upgrades the image of the washroom.

Panasonic 全新噴射式乾手機設計高雅時尚，
 令洗手間的形象煥然一新

- Attractive blue LED lighting.
- Attractive slim cut-line body with coating acts as the decoration items in the washroom.
- 2 colors are available to blend with the washroom design perfectly.
- 悅目的藍色 LED 燈。
- 誘人的纖薄流線機身，配合表面塗層，儼如洗手間的設計裝飾。
- 備有兩種顏色，讓你選擇可融入洗手間設計的色調。



white / 白



silver / 銀

(*) Drying time is calculated based on the measurement of our company. 乾手時間根據本公司量度而計算。

NEW Features 全新特點

1

Highly Efficient 效能卓越

- 5-Second Quick Drying • 5 秒速乾^{(*)1}
- Low Power Consumption • 低耗電量

Double-side and quad-row jet airflow of Panasonic Jet Type Hand Dryer enables shorter drying time at approximate 3-5 seconds to dry hands, with less power consumption. Compared with previous model, the new model can save up to 31% yearly power consumption^{(*)2} with 44% efficiency increased.

Panasonic 全新噴射式乾手機的兩面四排噴射氣流能以較小耗電量於 3-5 秒更短時間迅速吹乾雙手，與之前產品比較，新型號可以每年節省可達 31% 的耗電量^{(*)2}，並提升 44% 效率。

Dual wiping 雙重抹擦

- Upper nozzle 上排噴嘴**
Remove small droplets
吹乾細水滴
- Lower nozzle 下排噴嘴**
Remove large droplets
吹乾大水滴

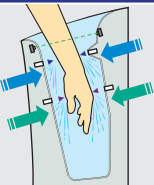

Double-side and quad-row nozzles enable dual wiping effect for excellent drying.

兩面四排氣流噴嘴實踐雙重抹擦效果，乾燥性能更特出。

Strong blow 強勁氣流

Current 舊型號



Diffusing 擴散

New (Upper Nozzle) 新型號 (上排噴嘴)



Straight Reaching 集中及遠程

Long 長噴口

Conical flask shaped nozzles generate strong blow airflow for jet drying effect.

長錐形噴嘴產生強勁氣流形成噴射乾燥效果。

Auto sensors 自動感應器

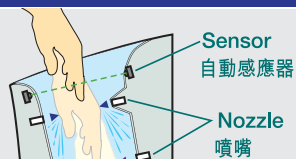

Auto sensors are perfectly situated over the nozzles to optimize quick drying operation. Together with jet airflow, high energy efficiency is achieved.

自動感應器的設置於噴嘴上方，配合噴射氣流，實現高能源效益。

^{(*)1} Drying time is calculated based on the measurement of our company. 乾手時間根據本公司量度而計算。

^{(*)2} Calculation based on usage at 400 times per day and 300 days per year. 以每日 400 次及每年 300 日使用量計算。

2

Smart Design 優化設計

- Low Noise • 低噪音
- LED Indication Light • LED 提示燈



V-taper drying chamber allows operation at lower noise level, that ensures more user-friendly.

Not only having a attractive look, the blue LED light also reminds you the elapsed time of drying.

獨特 V 形設計，在運行時產生較低的噪音，使用更舒適。藍色的 LED 燈不僅美觀，更可提醒您乾燥時間即將完畢。



The blue LED light will blink after drying for certain seconds, until the operation is stopped after 30 seconds.

乾燥操作若干秒後，藍色 LED 燈將閃爍，直到完成 30 秒運行後停止操作。

3

High Flexibility 靈活設定

Hand dryers would be used all year round. Functional selection of Panasonic hand dryer are significant for different environment.

乾手機一年四季都使用，Panasonic 乾手機可因應不同的環境來選擇使用功能。

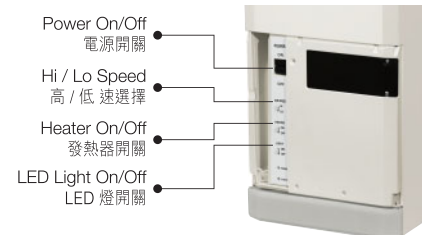

On/Off Switch for various functions lets you select your favorite operation 設置各種功能的開 / 關掣，讓你選擇最適合的運作。

Hygienic 清潔衛生

Warm and humid environment in washroom provide a greeding ground for bacteria. Panasonic hand dryer offers optimum level of hygiene for users. 洗手間的溫暖潮濕環境是霉菌的溫床，故令細菌容易滋生。Panasonic 乾手機為用家提供最佳的衛生水平。

- Sensor equipped offers touch free operation that reduce cross contamination from users.
- Anti-bacteria material is adopted at hand drying section in order to prevent the growth of bacteria and germs.
- Super alleru-buster filter is equipped to ensure the air blow to the hands is clean and healthy.
- 配備感應器自動操作，毋須觸摸機身，減少使用者的交叉感染。
- 乾手部份採用獨特防菌物料，防止細菌和病菌的生長蔓延。
- 備有超級抗菌過濾網，以確保吹出的氣流清潔乾淨。

What is Super alleru-buster?

Super alleru-buster can inhibit up to several types of allergen 使用超級抗敏過濾網，可抑制多種不同過敏原的活動

Phenolic Polymer • Polyphenol
石碳酸聚合物 • 抗氧化物質

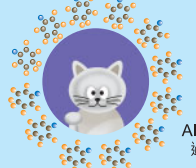

Allergen
過敏原



inhibit allergens
包裹過敏原 抑制其活動

Testing Organization: The Osaka Municipal Technical Research Institute.
Testing Method: to measure the level of reduction in cat's dandruff by Enzyme-linked Immuno Sorbent Assay.
試驗機構：大阪市立工業研究所 試驗方法：採用酵素免疫測定方法，測試貓毛屑的減少程度

Easy Maintenance 容易清理

- Slide-out designed water tray allows easy cleaning
- Water tray with 1-litre large volume capacity reduces the frequency of water disposal.
- Full tank indicator reminds for cleaning when it is full.
- 採用推拉式水箱設計，易於清理積水。
- 1 公升大容量水箱，減少處理積水的次數。
- 備有積水提示，水滿時可提醒清理積水。



Safe Operation 安全放心

- The unit is programmed to stop after 30 seconds of continuous operation.
- 'Check' sign will light up when the unit detects overheated.
- Closed-side drying chamber reduces excess water dripping on floor to avoid slippery.
- 乾手機會於連續運行 30 秒後自動停止。
- 當發熱器超出負荷時，安全指示燈會即是亮起。
- 兩邊封密設計，大大減少地面濕滑情況，避免意外發生。

Total Cost Comparison 總成本比較圖

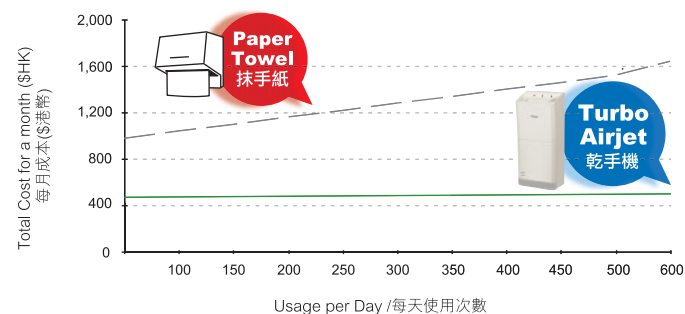

Remarks: Data is based on Hong Kong market situation. Below figures are used for reference only. 備註：以下計算是根據香港市場情況，並只作參考用途

Monthly Cost Calculation Based on 50 Usage Per Day 每月成本計算 (每天使用 50 次)

	Washtroom with Paper Towel 設有抹手紙之洗手間	Washtroom with Turbo Airjet 設有 Turbo Airjet 之洗手間
Material / Operation Cost 物料/運作成本	Paper towel costs \$0.045/pieces 1 paper towel is used each time 每次使用1張，每張約\$0.045 = \$0.045 x 50(usage/次) x 30(day/日) = \$67.5	Power consumption costs \$1.237 per kwh Operates 5 sec. per usage = 0.0014 hr Cost/usage = 1.237 x 0.0014 = \$0.0017 每次使用5秒，電費約\$1.237千瓦時 = \$0.0017 x 50(usage/次) x 30(day/日) = \$2.55
Labor Cost 工資成本	Labor cost for cleaning = \$30/hr Twice a day, 30 min./time = 30hrs/month 工人時薪\$30，每天清潔2次，每次約30分鐘 = \$30 x 30 = \$900	Labor cost for cleaning = \$30/hr Once a day, 15 min./time = 7.5hrs/month 工人時薪\$30，每天清潔1次，每次約15分鐘 = \$30 x 7.5 = \$225
Total Cost 總成本	Material Cost + Labor Cost 物料成本 + 工資成本 = \$67.5 + \$900 = \$967.5	Operation Cost + Labor Cost 運作成本 + 工資成本 = \$2.55 + \$225 = \$227.6