

## Operating Instructions Air Conditioner



### Model No.

#### Indoor Unit

CS-LV7SKA

CS-LV9SKA

CS-LV12SKA

#### Outdoor Unit

CU-LV7SKA

CU-LV9SKA

CU-LV12SKA



### 操作說明書

空調器

2,4-9

感謝您購買 Panasonic 空調器。

附帶安裝說明。

在操作空調器前，請細讀此操作說明，並保存此書以備日後參考。

### Operating Instructions

Air Conditioner

3,10-15

Thank you for purchasing Panasonic Air Conditioner.

Installation instructions attached.

Before operating the unit, please read these operating instructions thoroughly and keep them for future reference.

# 簡易指南

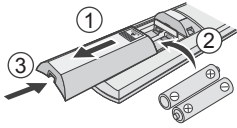

## 裝入電池

- ① 拉出遙控器的背蓋
- ② 裝入 AAA 或 R03 電池  
(可用大約一年)
- ③ 把蓋關上

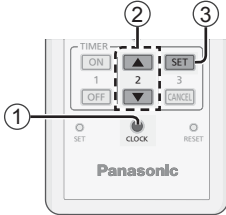

## 時間設定

- ① 按下 **CLOCK** (時間)
- ② 設定時間
- ③ 確認

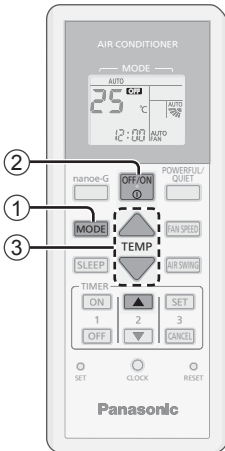

## 基本操作

- ① 選擇所需要的模式  
**AUTO** → **COOL** → **DRY**

- ② 開始/停止操作



- 請注意 **OFF** 指示燈顯示在顯示屏以啟動本機。

- ③ 選擇所需要的溫度

- 選擇範圍 **COOL/DRY** (製冷/除濕) 模式：  
16 °C ~ 30 °C。
- 在所建議的溫度範圍內操作本機可為您節省能源。  
**COOL** (製冷) : 26 °C ~ 28 °C。  
**DRY** (除濕) : 比室溫低 1 °C ~ 2 °C。

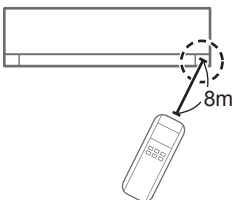

- 持續按下 **▲** 5 秒以調暗或恢復主機的指示燈亮度。

- 在室內機遙控接收器的 8 米範圍內使用遙控器。

本操作說明書裡的圖解僅作為說明用途，並且可能與實際產品有所區別。若因為產品改進而發生變更，恕不另行通知。

# Quick guide

## Inserting the batteries

- ① Pull out the back cover of remote control
- ② Insert AAA or R03 batteries  
(can be used ~ 1 year)
- ③ Close the cover

## Clock setting

- ① Press **CLOCK**
- ② Set the time
- ③ Confirm

## Basic operation

- ① Select the desired mode  
 AUTO → COOL → DRY  

- ② Start/stop the operation



• Please note that the **OFF** indication is on display to start the unit.

- ③ Select the desired temperature
  - Selection range for COOL/DRY mode: 16 °C ~ 30 °C.
  - Operating the unit within the recommended temperature range may save energy.  
 COOL: 26 °C ~ 28 °C.  
 DRY : 1 °C ~ 2 °C lower than room temperature.

• To dim or restore the unit's indicator brightness, press  and hold for 5 seconds.

• Use remote control within 8 m from the remote control receiver of the indoor unit.

The illustrations in this manual are for explanation purposes only and may differ from the actual unit. They are subject to change without notice for future improvement.

## 目錄

安全措施 .....	4-5
如何使用 .....	6-7
清洗說明 .....	8
故障檢修 .....	9
信息 .....	封底

## 附件

- 遙控器
- AAA 或 R03 電池 × 2
- 遙控器托架
- 用於遙控器托架的螺釘 × 2

## Table of contents



Safety precautions .....	10-11
How to use .....	12-13
Cleaning instructions .....	14
Troubleshooting .....	15
Information .....	Back cover

## Accessories

- Remote control
- AAA or R03 batteries × 2
- Remote control holder
- Screws for remote control holder × 2

# 安全措施

為了防止個人傷害，危害其他人或財物的損失，請遵守以下指示：  
因不遵守以下指示導致的錯誤操作將引起傷害或損壞，其嚴重程度分類如下：

	<b>警告</b>	此標識所示的行為有可能導致嚴重傷害或死亡。
	<b>注意</b>	此標識所示的行為有可能導致傷害或財產損失。

要遵守的指示按下列符號分類：

	此符號表示被禁止的行為。
   	此符號表示務必執行的行為。

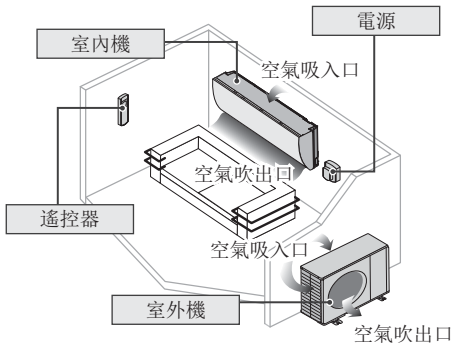

**警告**

## 室內機及室外機



此裝置不適合殘疾、感應欠佳或智障，經驗與知識不足的人士（包括兒童）使用。除非負責其安全的監督人從旁監督或指示如何正確使用此裝置。務必監督兒童以確保他們不會玩弄本機。

請諮詢授權經銷商或專業人員清潔內部零件，修理、安裝、拆卸和重新安裝本機。安裝及處理不當將導致漏電，觸電或火災。

請向授權經銷商或專業人員確認有關任何指定製冷劑類型之運用。使用所指定以外的製冷劑類型會導致產品損壞，爆裂並導致傷害等。



切勿將本機安裝在爆炸或可燃性的環境中。否則會導致火災。

切勿把手指或其他物件插入空調器的室內或室外機以免受到旋轉部件傷害。



閃電時切勿觸摸室外機，否則會導致觸電。

切勿長時間受冷氣流直接吹拂以免過冷。

切勿坐或踩踏在主機上以免意外摔跤。



## 遙控器



切勿讓嬰兒和小孩玩遙控器以免不小心吞下電池。

## 電源



切勿採用改裝電線，接合電線，延長電線或非指定的電線，以免過熱及火災。



為免過熱，火災或觸電：

- 切勿與其他設備共用一個電源插座。
- 切勿用潮濕的手操作。
- 切勿過度扭曲電線。
- 切勿以插入或拉出插頭的方式來操作或停止本機。



如果電線損壞，必須由製造商、其服務代理商或具有同等資格的合格人員進行更換以免遭受危害。

強烈建議您安裝接地漏電電源斷路器 (ELCB) 或殘餘電流裝置 (RCD) 以免觸電或火災。

為免過熱，火災或觸電：

- 妥當插入插頭。
- 務必定時用乾布擦掉插頭上的灰塵。

當出現任何異常/故障時，請停止使用本機，拔出電插頭或關掉電源開關及斷路器。

- (煙霧/火災/觸電危險) 異常/故障舉例
- 接地漏電電源斷路器 (ELCB) 頻繁跳開。
- 出現燒焦味。
- 本機出現異常噪音或振動。
- 室內機漏水。
- 電線或插頭變得異常熱。
- 無法控制風量。
- 本機立即停止運轉，雖然已經打開準備操作。
- 雖然已經停止操作，風扇仍然不停止轉動。

立即諮詢經銷商以進行保養/修理。

更換或安裝電源插頭必須由授權/合格人員進行。主導電體裏的電線由下列不同的顏色分類：

	接頭	電線	顏色 (GB 標準)
L	紅色	負載線	褐色
N	黑色	中線	藍色
E	綠色/黃色	接地線	綠色-黃色

電線顏色會隨國家電線代碼的標準而有所區別。



本設備必須接地以免觸電或火災。



為免觸電，請在下列情況時關閉電源並拔出插頭：

- 清洗或維修之前，
- 長期不使用時，或
- 異常強烈閃電時。



注意

## 室內機及室外機



切勿用水、苯、稀釋劑或潔亮粉末清洗室內機以免損壞或腐蝕本機。

切勿充作其他用途，如貯藏食物、動物、植物、藝術品或其他物件。否則會破壞品質等。

切勿在氣流出口使用任何易燃器具以免引起火災。

切勿讓植物或寵物受冷氣流直接吹拂以免損傷等。

切勿觸摸尖銳的鋁散熱片以免受到尖銳部件傷害。



當在地面打蠟時切勿 ON (開啟) 室內機。打蠟完畢之後，請先讓房間良好通風再操作本機。

切勿將本機安裝在油煙重的場所以免損壞本機。

切勿拆卸本機來進行清洗工作以免受傷。

當清洗本機時切勿踩踏在不穩固的架子上以免受傷。

切勿將花瓶或水容器放置在本機上。水會進入本機而導致絕緣受到破壞。這會引起觸電。

切勿在 COOL/DRY (製冷/除濕) 模式下長時間打開門窗。



為免漏水，請確保排水軟管：

- 連接正確，
- 不受通道及容器阻擋，或
- 不浸在水裏

長時間使用或與其他易燃設備一起使用後請定時讓房間通風換氣。

長期使用後，請注意安裝支架是否有損壞以免主機墜落。

## 遙控器



切勿使用可充電電池 (Ni-Cd)。它會損壞遙控器。



為免遙控器失靈或損壞：

- 如果準備長期不使用本機，務必將電池取出。
- 務必採用同類型的新電池並對準電極插入。

## 電源



切勿以抽拉電線的方式來拔除插頭以免觸電。

# 如何使用

## 以淨化空氣

### ▷nanoe-G

- 用  啟動本機時 nanoe-G 功能會自動開始操作。
- 此功能在本機關閉時依然可以啟動。在此情況下，本機將AUTO(自動)調節風量及擺動葉片並送風。

## 在濾塵網中消滅病毒/細菌

### ▷nanoe-G ● POWER

- 關閉本機後，nanoe-G 濾塵網抗菌功能可能會啟動達 150 分鐘。啟動本機取消本功能。

## nanoe-G 濾塵網抗菌功能

視本機的累積操作時間而定，在關閉主機後 nanoe-G 濾塵網抗菌功能可能會每天只啟動一次。為排除留在內部機件的濕氣，葉片將在稍微打開的情況下操作風扇送風 30 分鐘。此流程只會在主機關閉之前操作COOL/DRY(製冷/除濕)模式方為有效。之後，nanoe-G 將於停止風扇送風和關閉葉片的狀態下在濾塵網中消滅病毒/細菌達 2 小時。切勿在此功能操作中關閉電源。電源中斷後此功能操作將不恢復。

## 選擇運轉模式

### AUTO(自動) - 給您方便

- 本機將按照室溫自動選擇運轉模式。
- 一旦選取AUTO(自動)模式，本機將以標準設定溫度來運轉。

房間溫度	運轉模式	標準設定溫度
23 °C 及以上	COOL(製冷)	25 °C
23 °C 以下	DRY(除濕)	22 °C

- 按下  至 "HI" +2°C 或  至 "LO" -2°C 以獲取標準設定溫度。

### COOL(製冷) - 享受清涼

- 提供高效舒適製冷，以滿足您的需求。

### DRY(除濕) - 為您創造乾爽的環境

- 空調以低速運轉，進行極為柔和的製冷運轉。

## 睡眠時的最佳舒適度



- 此操作為您提供一個舒適的睡眠環境。在啟動期間，它會自動調整為睡眠模式的溫度。
- 當操作啟動時，室內機指示燈會變暗。如果指示燈亮度已手動調暗，此功能不適用。
- 這項操作含啟動計時器(0.5, 1, 2, 3, 4, 5, 6, 7, 8或9個小時)。
- 此操作可與單計時器或雙計時器一同設置。睡眠模式優先於OFF(關閉)計時器。
- 當睡眠計時器達0.0h時，可按各別相關按鈕以取消此操作。



遙控接收器及指示燈

- POWER (綠色)
- TIMER (橙色)
- nanoe-G (藍色)
- POWERFUL/QUIET (橙色/綠色)

遙控器顯示屏

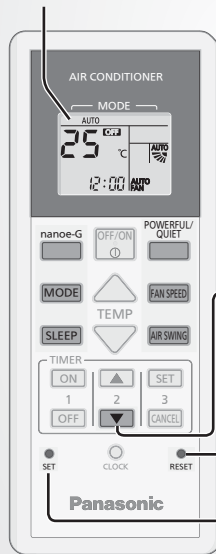

持續按下大約 10 秒以在 °C 或 °F 格式中顯示溫度。

按下以恢復遙控器的出廠設定。

在正常操作下不使用。

## 自動OFF/ON(關/開)按鈕



當遙控器遺失或失靈時使用。向上提起正面板：

- 在AUTO(自動)模式使用時，按一次按鈕。
- 在COOL(製冷)模式使用時，持續按下按鈕直到聽見一聲“嗶”，然後鬆開。
- 再按一次按鈕以關閉。

POWERFUL/  
QUIET

轉換於強勁和安靜之間



→ POWERFUL → QUIET → NORMAL

**POWERFUL:** 迅速達到設定溫度

☉ POWERFUL/QUIET

• 此運轉在 15 分鐘後自動停止。

**QUIET:** 享受安靜運轉

☉ POWERFUL/QUIET

• 此功能將減低氣流噪音。

FAN SPEED 選擇風量

(遙控器顯示屏)



• 至於AUTO(自動)運轉, 室內風扇風量將依據運轉模式自動調節。

AIR SWING 調節垂直風向

(遙控器顯示屏)



- 保持室內空氣循環。
- 在COOL/DRY(製冷/除濕)模式下, 如果設定為AUTO(自動)風向時, 葉片將自動向上/下擺動。
- 切勿用手調節葉片。

調節水平風向

• 可手動調節。

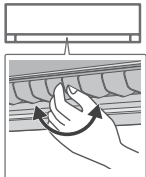

自動重新啟動控制

- 如果在電源中斷後恢復電源, 在一段時間後運轉將自動重新啟動於先前的運轉模式和風向。
- 當定時器被設置時此功能將無效。

注意

POWERFUL/  
QUIET

nanoe-G



• 可以在任何模式中操作。再分別按下相關的按鈕即可取消操作。

POWERFUL/  
QUIET



• 無法被同時選取。

設定預約時間

要在預設時間內ON(啟動)或OFF(關閉)主機時。

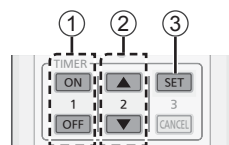

① 選擇ON(開機)或OFF(關機)模式

舉例:  
在 22:00  
OFF(關機)



② 設定時間



③ 確認



- 按 ON 或 OFF, 然後按下 CANCEL 以取消 ON(開機)或OFF(關機)定時預約時間。
- 當設定了定時ON(開機)時, 為了在您設定的時間內達到您所設定的溫度, 空調器會在設定的時間提前運轉(高達 15 分鐘)。
- 定時預約機能將依據遙控器所設定的時間操作, 並且一旦被設定後會每天重複操作。至於時鐘設定, 請參閱簡易指南。
- 如果自行取消定時預約或因為發生停電而被取消, 您可按下 SET 以恢復之前的設定(在電流恢復後)。

操作條件

在以下溫度範圍內使用空調器。

DBT: 乾球溫度

WBT: 濕球溫度

溫度 (°C)		室內		室外	
		DBT	WBT	DBT	WBT
COOL (製冷)	最高	32	23	43	26
	最低	16	11	16	11

# 清洗說明

為了確保本機發揮最佳性能，您必須進行定期清洗。請諮詢授權經銷商。

- 進行清洗前，關掉電源並拔出插頭。
- 切勿觸摸鋁片，尖銳部分會造成傷害。
- 切勿使用苯、稀釋劑或潔亮粉末。
- 僅使用肥皂（ $\approx$  pH 7）或中性家用清潔劑。
- 切勿使用溫度高過 40 °C 的水。

## 室內機

使用乾、軟的布輕抹。



## 正面板

輕洗並弄乾。

取出正面板

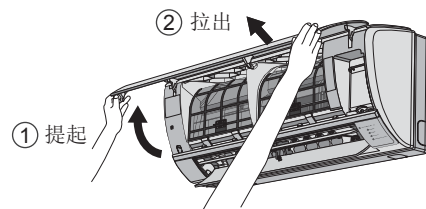

確實關上

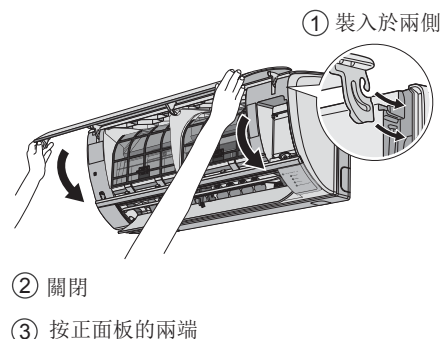

## 室內機

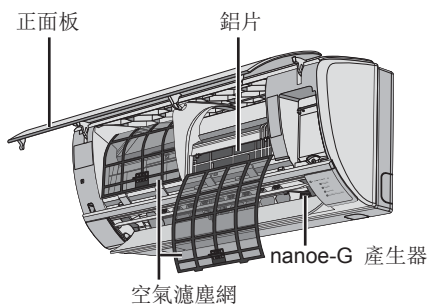

## nanoe-G 產生器

每 2 星期一次

- 使用乾棉花棒清洗。
- 運轉時切勿觸摸。

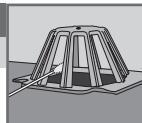

## 空氣濾塵網

每 2 星期一次

- 用水輕輕清洗/沖洗濾塵網以免損壞濾塵網的表層。
- 在陰涼處徹底弄乾濾塵網，遠離火源或直射陽光。
- 請更換損壞的濾塵網。



取出空氣濾塵網

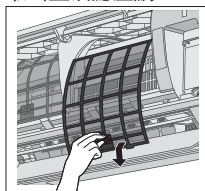

安裝空氣濾塵網

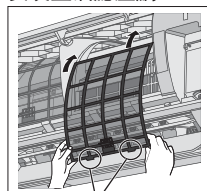

裝入主機

至於長期不使用時的換季檢查

- 檢查遙控器的電池。
- 確保室內機或室外機的空氣吸入或吹出口順暢無阻。
- 運轉 15 分鐘後，在正常情況下，室內機空氣吸入及吹出口的溫差為：

COOL (製冷):  $\geq 8$  °C

長期不使用時

- 啟動 nanoe-G 運轉 2 至 3 小時是徹底排除留在內部機件的濕氣，以防止微生物滋生。
- 關閉電源並拔出插頭。
- 取出遙控器的電池。



# 故障檢修

以下現象並非表示故障。

現象	原因
室內機散發出霧氣。	• 製冷導致冷凝現象。
運轉時，聽見類似流水聲。	• 機內製冷劑流動的聲音。
室內有異味。	• 這可能是牆壁、地毯、家具或衣物散發出來的氣味。
在自動風量設定中，室內風扇時開時停。	• 這是為了排除周圍所發出的異味。
重新啟動後，運轉延遲幾分鐘。	• 此延遲用於保護本機壓縮機。
室外機滴水/蒸氣。	• 這是配管表面水蒸氣冷凝或蒸發的現象。
TIMER(定時器)的指示燈一直亮。	• 一旦設定後，定時預約設定會每天重覆操作。
運轉時發出吱嘎噪聲。	• 溫度變化造成主機膨脹或收縮。
一些塑膠部件變色。	• 變色是受塑膠部件使用的材料種類影響。當暴露於熱、太陽光線、紫外線或環境因素會加速變色。
長期使用後，灰塵會積累在本機的正面板，格柵和四周牆壁。	• 灰塵積累的原因是 nanoe-G 的負離子產生的空氣淨化效果。定時用清潔的微濕布來清除灰塵。

在進行維修之前請先檢查以下各項。

現象	檢查
在COOL(製冷)模式運轉時無法有效地操作。	• 設定正確溫度。 • 關上所有房門及窗戶。 • 清洗或更換濾塵網。 • 移除阻擋空氣吸入或吹出口的任何阻礙物。
運轉時產生噪音。	• 檢查是否裝斜了主機。 • 妥善關閉正面板。
遙控器不操作。 (顯示屏變暗或傳輸信號微弱。)	• 正確地安裝電池。 • 更換微弱的電池。
本機不能啟動。	• 檢查是否是電流斷路器跳開了。 • 檢查是否已設定預約時間。
本機沒有從遙控器收到信號。	• 確認接收器不受阻礙。 • 某種類型的螢光燈可能會影響訊號接收。請諮詢授權經銷商。
運轉時室外機發出水濺聲。	• 這是因為採用了排水方式以發揮最佳性能。請諮詢授權經銷商以改裝排水方式。

## 不可維修的情況

若出現以下情況，請關閉電源並拔出插頭，然後諮詢授權經銷商：

- 運轉時發出異常噪音。
- 有水/異物進入遙控器。
- 室內機漏水。
- 電源斷路器經常跳開。
- 電線異常發熱。
- 開關鈕或按鈕不能正常操作。
- 主機停止操作及TIMER(定時器)指示燈閃爍(檢測到製冷劑不充足)。

# Safety precautions

To prevent personal injury, injury to others or property damage, please comply with the following: Incorrect operation due to failure to follow instructions below may cause harm or damage, the seriousness of which is classified as below:

	<b>WARNING</b>	This sign warns of death or serious injury.
--	----------------	---

	<b>CAUTION</b>	This sign warns of injury or damage to property.
--	----------------	--

The instructions to be followed are classified by the following symbols:

	This symbol denotes an action that is <b>PROHIBITED</b> .
--	---

	These symbols denote actions <b>COMPULSORY</b> .
--	--

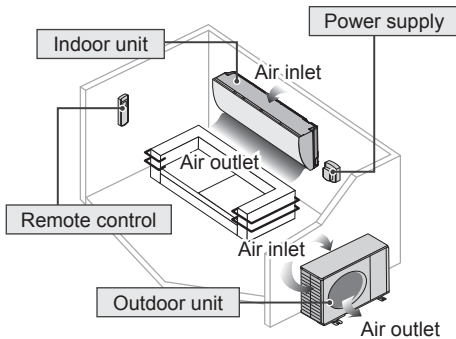

## WARNING

### Indoor unit and outdoor unit



This appliance is not intended for use by persons (including children) with reduced physical, sensory or mental capabilities, or lack of experience and knowledge, unless they have been given supervision or instruction concerning use of the appliance by a person responsible for their safety. Children should be supervised to ensure that they do not play with the appliance.

Please consult authorised dealer or specialist to clean the internal parts, repair, install, remove and reinstall the unit. Improper installation and handling will cause leakage, electric shock or fire.

Confirm with authorised dealer or specialist on usage of any specified refrigerant type. Using refrigerant type other than the specified may cause product damage, burst and injury etc.



Do not install the unit in a potentially explosive or flammable atmosphere. Failure to do so could result in fire.

Do not insert your fingers or other objects into the air conditioner indoor or outdoor unit, rotating parts may cause injury.



Do not touch the outdoor unit during lightning, it may cause electric shock.

Do not expose yourself directly to cold air for a long period to avoid excess cooling.

Do not sit or step on the unit, you may fall down accidentally.



### Remote control



Do not allow infants and small children to play with the remote control to prevent them from accidentally swallowing the batteries.

### Power supply



Do not use a modified cord, joint cord, extension cord or unspecified cord to prevent overheating and fire.



To prevent overheating, fire or electric shock:

- Do not share the same power outlet with other equipment.
- Do not operate with wet hands.
- Do not over bend the power supply cord.
- Do not operate or stop the unit by inserting or pulling out the power plug.



If the supply cord is damaged, it must be replaced by the manufacturer, service agent or similarly qualified persons in order to avoid a hazard.

It is strongly recommended to be installed with Earth Leakage Circuit Breaker (ELCB) or Residual Current Device (RCD) to prevent electric shock or fire.

To prevent overheating, fire or electric shock:

- Insert the power plug properly.
- Dust on the power plug should be periodically wiped with a dry cloth.

Stop using the product if any abnormality/failure occurs and disconnect the power plug or turn off the power switch and breaker.

(Risk of smoke/fire/electric shock) Examples of abnormality/failure

- The ELCB trips frequently.
- Burning smell is observed.
- Abnormal noise or vibration of the unit is observed.
- Water leaks from the indoor unit.
- Power cord or plug becomes abnormally hot.
- Fan speed cannot be controlled.
- The unit stops running immediately even if it is switched on for operation.
- The fan does not stop even if the operation is stopped.

Contact your local dealer immediately for maintenance/repair.

Replacement or installation of power plugs shall be performed by authorised/qualified personnel only. The wires in this mains lead are coloured in accordance with the following code:

Terminals	wires	colours (GB Standard)
<b>L</b>	Red	live brown
<b>N</b>	Black	neutral blue
<b>E</b>	Green/Yellow	earth green-yellow

Wiring colour may vary depending on a country wiring code's standard.



This equipment must be earthed to prevent electrical shock or fire.



Prevent electric shock by switching off the power supply and unplugging:

- Before cleaning or servicing,
- When extended non-use, or
- During abnormally strong lightning activity.



## CAUTION

### Indoor unit and outdoor unit



Do not wash the indoor unit with water, benzene, thinner or scouring powder to avoid damage or corrosion at the unit.

Do not use for preservation of precise equipment, food, animals, plants, artwork or other objects. This may cause quality deterioration, etc.

Do not use any combustible equipment in front of the airflow outlet to avoid fire propagation.

Do not expose plants or pet directly to airflow to avoid injury, etc.

Do not touch the sharp aluminium fin, sharp parts may cause injury.



Do not switch ON the indoor unit when waxing the floor. After waxing, aerate the room properly before operating the unit.

Do not install the unit in oily and smoky areas to prevent damage to the unit.

Do not dismantle the unit for cleaning purpose to avoid injury.

Do not step onto an unstable bench when cleaning the unit to avoid injury.

Do not place a vase or water container on the unit. Water may enter the unit and degrade the insulation. This may cause an electric shock.

Do not open window or door for long time during COOL/DRY mode operation.



Prevent water leakage by ensuring drainage pipe is:

- Connected properly,
- Kept clear of gutters and containers, or
- Not immersed in water

After a long period of use or use with any combustible equipment, aerate the room regularly.

After a long period of use, make sure the installation rack does not deteriorate to prevent the unit from falling down.

### Remote control



Do not use rechargeable (Ni-Cd) batteries. It may damage the remote control.



To prevent malfunction or damage of the remote control:

- Remove the batteries if the unit is not going to be used for a long period of time.
- New batteries of the same type must be inserted following the polarity stated.

### Power supply



Do not disconnect the plug by pulling the cord to prevent electric shock.

# How to use

nanoe-G



## To purify the air

nanoe-G

nanoe-G starts automatically when the unit is turned on with .

Can be activated even when the unit is turned off. In this condition, the unit will operate as a fan with AUTO fan speed and flap swing.

## To deactivate viruses/bacteria on the filter

nanoe-G ● POWER

After the unit is turned off, the nanoe-G in-filter deactivation may activate up to 150 minutes. Turning on the unit cancels this operation.

## nanoe-G in-filter deactivation

Depending on the unit's accumulated operation time, nanoe-G in-filter deactivation may activate only once a day after the unit turned off.

To remove the moisture left in the internal parts, the fan will operate for 30 minutes with flap opened slightly. This process only applicable when the unit is operated in COOL/DRY mode before turned off. Then, nanoe-G deactivates viruses/bacteria on the filter for 2 hours with fan stopped and flap closed.

Do not turn off the power supply during this operation. After power failure, this operation will not resume.

MODE

## To select operation mode

### AUTO mode - For your convenience

- Unit selects the operation mode according to the room temperature.
- Once AUTO mode is selected, the unit will operate at the standard setting temperature.

Room temperature	Operation mode	Standard setting temperature
23 °C & above	COOL	25 °C
Below 23 °C	DRY	22 °C

- Press for "HI" to +2 °C or for "LO" to -2 °C to the standard setting temperature.

### COOL mode - To enjoy cool air

Provides efficient comfort cooling to suit your needs.

### DRY mode - To dehumidify the environment

Unit operates at low fan speed to give a gentle cooling operation.

SLEEP

## To maximise comfort while sleeping



- This operation provides you with a comfortable environment while sleeping. It will automatically adjust the sleep pattern temperature during the activation period.
- The indoor unit indicator will dim when this operation is activated. This is not applicable if the indicator brightness has been manually dimmed.
- This operation is incorporated with the activation timer (0.5, 1, 2, 3, 4, 5, 6, 7, 8 or 9 hours).
- This operation can be set together with single timer or twin timer. Sleep operation has the priority over OFF timer.
- This operation can be cancelled by pressing the respective button when the sleep timer reaches 0.0h.



Remote control receiver and indicator

- POWER (Green)
- TIMER (Orange)
- nanoe-G (Blue)
- POWERFUL/QUIET (Orange/Green)

Remote control display



Press and hold for approximately 10 seconds to show temperature setting in °C or °F.

Press to restore the remote control to default setting.

Not used in normal operations.

## Auto OFF/ON button



Use when remote control is misplaced or a malfunction occurs. Raise the front panel:

- To use in AUTO mode, press the button once.
- To use in COOL mode, press and hold the button until 1 beep is heard, then release.
- Press the button again to turn off.



## To switch between powerful & quiet

→ POWERFUL → QUIET → NORMAL →

### POWERFUL: To reach temperature quickly

☉: POWERFUL/QUIET

- This operation stops automatically after 15 minutes.

### QUIET: To enjoy quiet operation

☉: POWERFUL/QUIET

- This operation reduces airflow noise.



## To select fan speed

(Remote control display)

→ AUTO FAN → [Fan speed icons]

- For AUTO, the indoor fan speed is automatically adjusted according to the operation mode.



## To adjust vertical airflow direction

(Remote control display)

→ AUTO → [Air swing icons]

- Keeps the room ventilated.
- In COOL/DRY mode, if AUTO is set, the flap swings up/down automatically.
- Do not adjust the flap by hand.

## To adjust horizontal airflow direction

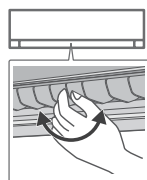

- Manually adjustable.

## Auto Restart Control

- If power is resumed after a power failure, the operation will restart automatically after a period of time with previous operation mode and airflow direction.
- This control is not applicable when TIMER is set.

### Note

POWERFUL/QUIET

nanoe-G

SLEEP

- Can be activated in all modes and can be cancelled by pressing the respective button again.

POWERFUL/QUIET

- Cannot be selected at the same time.

## To set the timer

To turn ON or OFF the unit at a preset time.

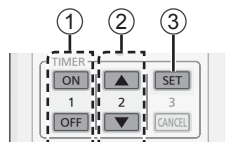

- 1 Select ON or OFF timer

Example:  
OFF at 22:00



- 2 Set the time



- 3 Confirm



- To cancel ON or OFF timer, press **ON** or **OFF** then press **CANCEL**.
- When ON Timer is set, the unit may start earlier (up to 15 minutes) before the actual set time in order to achieve the desired temperature on time.
- Timer operation is based on the clock set in the remote control and repeats daily once set. For clock setting, please refer to Quick guide.
- If timer is cancelled manually or due to power failure, you can restore the previous setting (once power is resumed) by pressing **SET**.

## Operation conditions

Use this air conditioner under the following temperature range.

DBT : Dry bulb temperature  
WBT : Wet bulb temperature

Temperature (°C)	Indoor		Outdoor		
	DBT	WBT	DBT	WBT	
COOL	Max.	32	23	43	26
	Min.	16	11	16	11

# Cleaning instructions

To ensure optimal performance of the unit, cleaning has to be carried out at regular intervals. Please consult authorised dealer.

- Switch off the power supply and unplug before cleaning.
- Do not touch the aluminium fin, sharp parts may cause injury.
- Do not use benzine, thinner or scouring powder.
- Use only soap ( $\approx$  pH 7) or neutral household detergent.
- Do not use water hotter than 40 °C.

## Indoor unit

Wipe the unit gently with a soft, dry cloth.



## Front panel

Wash gently and dry.

### Remove the front panel

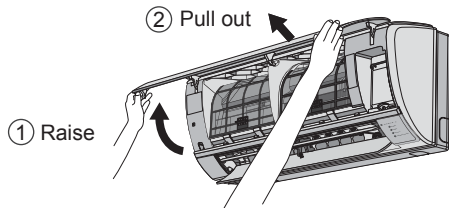

### Close it securely

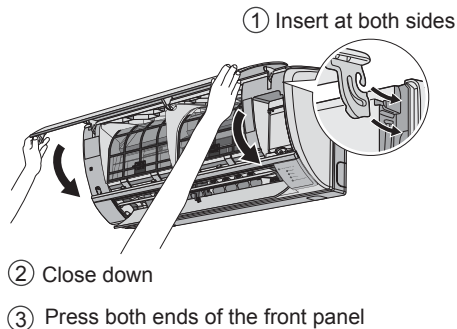

## Indoor unit

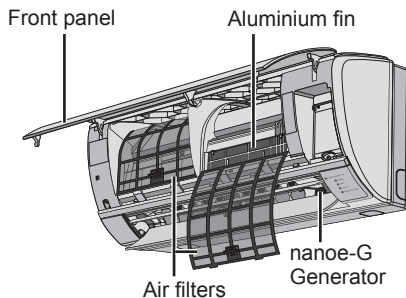

## nanoe-G Generator

Once every 2 weeks

- Clean with dry cotton bud.
- Do not touch during operation.



## Air filters

Once every 2 weeks

- Wash/rinse the filters gently with water to avoid damage to the filter surface.
- Dry the filters thoroughly under shade, away from fire or direct sunlight.
- Replace any damaged filters.



### Remove air filter

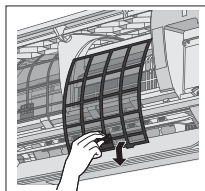

### Attach air filter

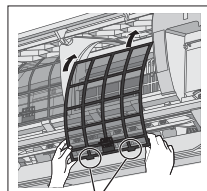

Insert into the unit

### For seasonal inspection after extended non-use

- Checking of remote control batteries.
- No obstruction at air inlet and air outlet vents.
- After 15 minutes of operation, it is normal to have the following temperature difference between air inlet and air outlet vents:

COOL:  $\geq 8$  °C

### For extended non-use

- Activate nanoe-G operation for 2~3 hours as an alternative to remove moisture left in the internal parts thoroughly to prevent mould growth.
- Turn off the power supply and unplug.
- Remove the remote control batteries.

# Troubleshooting

The following symptoms do not indicate malfunction.

Symptom	Cause
Mist emerges from indoor unit.	• Condensation effect due to cooling process.
Water flowing sound during operation.	• Refrigerant flow inside the unit.
The room has a peculiar odour.	• This may be due to damp smell emitted by the wall, carpet, furniture or clothing.
Indoor fan stops occasionally during automatic fan speed setting.	• This helps to remove the surrounding odour.
Operation is delayed a few minutes after restarting.	• The delay is a protection to the unit's compressor.
Outdoor unit emits water/steam.	• Condensation or evaporation occurs on pipes.
TIMER indicator is always on.	• The timer setting repeats daily once set.
Cracking sound during operation.	• Changes of temperature caused the expansion/contraction of the unit.
Discoloration of some plastic parts.	• Discoloration is subject to material types used in plastic parts, accelerated when exposed to heat, sun light, UV light, or environmental factor.
Dust may have collected around the front panel, grilles and wall surrounding the unit after extended use.	• The dust accumulation is due to air purification effect of negative ions from nanoe-G. Remove the dust regularly with a clean dampened cloth.

Check the following before calling for servicing.

Symptom	Check
Operation in COOL mode is not working efficiently.	<ul style="list-style-type: none"> <li>• Set the temperature correctly.</li> <li>• Close all doors and windows.</li> <li>• Clean or replace the filters.</li> <li>• Clear any obstruction at the air inlet and air outlet vents.</li> </ul>
Noisy during operation.	<ul style="list-style-type: none"> <li>• Check if the unit has been installed at an incline.</li> <li>• Close the front panel properly.</li> </ul>
Remote control does not work. (Display is dim or transmission signal is weak.)	<ul style="list-style-type: none"> <li>• Insert the batteries correctly.</li> <li>• Replace weak batteries.</li> </ul>
The unit does not work.	<ul style="list-style-type: none"> <li>• Check if the circuit breaker is tripped.</li> <li>• Check if timers have been set.</li> </ul>
The unit does not receive the signal from the remote control.	<ul style="list-style-type: none"> <li>• Make sure the receiver is not obstructed.</li> <li>• Certain fluorescent lights may interfere with signal transmitter. Please consult authorised dealer.</li> </ul>
Water splashing sound at outdoor unit during operation.	• This is due to drainage method is opted for maximise performance. Please consult authorised dealer to alter drainage method.

## NON SERVICEABLE CRITERIAS

TURN OFF POWER SUPPLY AND UNPLUG then please consult authorised dealer under the following conditions:

- Abnormal noise during operation.
- Water/foreign particles have entered the remote control.
- Water leaks from Indoor unit.
- Circuit breaker switches off frequently.
- Power cord becomes unnaturally warm.
- Switches or buttons are not functioning properly.
- The unit stops and the TIMER indicator blinks (insufficient refrigerant detected).

# 信息/Information

中文

## 關於用戶回收與丟棄舊設備及電池的信息



### [ 非歐共體國家的處理信息 ]

這些符號僅有效於歐洲共同體。如果您要丟棄這些物件，請諮詢您的當地政府或經銷商並詢問正確的丟棄方式。

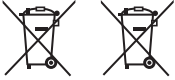

### 電池符號的注意事項（底部兩個符號舉例）：

此符號可與化學符號綜合使用。在此情況下，它須符合制定給該化學的使用條件。

Pb

English

## Information for Users on Collection and Disposal of Old Equipment and used Batteries



### [Information on Disposal in other Countries outside the European Union]

These symbols are only valid in the European Union. If you wish to discard these items, please contact your local authorities or dealer and ask for the correct method of disposal.

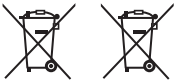

### Note for the battery symbol (bottom two symbol examples):

This symbol might be used in combination with a chemical symbol. In this case it complies with the requirement set by the Directive for the chemical involved.

Pb

Panasonic Corporation

Website: <http://www.panasonic.com>

© Panasonic Corporation 2016

Printed in Malaysia

ACXF55-00660

SS0116-0