

## 4.1.2 CS-YS18UKA

<Top View>

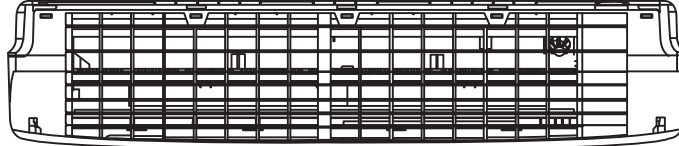

<Side View>

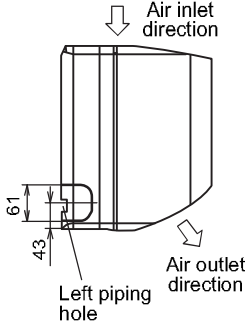

<Front View>

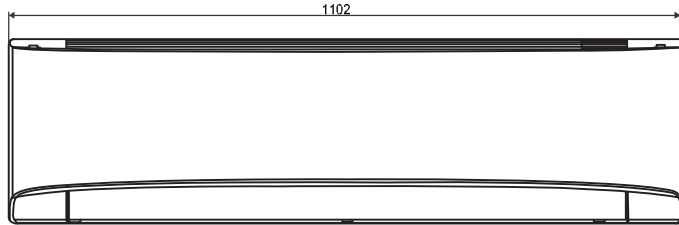

<Side View>

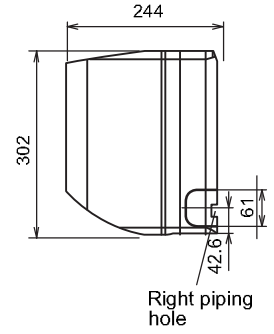

<Bottom View>

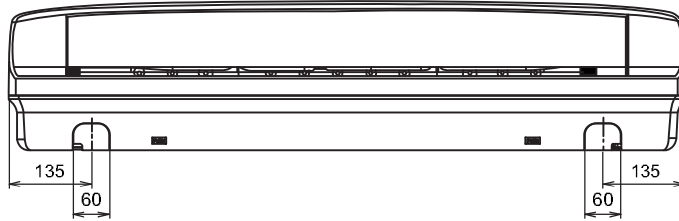

<Remote Control>

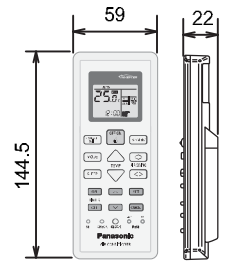

<Rear View>

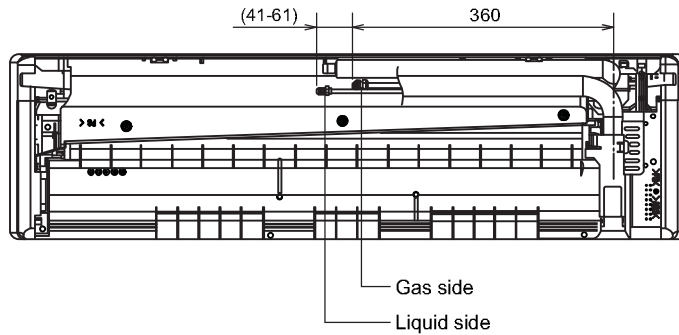

<Remote Control Holder>

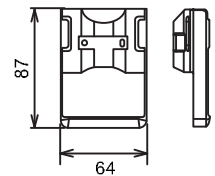

Relative position between the indoor unit and the installation plate <Front View>

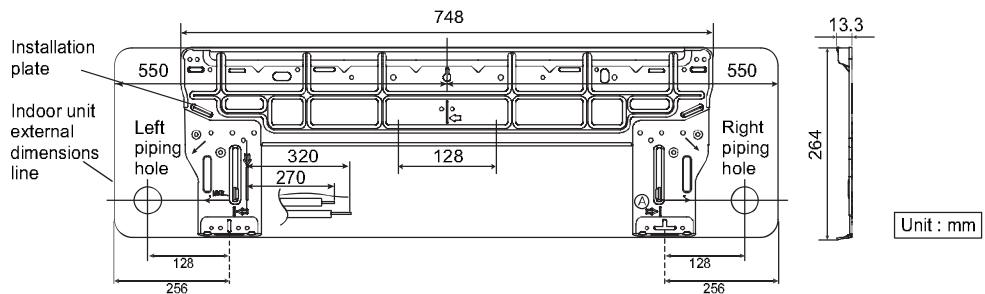

# CU-YS18UKA

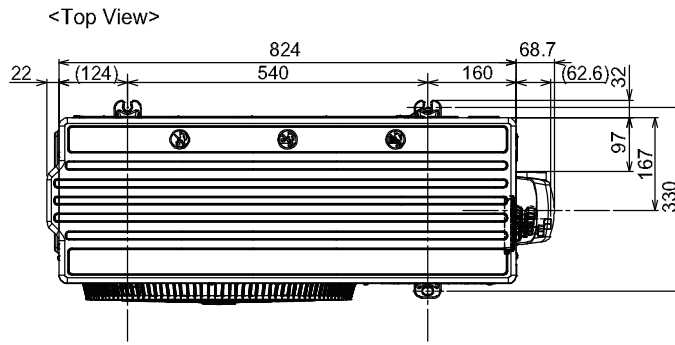
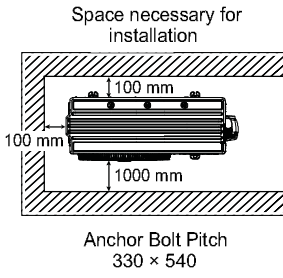

<Side View>

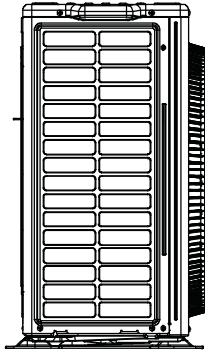

Unit : mm

<Front View>

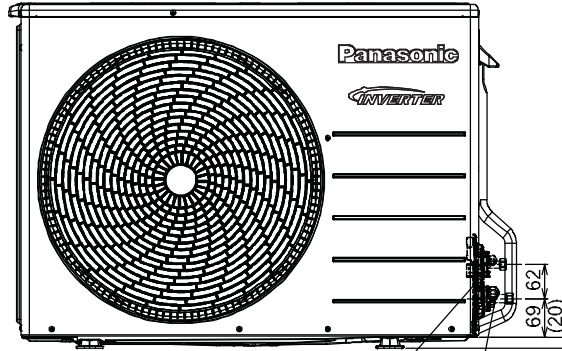

3-way valve at Gas side  
(Low Pressure)  
2-way valve at Liquid side  
(High Pressure)

<Side View>

