



Panasonic®

Operating Instructions Refrigerator

For Household Use

Model No.: NR-BV360Q, NR-BV320Q, NR-BV280Q



Contents

- Safety precautions..... 2
- Usage precautions 4
- Installation 6
- Parts identification 7
- ECONAVI operation 8
- Temperature control 8
- Temperature control (Fine adjustment mode) 9
- Quick Freezing 9
- Prime Fresh+ 10
- Prime Fresh room..... 10
- Food storage in the Freezer room..... 10
- Usage tips 11
- How to clean the refrigerator 12
- Troubleshooting 14
- Specifications 15

■ **NON-CFC**
 This unit uses totally **NON-CFC MATERIALS** both for refrigerant (R600a) and for insulation (Cyclo-Pentane). So, this refrigerator does not damage the Earth's ozone layer.

Thank you for purchasing the Panasonic product.
 • Please read these instructions carefully and follow safety precautions on page 2-5 before using this product.
 • Please make sure the date and name of store of purchase are stamped in warranty card and keep it with this operating instructions.

HK

ARAH1E202360
P0820-0
Printed in Vietnam

Safety precautions

Please be sure to follow these instructions.



WARNING

This sign means: It may lead to a serious injury or death.



These signs mean prohibited action.



This sign means required action.



This sign means the appliance must be earthed to prevent electric shock.



CAUTION

This sign means: It may result in injury or property damage.



iso-butane

Risk of fire / flammable materials

Otherwise it may cause a fire, injury, electrical shock.



WARNING

For power plug and cord...



- Do not plug or unplug with wet hands.
- Do not let the cord or plug be damaged.



- Disconnect power plug when cleaning.
- Plug into a wall outlet of the rated voltage on its own with the rated current and insert plug fully.
- Reserve one socket for the refrigerator only. Avoid connecting many appliances to the same socket and unroll through the length of cord.
- Remove dust periodically from the power plug.
- If the supply cord is damaged, it must be replaced by the manufacturer, its service agent or similarly qualified persons in order to avoid a hazard.
- If you detect burning smell, disconnect the power plug and ventilate the kitchen.
- **Stop** using the refrigerator and unplug the unit immediately if there is an abnormality or failure. Abnormality and failure examples:
 - Power cord or plug is abnormally hot.
 - Power cord is deeply cut or deformed.
 - There is burning smell.
 - You can feel tingling electricity.

When recycling the product...



- Before taking the refrigerator to be recycled, please remove all the door opening seal to prevent locking a child in it.
- The warning labels mentioned above should be kept throughout the life of the refrigerator.
- The operating instructions should be handed over to any person who would use or handle the refrigerator whenever the refrigerator would be transferred to another location and delivered to a recycling plant.
- Regarding to local laws, Cyclo-Pentane is used for insulation of this refrigerator. When you throw away this unit, please discard it by proper method and do not dispose it by burning.

Otherwise it may cause a fire, injury, electrical shock.



WARNING

When using...



- **Do not** damage the cooling circuit (piping on the back).
- **Do not** touch the compressor and pipes, because of high temperature, that there is a risk of burn injury.
- **Do not** let any children hang onto the refrigerator's door, it may overturn to the kid.
- **Do not** place any water container on the top of the refrigerator in case the spilling water causes electrical shock or combustion.
- **Do not** store explosive substances such as aerosol cans with a flammable propellant in this appliance.



- This appliance is not intended for use by persons (including children) with reduced physical, sensory or mental capabilities, or lack of experience and knowledge, unless they have been given supervision or instruction concerning use of the appliance by a person responsible for their safety.
- Children should be supervised to ensure that they do not play with the appliance.

In case of emergency...



- Maintenance work only be carried out at workshop by well-trained maintenance worker.



- **Do not** store explosive substances such as aerosol cans with a flammable propellant and chemicals or scientific specimens in the appliance.
- **Do not** use electrical appliances such as a deodorizer in the refrigerator. Leaked refrigerant may catch fire from a spark of the electrical contacts and may cause an explosion.
- **Do not** use electrical appliances inside the food storage compartments of the appliance, unless they are of the type recommended by the manufacturer.



- **Do not** disassemble, repair or modify the refrigerator by yourself. If you want to repair the refrigerator, please consult your dealer or authorized service center.
- **Do not** use mechanical device or other means to accelerate the defrosting process, other than those recommended by the manufacturer.

When installing...



- Fix the refrigerator to avoid danger due to unbalance.
- When positioning the appliance, ensure the supply cord is not trapped or damaged.



- Ensure that the refrigerator is plugged into an earthed mains socket.

Otherwise it may cause injury, accidents.



CAUTION

When opening/closing the doors...



- While opening the refrigerator, be careful not to pinch other one's hand holding the door.
- Mind the gap between the doors. They may nip your hand while closing the door.

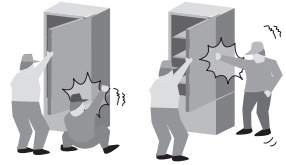

When storing food...



- **Do not** freeze glass bottles, that there is a risk of injury. (If the liquid in a glass bottle is frozen, then the bottle may break and you may be injured.)
- **Do not** add a high impact on glass trays. (Otherwise those glass trays may break and you may be injured.)



When moving the refrigerator...



- Hold the refrigerator tightly when transporting.
- Apply protective covering, etc. to floors with a fragile surface.



Usage precautions

When opening/closing the doors...

- **Do not** refrigerate items which are bigger than tray or shelf, as the door will not close completely causing leakage of cool air.
- **Do not** open refrigerator frequently or leave it open for long time in order to prevent water dripping inside and waste energy.
- Frequently check the door opening seal, it must be closed to the refrigerator's body completely.

When cleaning...

- **Do not** clean the refrigerator with chemical substance or liquid. It will cause damage and have corrosion on the surface.
- Clean the pan water evap located over the compressor at the back of the refrigerator every three months to prevent the odour generated from humidity.



Usage precautions

When using...

- When the plug is disconnected, leave it for 5 minutes before plugging again. If not, the compressor may not work.
- Adjust the temperature according to the actual operating condition for energy saving.
- The humidity inside the fresh case may condense so wipe it with a cloth periodically. Clean the fresh case once a month.
- If you will not be at home for several days and there are nothing refrigerated in the refrigerator, the plug should be disconnected for energy saving.
- The outside wall of refrigerator cabinet may sometimes get warm, especially just after installation. This is quite normal, and is due to the built-in Mullion Dryer Pipe which prevents sweating and radiates heat.
- When humidity is high, e.g. during rainy-season, condensation may appear on the surface of cabinet, especially around the door seal gasket. Wipe off the condensed water with a clean cloth.
- **Do not** keep the door open any longer than necessary, particularly in hot, humid weather.



When storing food...

- **Do not** place warm/hot foodstuff in the refrigerator.
- **Do not** overload the refrigerator. Gap must be provided between foodstuffs to maintain the cooling effect.
- Store fruits and vegetables in vegetable case, where trapped moisture helps preserve food quality for longer time periods.
- Drinking water, beverage bottles should be sealed to prevent odor contamination.
- Foodstuff such as vegetable, fruits and fresh food should be wrapped or pack in box before freezing and refrigerating.
- Put the food such as meat or fish in the freezer if you want to store for an extended period.
- Cover juicy food with tight lids, plastic film or foil.
- Cool hot dishes in room temperature before placing them in your refrigerator.



SPECIAL FEATURE

1) ECONAVI

The microchip performing ECONAVI mode is integrated into the main control board. By detecting refrigerator's frequency of use (opening and closing of door), ECONAVI mode automatically operates to save energy.

2) INVERTER

In accordance with temperature change inside the compartment, the motor of compressor runs at different speed. When the temperature is stable, the motor runs at a lower speed (energy saving & lower noise). When powerful cooling is required, the motor runs at a higher speed.

Installation

The distance requested for installation

- The top of the refrigerator and the ceiling at least 30 cm.
- The back of the refrigerator and the wall at least 10 cm.
- The sides of the refrigerator and the walls at least 5 cm.

Area around the installed unit

- **Do not** locate the refrigerator in a humid place as rust may form and may cause electric leakage.
- **Do not** locate the refrigerator exposing to direct sunlight as the heat and sunlight will increase the temperature.
- **Do not** locate the refrigerator near heat source such as cooking stove or oven.
- **Do not** block the openings around the refrigerator.
- The refrigerator must be located in the place where there is good air circulation.
- In case of placing the refrigerator on an uneven surface, adjust the adjustable bolt to make the refrigerator stands stably.

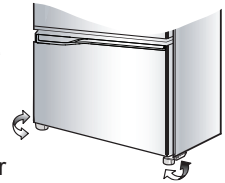
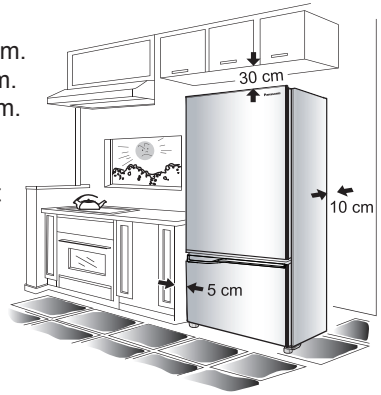

Moving or shifting

- When moving or shifting the refrigerator, remove ice maker, freezer case, pan water evap, etc. and check to be sure that there is no water in the refrigerator.

Power cord setting

- To bring power cord for use, pan water evap from left should be lifted up. Then bring the power cord out and then insert pan water evap into the block by pressing at both the sides.

LED lamp and grounding

- The refrigerator LED lamp, specially designed for this refrigerator, does not function on individual replacing.
If you need replacement, please contact Panasonic Service Center.
- If there is no grounding wiring plug in refrigerator, it should be connected with grounding connection to prevent electrical hazard from electric leakage.

Parts identification

- Ⓐ FRIDGE ROOM
- Ⓑ PRIME FRESH ROOM
- Ⓒ FREEZER ROOM
- ① LED Lamp
- ② PC Glass tray
- ③ Control Panel
- ④ Glass tray crisper
- ⑤ Vegetable case
- ⑥ Prime Fresh case
- ⑦ 1-2 Glass tray
- ⑧ Ice maker
- ⑨ Ice cube tray
- ⑩ Ice box
- ⑪ FC Glass tray
- ⑫ Freezer case
- ⑬ Egg shelf
- ⑭ Utility box
- ⑮ Egg tray
- ⑯ Bottle shelf
- ⑰ Shelf FC
- ⑱ Adjustable bolt
- ⑲ Gasket PC
- ⑳ Gasket FC
- ㉑ Pan water evap
- ㉒ Compressor

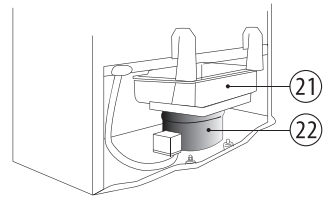
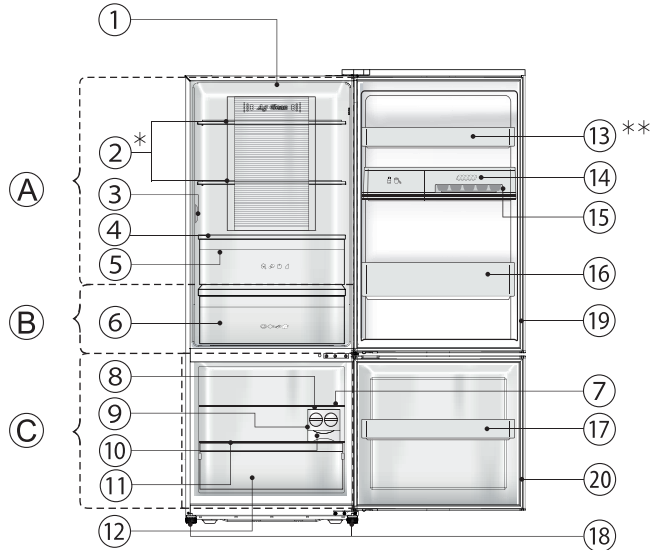

Product view from behind

* In model NR-BV280Q there is only 1 PC Glass tray.

** In model NR-BV280Q there is no egg shelf.

③ Control Panel

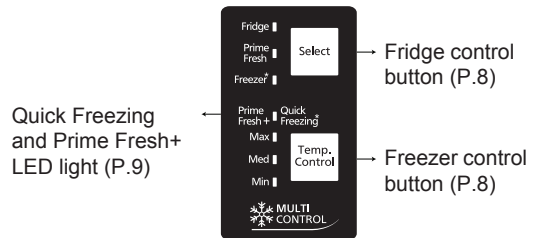

ECONAVI operation

Detect opening and closing of door and brightness around refrigerator, and automatically controls operation to save energy¹.

ECONAVI operation

- This refrigerator will learn the lifestyle patterns of your family from opening and the time periods of infrequent use to perform ECONAVI operation.
- The refrigerator learns your lifestyle pattern from the previous 3 weeks, and uses what it has learned from the 4th week onwards.

Setting for enabling ECONAVI operation

- ECONAVI operation is enabled automatically only when the temperature control of the Freezer room is set to "Med".
- However, ECONAVI does not operate while "Quick Freezing" or "Prime Fresh+" mode is operating.
- It is not possible to forcefully start ECONAVI operation.

Remark:

¹ Effectiveness differs depending on the ambient temperature, ambient brightness, number of times and when doors are opened and closed, and state in which food is stored.

Temperature control

The temperature can be adjusted for Min - Max levels. Press "Select" to select the area to control the temperature: Fridge, Prime Fresh, Freezer. After that, press "Temp Control" to set the temperature level.

"Fridge"	"Max" lower than "Med" by 2°C ~ 3°C
	"Med" approx. 1°C ~ 6°C
	"Min" higher than "Med" by 2°C ~ 3°C
"Prime Fresh"	"Max" lower than "Med" by 2°C ~ 3°C
	"Med" approx. -5°C ~ -1°C
	"Min" higher than "Med" by 2°C ~ 3°C
"Freezer"	"Max" lower than "Med" by 2°C ~ 3°C
	"Med" approx. -23°C ~ -17°C
	"Min" higher than "Med" by 4°C ~ 5°C

Remark:

While operating the refrigerator for the first time, after connecting the plug, adjust the temperature to "Med" position of each control and leave it for 24 hours for the effective cooling operation. After that, adjust the temperature as you prefer. If you want to save energy, do not adjust the temperature lower than the actual operating condition.

Temperature control (Fine adjustment mode)

















The refrigerator is specially designed for appropriate use, which can adjust the temperature level to detailed 9 levels with the following details.

How to operate the fine adjustment mode

For the Freezer room

1. Press the button “Select” until LED “Freezer” turns on.
2. Set LED display to “Min” with the “Temp. Control” button.
3. Press and hold the “Temp. Control” button (for a few seconds) until the LED display return to show at “Med” position.
4. Set “9 levels” mode following below table mentioned by pressing the “Temp. Control” button.

■ LED Display table

Cooling level	Minimum  Maximum									
	1	2	3	4	5	6	7	8	9	
Levels	1	2	3	4	5	6	7	8	9	
LED Display	Max □ Med □ Min □	Max □ Med  Min □	Max □ Med  Min □	Max □ Med  Min 	Max □ Med  Min □	Max  Med  Min □	Max  Med  Min □	Max  Med  Min □	Max  Med  Min □	Max  Med  Min □

 Lighting

 Blinking

 Not lighting

For the Fridge room

Operate above 1 ~ 4 steps with selecting “Fridge” area instead of “Freezer” area.

To reset the setting fine adjustment mode

Repeat step 1 ~ 3, then the refrigerator return to normal operation mode.

Remark:

- Prime Fresh room does not have fine adjustment mode.
- Temperature control varies depend on the changing of environment and food storage quantity.

Quick Freezing

How to operate the “Quick Freezing” mode

- Press the button “Select” until the LED “Freezer” turns on, then press “Temp Control” until the LED “Quick Freezing” turns on. “Quick Freezing” mode starts after 10 seconds.

Remark:

- If you want to stop the operation immediately, repeat the procedure until the LED “Quick Freezing” turns off.
- The system will stop the operation automatically when it runs for 60 mins (as ambient temperature is below 18°C) or 150 mins (as ambient temperature is above 18°C) and return to normal mode (the LED “Quick Freezing” turns off.)
- The LED “Quick Freezing” flashing means that the defrosting system is now working. “Quick Freezing” mode will start right after the defrosting operation is finished.

Prime Fresh+

How to operate the “Prime Fresh+” mode

- Press the button “Select” until the LED “Prime Fresh” turns on, then press “Temp Control” until the LED “Prime Fresh+” turns on.

Remark:

- If you want to stop the operation immediately, repeat the procedure until the LED “Prime Fresh+” turns off.
- The system will stop the operation automatically when it runs for 105 mins (as ambient temperature is below 18°C) or 150 mins (as ambient temperature is above 18°C) and return to normal mode (the LED “Prime Fresh+” turns off.)
- The LED “Prime Fresh+” flashing means that the defrosting system is now working. “Prime Fresh+” mode will start right after the defrosting operation is finished.

Remark:

When “Prime Fresh+” mode is active, if you set the “Quick Freezing” mode, the “Prime Fresh+” mode will stop and fridge activates “Quick Freezing” mode and vice versa.

Prime Fresh room

- This room is suitable for storing fresh food such as meat or fish.
Compared to storing in the Fridge room, the storage life of meat or fish becomes longer.
- When food is frozen too much...
Sliced raw fish or meat may be frozen too much.
Set the temperature control to “Min” to prevent food from over frozen.
- When food is not partially-frozen...
Depending on the type of food such as a block of meat or a large fish, the storage conditions and the ambient temperature, food may not be partially-frozen as it intended. Set the temperature control to “Max”.

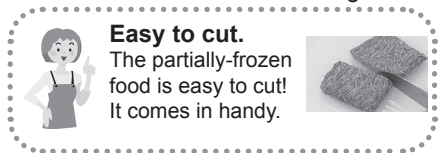

Food storage in the Freezer room

Freezer case

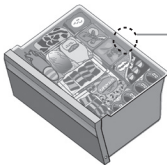

Maximum storage

If the stored food exceeds edge of container, the freezer door can not close completely and the room may become frosted.

How to make ice cubes with ice maker



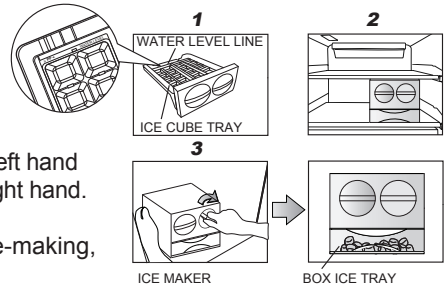

STEP

1. Fill water in the ice cube tray till the water level line.
2. Put ice cube tray inside Freezer room, wait until ice is made.
3. To remove ice cubes, suppress the frame with left hand and twist the dial ice cube tray clockwise with right hand. The ice cubes will drop into the box ice tray.

Remark: Don't pour water into ice box for ice-making, otherwise the box may crack.

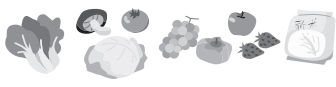

Usage tips

Fridge room	<p>“Processed food and drinks...” For regular storage of food and drinks or temporary storage of those to be served soon.</p> 
Utility box	<p>“Egg and cosmetics...” To prevent odors from spreading inside the Fridge room.</p> 
Vegetable case	<p>“Fruits and vegetables” A rather high humidity keeps fruits and vegetables fresh and juicy.</p> 
Prime Fresh room	<p>“Fresh food...” For storage of fresh food such as meat or fish for 1 week with soft freezing.</p> 
Freezer room	<p>“Dried or frozen foods...” For storage of food for an extended period.</p> 



Storage using hermetically sealed containers is recommended!

To prevent the interior from being discolored!



- Cut citrus fruits
(→ The plastic will be discolored white.)

To prevent odors from spreading!



- Garlicy or other strong smelling vegetables
(→ Odors will spread to other nearby food.)

How to clean the refrigerator

1 Interior cleaning

Wipe off the stain with warm water. When stains can not be removed easily, wipe them with warm water and soap by using a soft cloth. Then wipe the soap off using damp soft cloth.

2 Exterior cleaning

Cleaning by using soft cloth with warm water and soap. Then wipe off the soap with warm soft cloth.

3 Gasket door FC/PC

- Clean by wiping gently. This area, petroleum gel was applied to reduce the friction to the refrigerator body. Be careful not to wipe off them.
- The door opening seal is replaceable when reaching end of life. While cleaning, push it back to the groove if it comes off.



Note: Do not use the following items. (Otherwise, the surface will be scratched.)



Alkaline or weak Alkaline

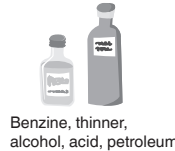

Removing vegetable case, Prime Fresh case and Freezer case for cleaning

• Removing

1. Pull the case until it reaches the end of stopper.
2. Raise up the front of case a bit and then completely take out.

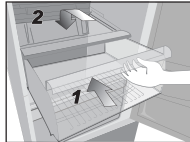
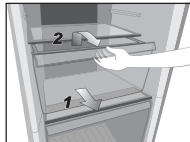

• Attaching

1. Push the case on both supporters.
2. Raise it up, then push until it reaches the end.

Removing egg shelf, bottle shelf, shelf FC and utility box for cleaning

• Removing

1. Lift it upward, alternating between the right and left side.

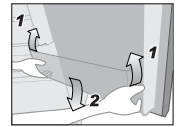

• Attaching

2. Placing it on both supporters, and then press until it reaches the end of supporters.

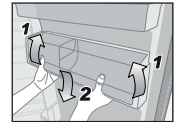

How to clean the refrigerator

Removing PC glass tray for cleaning

• Removing

1. Unhook the protrusion at the back by lifting it upward and pulling the tray outward until removing.

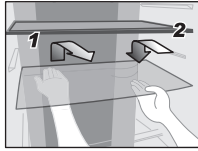

• Attaching

2. Push the tray until it reaches the end.

Remark:

- When removing tray above vegetable case, please pull out the vegetable case first and then follow to remove the tray as above details.
- In case of attaching the tray and it does not lock, make sure that you did not attach the wrong tray.
- Make sure that you don't attach the upper side of the tray downward.
- Two PC Glass trays can be used alternatively, but Glass tray crisper should only be attached right above vegetable case.

Removing FC glass tray for cleaning

• Removing

1. Unhook the protrusion at the back by lifting it upward and pulling the tray outward until removing.

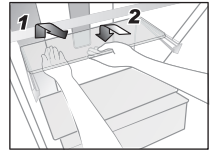

• Attaching

2. Push the tray until it reaches the end.

Remark:

- In case of attaching the tray and it does not lock, make sure that you did not attach the wrong tray.
- (In case of 1-2 Glass tray) In order to expand storage space inside Freezer room, the front tray can be removed and stacked with the other tray.

Removing pan water evap for cleaning

• Removing

1. Tilt up the pan water evap a bit and then lift it upward until the pan water evap hole unlocks from the pan water evap hook.
2. Pull the pan water evap until it touches with the evap pipe then carefully take it out under the evap pipe.

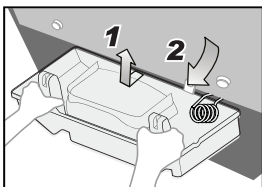

• Attaching

1. Insert the pan water evap under the evap pipe.
2. Insert the pan water evap hole into the hook pan water evap as well as press-fitting both sides.

Remark: Check the status to make sure evap pipe does not touch the pan water evap.

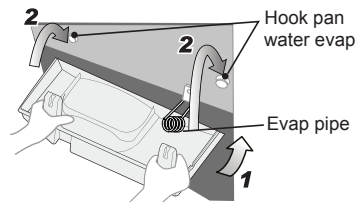

Troubleshooting

Before you call for service, please check the following items:

The refrigerator does not operate.

- Check that the plug and its socket are in good condition.
- Check if there is any problem on main fuse and electrical system of the house.
- Check by unplugging and wait for 5 minutes before plugging it back in.

The refrigerator does not cool enough.

- Check to be sure that light in control panel is displayed at proper position.
- Check to see if the refrigerator is overloaded with stuff or there is any hot foodstuff refrigerated inside.
- Is the refrigerator exposed directly to sunlight or heat source?
- Is the refrigerator door completely closed?
- Is the refrigerator door opened frequently?

Dew, snow appear.

Outside

- When the ambient humidity is too high, the door gasket may have dew. This situation will be stopped if the air humidity decreases. Please wipe it up with dry cloth.

Inside

- Is the door closed firmly?
- Is the door being opened and closed too frequently?
- When too high weather humidity, long opening time or making too much ice, inside the freezer compartment may appear frozen snow. This is normal. Please wipe with dry and soft cloth.

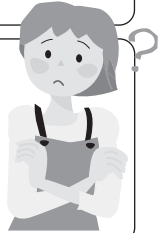

The refrigerator makes noise.

- Check if the refrigerator is located on a stable floor or is installed properly.
- Check if there is any object in contact with the refrigerator.
- Check if evap pipe in contact with pan water evap.

Food becomes frozen.

- Do you put the food near cold air holes?
- Do you adjust the temperature control at "Max"? Adjust to "Min"?
- Do you put food in prime fresh room?

The inside is smelling.

- Do you store the odour food without wrapping it?

The surfaces of the refrigerator is hot.

- Because the refrigerator is equipped with the dew prevention and heat radiation tubes, the surfaces of the refrigerator get warmer when operating.
- The back and side plates may get warmer especially when starting up or if the door is frequently opened and closed.

Troubleshooting

The normal sounds of refrigerator.

- When the refrigerator starts operation, the sound like water flowing and boiling water is created. This is the sound of the cooling liquid.
- The noise is generated when the automatic defrost system operated.
- The dilatation of the details inside the refrigerator in the cooling process can cause sound “crack-crack”.
- You may feel that the operation sound is larger because the compressor operates in high-speed under the following conditions: the refrigerator does not cool fully on the occasion such as using it for the first time, opening/closing the door too frequently, the surrounding temperature is high. The sound becomes more quiet after cooling fully.

Lamp does not turn on.

- Please contact Panasonic service center.

Specifications

Model No.		NR-BV360Q	NR-BV320Q	NR-BV280Q
Freezer Star Rating		✱✱✱✱		
Capacity (L) Gross/ Storage (IEC 62552)	Total	358 / 312	322 / 278	286 / 242
	Freezer	104 / 78		
	Fridge, Prime Fresh	254 / 234	218 / 200	182 / 164
Outside dimensions Width x Depth x Height (mm)		601 x 656 x 1785	601 x 656 x 1645	601 x 656 x 1505
Net weight (kg)		58	56	52
Cooling System		Frost-free system		
Refrigerant Type		R600a		
Rated Voltage (V) Rated Frequency (Hz)		Refer to the rating label put at the panel back.		

