

使用與安裝 說明書

洗衣乾衣機
(家用)

型號 NA-S106FR1

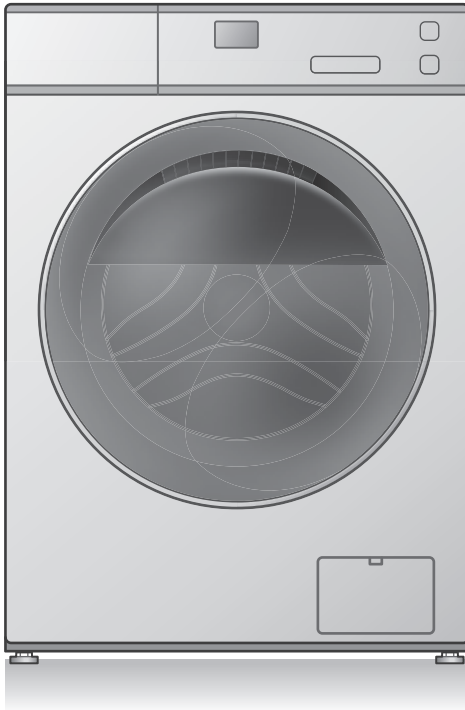

請務必閱讀這些說明。

HK

感謝您購買本產品。

- 為達到最佳的效能和安全性，使用前請詳細閱讀相關指示。
- 請妥善保存本手冊，以供日後參考之用。

目錄

安全注意事項	2
了解您的本機	7
洗衣前	8
控制面板	10
洗衣劑	12
洗衣乾衣	14
程序列表	16
程序詳情	18
洗衣乾衣小貼士	20
更改程序設定	22
更改本機設定	28
保養	29
為求效果更佳	33
疑難排解	34
錯誤顯示	40
選擇正確的位置	42
搬運及安裝	43
連接水管	45
試運行	47
規格	48

裝
安



安全注意事項



警告

可能導致嚴重受傷或死亡

兒童不得單獨使用。



- 肢體、感覺或精神殘障的人士，以及缺乏經驗與相關知識的人士（包括小孩），必須在負責其安全的人士監管指導下，方可使用本機。
- 請善盡監管之責，避免兒童將本機作嬉戲之用。

設置「Child Lock（兒童安全鎖）」。（第28頁）



開啟

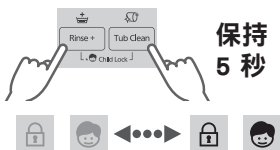

保持
5 秒



可能導致火災或觸電

請勿以濕手觸摸。



請勿握住或拉扯電線。

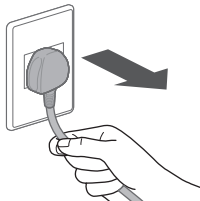

請勿使用。



插座轉換器

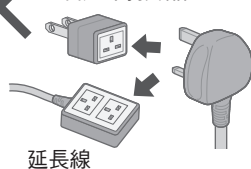

延長線

完全插入。

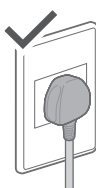
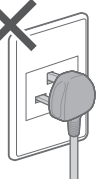

請勿使用。

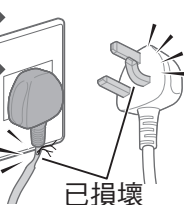

已損壞

- 如果電線損壞，必須由製造商或其服務代理商，或其他合資格人士更換，以免發生危險。

如果電線出現故障或損壞，請停止使用並諮詢電工技師。

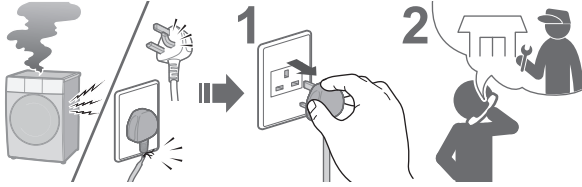

牢固地插入接地插腳。
請電氣技術人員提供新插座。

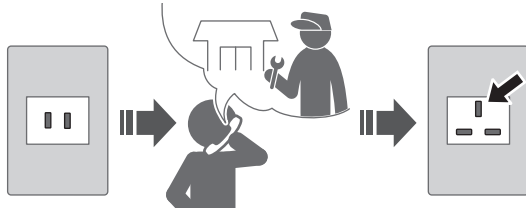

使用適合本機的插座。

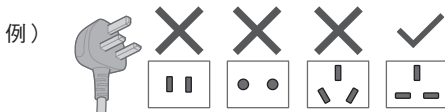

● 插頭形狀、插座形狀和額定值要求視乎地區而異。

積塵可能導致起火。

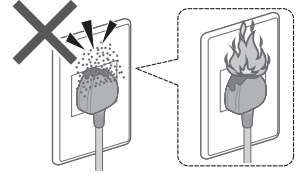

定期擦拭電源插頭。



遠離易燃物品。

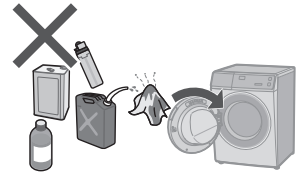

可能導致故障

請勿自行拆卸、修理或改裝。



安全注意事項 (續)



可能會導致起火 (為安全使用乾衣機)

請勿烘乾沾有易燃物的物品。



- 沾有食用油、丙酮、酒精、汽油、煤油、除汗劑、松節油、蠟、除蠟劑和化妝品油等物質的物品，即使經過清洗也不能放在本機中乾燥。

清空所有口袋。

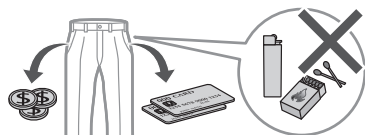

- 確保無任何物品遺忘在任何口袋中。特別要注意打火機和火柴，其可能會導致起火。

請勿烘乾橡膠等製成的物品。

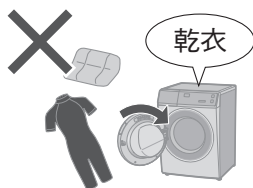

- 諸如泡沫橡膠（乳膠泡沫）、浴帽、防水紡織品、密封面料、橡膠背襯物品以及裝有泡沫橡膠墊的衣服或枕頭等物品不應放在本機中乾燥。此類材質可能被破壞，進而損壞本機。
- 請勿在本機中乾燥未清洗之物品。

不得將棉絨堆積在本機周圍。



請遵循以下事項。

- 切勿在乾燥週期結束前停止本機，除非迅速將所有物品取出並攤開以便散熱。
- 如果已使用工業化學品進行清潔，則不得使用本機。
- 不得通過定時器等外部開關設備為本機供電，或將本機連接至由基礎設施定期開關的電路。

! 注意

可能會導致漏水

關閉水龍頭。



使用新的水管套件。

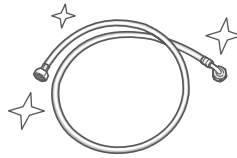

- 請使用隨附的新水管，不應使用舊水管。

可能導致受傷

小心勿夾到手指。

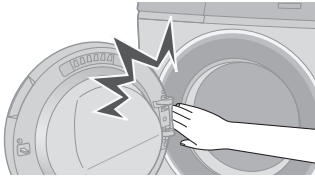

請勿在本機上攀爬。

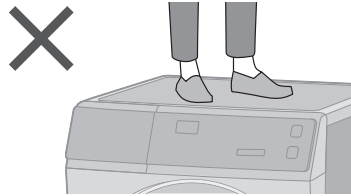

溫度尚高時請勿觸碰。

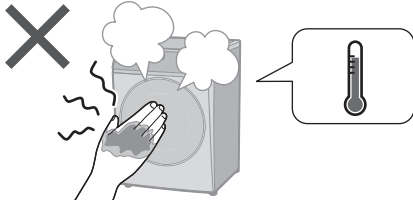

正確安裝本機。

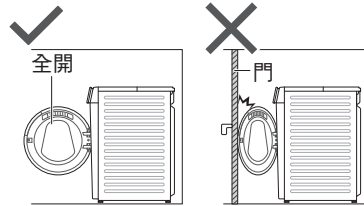

- 不得將本機安裝於可鎖定的門、推拉門或與本機相對的鉸鍊門後，此種方式會使本機門無法完全打開。

■ 關於乾衣物最大重量和水龍頭水壓，請參見 第48頁。

安全注意事項 (續)



注意

可能導致故障

遠離熱源和陽光直射。

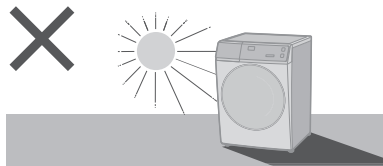

操作前請卸下運輸螺栓。

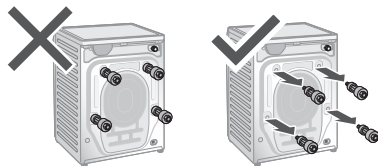

請勿堵塞。

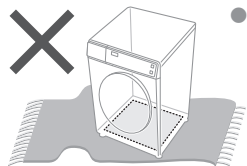

- 請勿在底座開口下放置地氈等遮擋物。

請勿使用熱水。

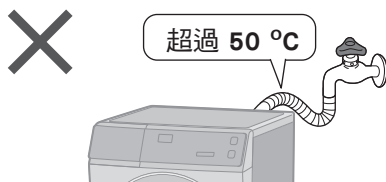

僅適用於可機洗物品。

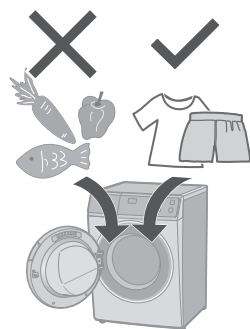

- 本機設計為家用。
本機不適用於以下應用：
 - 商店、辦公室和其他工作環境中的員工廚房區域；
 - 農舍；
 - 供給酒店、汽車旅館和其他住宅類型環境中的客戶使用；
 - 住宿加次日早餐型環境；
 - 公寓樓或自助洗衣店中的公共區域。

請勿清洗過於油膩的衣服。



遵照說明操作。



- 柔順劑或類似產品應遵照柔順劑說明之規定使用。

了解您的本機

部件名稱

洗衣劑格 (第12頁)

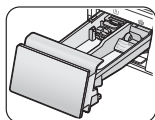

控制面板
(第10頁)

機門

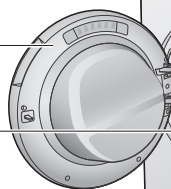

滾筒

門鉸

機門膠圈

可調地腳
(第44頁)

排水過濾器蓋
(第32頁)

排水管
(第45頁、46頁)

入水口 (第46頁)

運輸螺栓
(第44頁)

電線及插頭*
*插頭形狀視乎地區而異。

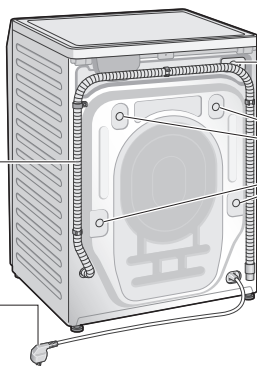

配件

□ 水管架 (1) (第46頁)



□ 罩蓋 (4) (第44頁)



□ 供水管 (1) (第45頁、46頁)

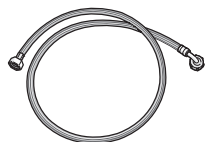

□ 底蓋 (1) / 螺絲 (1) (第43頁)

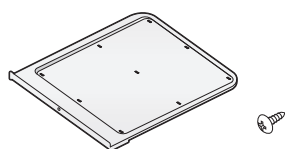

洗衣前

準備洗衣

將衣服放入滾筒之前

- 取下異物。

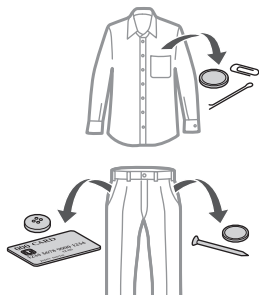

- 纖細衣物和小件物品請使用洗衣網。

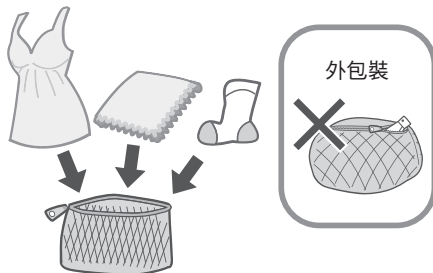

洗衣前檢查

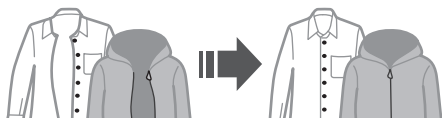

- 分開洗。

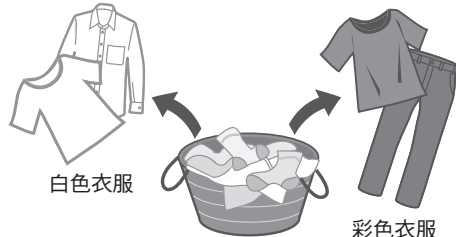

容易起球的衣服

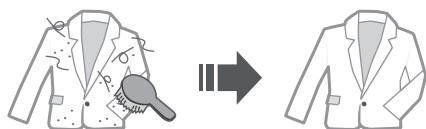

- 對重污漬進行預處理。



- 遵照洗衣標籤說明。



註

- 建議使用「Stain Master+ (去污專家+)」程序(第16頁、17頁)去除污漬。

忌水洗或乾洗

忌水洗或乾洗



皮革 / 毛皮



絲綢、人造絲和銅氨纖維（混紡面料）

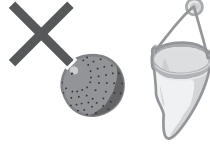

市售洗滌劑輔助工具

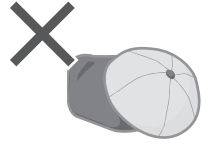

帶硬芯材料的帽子



靠墊、枕頭等

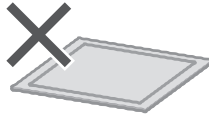

聚氨酯 / 橡膠背襯或厚墊



紙尿布

其他 ...

- 起皺和壓花製品
- 絨織物
- 可變形衣物（上衣、領帶、連衣裙等）
- 天鵝絨

忌乾洗

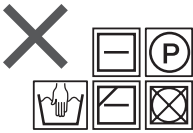

以上任何標記



毛織衣物



緊身衣或連褲襪

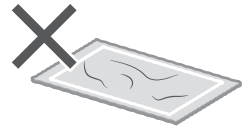

墊子和其他沾有寵物毛髮的物品

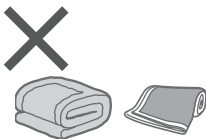

被子

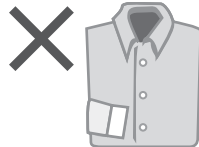

上漿衣物



花邊或刺繡服裝、新型合成纖維服裝等。

註

- 可能導致衣物變形、損壞及本機損壞或發生故障。

控制面板

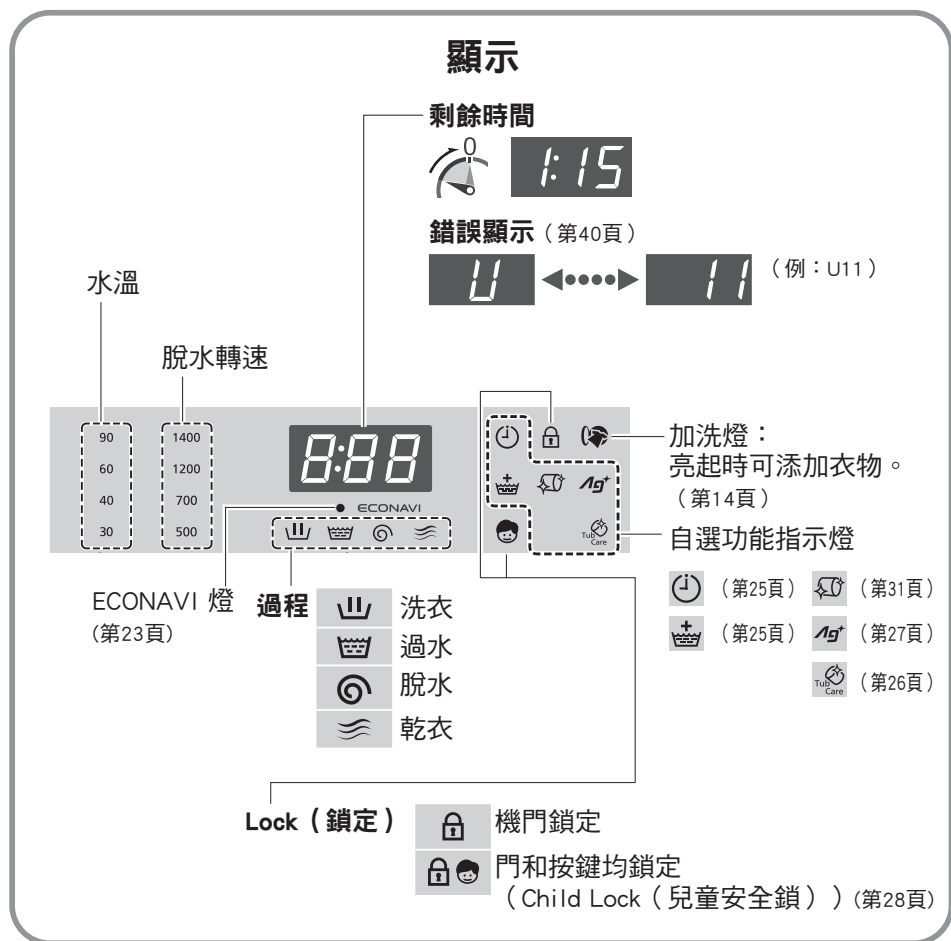

控制按鈕

電源按鈕

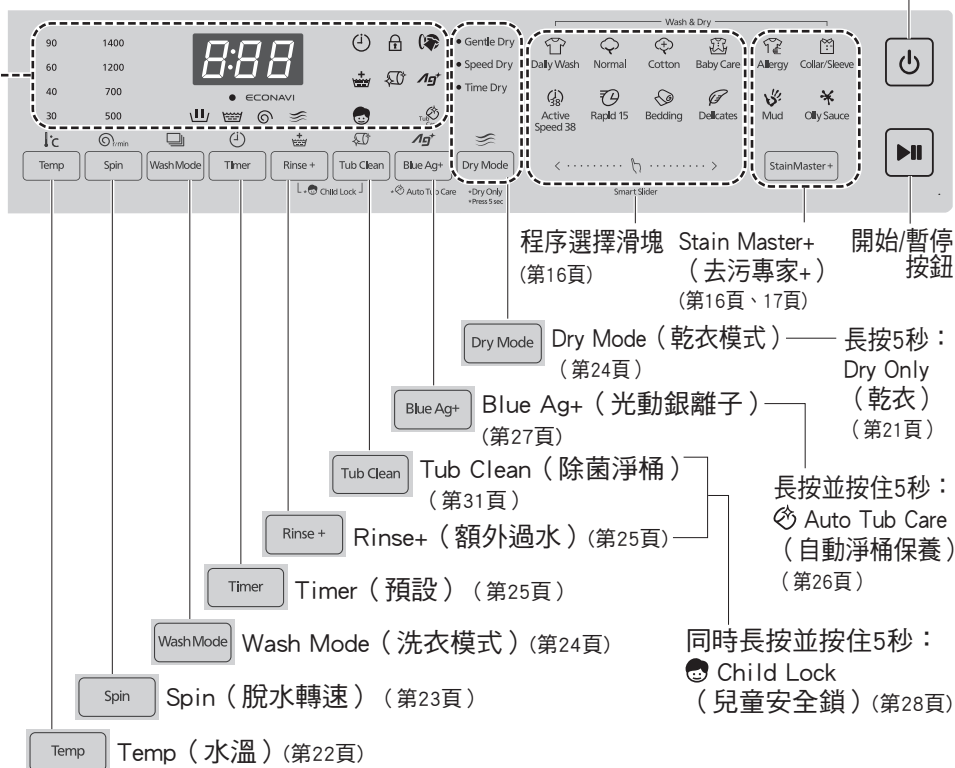

觸控操作

- 如果沾上水、洗衣劑或柔順劑，請立即關閉並用毛巾等擦拭。(故障原因)



註

- 關閉 ⇨ 重新打開



- 無操作 ⇨ 自動關閉



- 斷電時

⇨ 重新接通電源時，從停止之處重新執行。(自動重啟)

洗衣劑

- 遵循各包裝上的說明。

洗衣劑

使用低泡洗衣劑。

- 為防止洗衣劑殘留在洗衣劑格中：

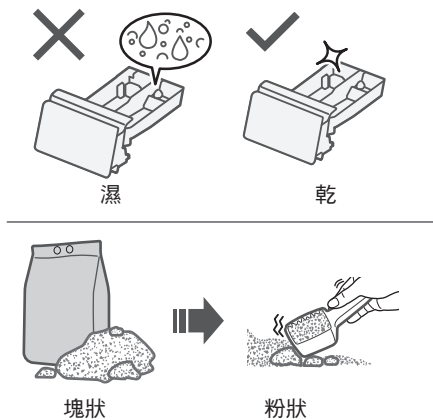

洗衣劑

粉狀洗衣劑

液體洗衣劑



柔順劑

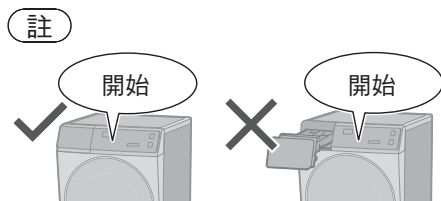
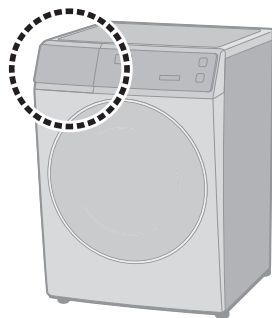
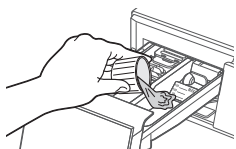

Ag+ (銀離子) 盒

(第27頁、31頁)

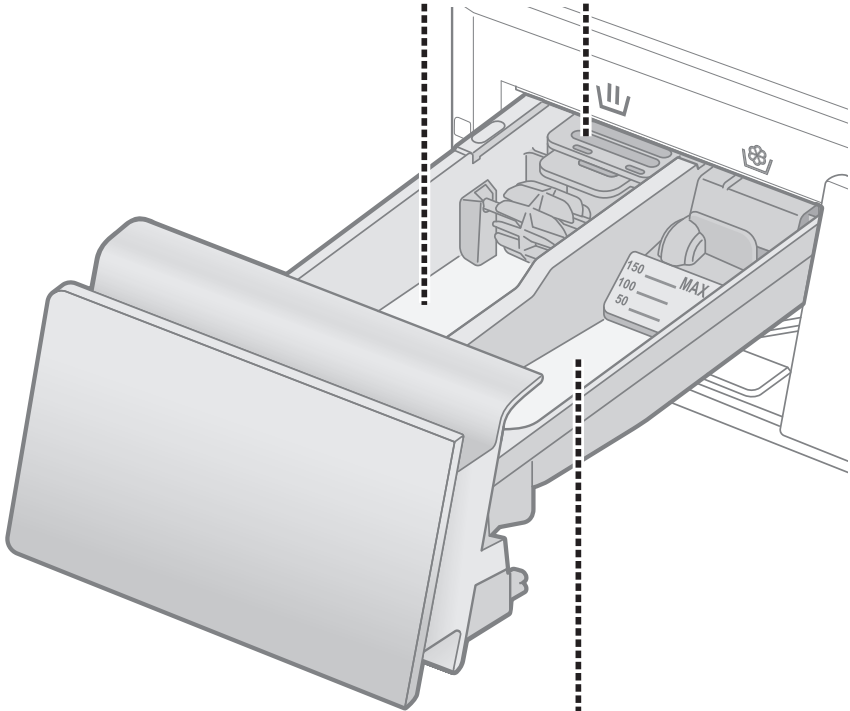

柔順劑



最多150 ml

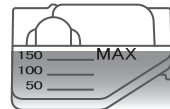
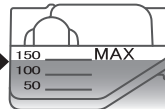

洗衣乾衣

基本方法

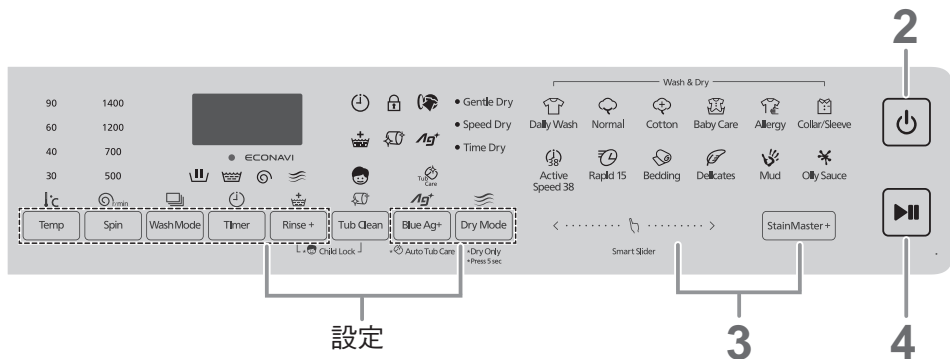

註

■ 勿讓衣物卡在機門。



■ 請勿將滾筒中的衣物塞得過滿。

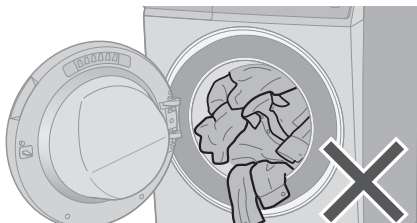

■ 若要在執行過程中打開機門

● 洗衣過程中

(可在 亮起時添加衣物。)

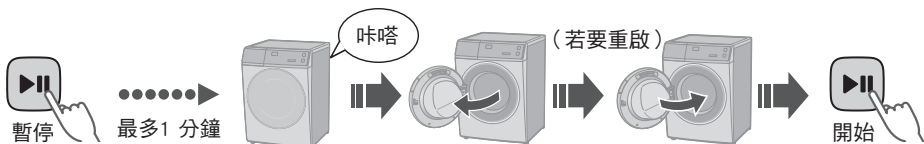

● 乾衣過程中



註

● 機門不打開 \Rightarrow (第35頁)



1

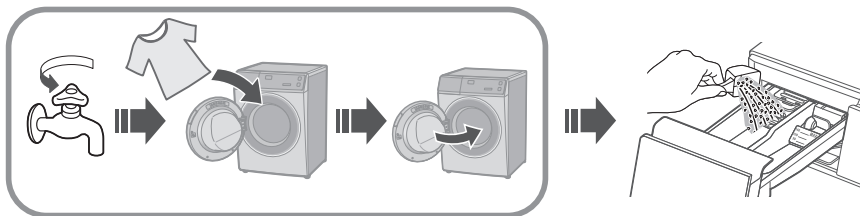

2



開啟

3

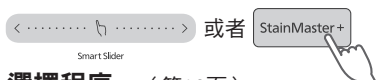

選擇程序。(第16頁)

■ 更改設定。

設定

Temp	Spin	Wash Mode	Timer
Temp (水溫) (第22頁)	Spin (脫水轉速) (第23頁)	Wash Mode (洗衣模式) (第24頁)	Timer (預設) (第25頁)
Rinse +	Blue Ag+	Dry Mode	
Rinse+ (額外過水) (第25頁)	Blue Ag+ (光動銀離子) ; Auto Tub Care (自動淨桶保養) (第26頁、27頁)	Dry Mode (乾衣模式) (第24頁)	

4



開始



測量衣物量

(30 秒)



顯示所需時間 (重新計算)

(例)

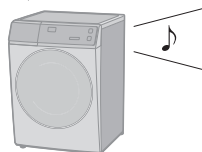

5

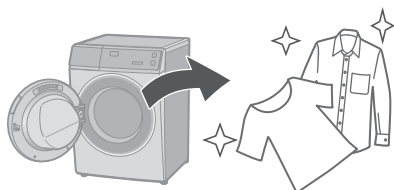

程序列表

WASH & DRY (洗衣乾衣) / WASH (洗衣)

程序	說明	洗衣量上限 (kg)		總時間	
		洗衣	乾衣	洗衣	洗衣乾衣
 Daily Wash (日常衣物)	<ul style="list-style-type: none"> ● 日常衣物 (較「Normal (一般)」 程序更快) 	10.0	6.0	1:30	4:53 - 7:25
 Normal (一般)	<ul style="list-style-type: none"> ● 日常衣物 	10.0	6.0	2:54	6:10 - 8:50
 Cotton (棉質)	<ul style="list-style-type: none"> ● 加時輕柔洗滌 	10.0	6.0	3:00	6:18 - 8:18
 Baby Care (嬰孩衣物)	<ul style="list-style-type: none"> ● 嬰孩及敏感皮膚的衣物 徹底沖洗 	5.0		2:20	5:45 - 7:35
 Tub Clean (除菌淨桶)	<ul style="list-style-type: none"> ● 清潔滾筒。 	無		3:45	4:25
<div style="border: 1px solid black; padding: 2px; display: inline-block;">StainMaster+</div> (去污專家+)	適用於以下污漬				
 Allergy (防敏感)	<ul style="list-style-type: none"> ● 適用於蟬蟲和花粉 	10.0	6.0	3:15	5:53 - 9:13
 Collar/ Sleeve (衣領袖口)		10.0	6.0	3:10	6:35 - 8:30

WASH (洗衣)

程序	說明	洗衣量上限 (kg)	總時間
 Active Speed 38 (快速洗衣38)	<ul style="list-style-type: none"> ● 較小負載 	5.0	0:38
 Rapid 15 (速洗15)	<ul style="list-style-type: none"> ● 較小負載且輕微污漬 	2.0	0:15
 Bedding (寢具)	<ul style="list-style-type: none"> ● 大件物品 	3.0	1:30
 Delicates (纖細衣物)	<ul style="list-style-type: none"> ● 輕柔洗衣 	2.0	0:50
StainMaster + (去污專家+)	適用於以下污漬		
 Mud (泥漬)		10.0	3:30
 Oily Sauce (油性醬汁)		10.0	3:00

DRY (乾衣)

程序	說明	洗衣量上限 (kg)	總時間
Dry Only (乾衣)  保持5秒	<ul style="list-style-type: none"> ● 用於乾燥衣物。 	6.0	1:54 - 6:00

- 總時間為估算值 (當標準供水量為15 升/分)。
適用於各程序的預設水溫。

程序詳情

程序		設定	自動設定			Temp (水溫) (°C)
			Temp (水溫) (°C)	Spin (脫水轉速) (轉/分)	Dry (乾衣)	
WASH & DRY (洗衣乾衣)	 Daily Wash (日常衣物)	40	1200	Gentle	冷水、30、40、60	
	 Normal (一般)	40	1200	Gentle	冷水、30、40、60	
	 Cotton (棉質)	60	1400	Gentle	冷水、30、40、60	
	 Baby Care (嬰孩衣物)	40	1400	Gentle	冷水、30、40、60	
	 Allergy (防敏感)	90	1200	Gentle	60、90	
	 Collar/Sleeve (衣領袖口)	40	1200	Gentle	40	
	 Tub Clean (除菌淨桶)	40	1200	Speed	40	
WASH (洗衣)	 Daily Wash (日常衣物)	40	1200	-	冷水、30、40、60	
	 Normal (一般)	40	1200	-	冷水、30、40、60	
	 Cotton (棉質)	60	1400	-	冷水、30、40、60	
	 Baby Care (嬰孩衣物)	40	1400	-	冷水、30、40、60	
	 Allergy (防敏感)	90	1200	-	60、90	
	 Collar/Sleeve (衣領袖口)	40	1200	-	40	
	 Tub Clean (除菌淨桶)	40	1200	-	40	
	 Active Speed 38 (快速洗衣38)	40	1200	-	冷水、30、40	
	 Rapid 15 (速洗15)	冷水	1200	-	冷水	
	 Bedding (寢具)	冷水	700	-	冷水、30	
	 Delicates (纖細衣物)	30	500	-	冷水、30、40	
	 Mud (泥漬)	40	1200	-	40	
	 Oily Sauce (油性醬汁)	40	1200	-	40	
DRY (乾衣)	Dry Only (乾衣)	-	√*1	Gentle	-	

註

- 對於額定容量的正常髒衣物，我們建議使用「Cotton (棉質)、60 ° C，1400 轉/分」，其根據 IEC 60456 進行能源和水效率方面的測試。
- 實際水溫可能異於聲明的循環溫度。
- 這些結果取決於水壓、水硬度、入水口溫度、室溫、洗衣類型和數量、污漬程度、使用的洗衣劑、主電源的波動和選擇的附加功能。

設定範疇		自選功能					
Spin (脫水轉速) (轉/分)	Dry Mode (乾衣模式)	Wash Mode (洗衣模式)	Dry Mode (乾衣模式)	Timer (預設)	Rinse+ (額外過水)	Blue Ag+ (光動銀離子)	Auto Tub Care (自動淨桶保養)
1200、1400	Gentle、Speed、Time	✓	✓	✓	✓	✓	✓
1200、1400	Gentle、Speed、Time	✓	✓	✓	✓	✓	✓
1200、1400	Gentle、Speed、Time	✓	✓	✓	✓	✓	✓
1200、1400	Gentle、Speed、Time	✓	✓	✓	✓	✓	✓
1200	Gentle、Speed、Time	-	✓	✓	✓	-	✓
1200、1400	Gentle、Speed、Time	✓	✓	✓	✓	✓	✓
1200	Speed	-	✓	-	-	-	-
☒、500、700、1200、1400	-	✓	-	✓	✓	✓	✓
☒、500、700、1200、1400	-	✓	-	✓	✓	✓	✓
☒、500、700、1200、1400	-	✓	-	✓	✓	✓	✓
☒、500、700、1200、1400	-	✓	-	✓	✓	✓	✓
☒、500、700、1200	-	-	-	✓	✓	-	✓
☒、500、700、1200、1400	-	✓	-	✓	✓	✓	✓
1200	-	-	-	-	-	-	-
☒、500、700、1200、1400	-	✓	-	✓	-	✓	✓
☒、500、700、1200	-	-	-	✓	-	-	-
☒、500、70	-	✓	-	✓	✓	✓	-
☒、500	-	✓	-	-	✓	✓	-
☒、500、700、1200、1400	-	✓	-	✓	✓	✓	✓
☒、500、700、1200、1400	-	✓	-	✓	✓	✓	✓
-	Gentle、Speed、Time	-	✓	-	-	-	-

☒：僅排水（不脫水）

● 為「Time Dry（自選時間乾衣）」設定時間：30、60、90、120、180、210分

*1 處於「Gentle Dry（輕柔乾衣）」或「Speed Dry（快速乾衣）」模式中時，

如衣物很重，則執行脫水轉速：1200

如衣物很輕，則不執行脫水：☒

洗衣乾衣小貼士

Bedding (寢具)

■ 可水洗物品

- (洗衣)
- (手洗)
- 100 %棉質或100 %合成纖維

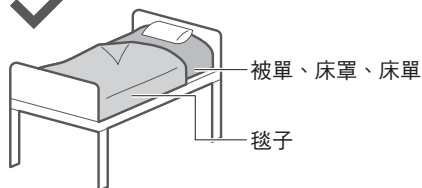

■ 不可水洗物品



電熱毯



註

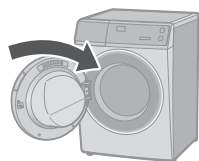

■ 將毯子放入滾筒

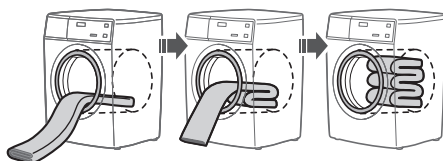
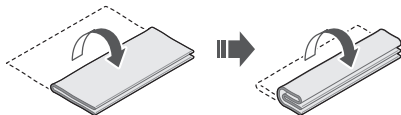

註

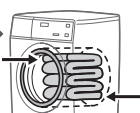

Delicates (纖細衣物)

■ 洗衣時

- 若要充分漂洗，請使用「Rinse+ (額外過水)」功能。(第25頁)

註



漂白劑



用於纖細衣物的
液體洗衣劑



■ 執行結束後

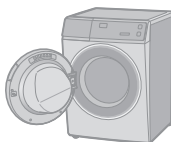

即刻取出







Dry Only (乾衣)

您可視乎衣物更改乾衣模式。

- 1  開啟
- 2  ● Gentle Dry
保持5秒(適用於「Dry Only(乾衣)」)
- 3 選擇「Dry Mode(乾衣模式)」。

- 4  開始

Dry Mode (乾衣模式)	說明
Gentle Dry (輕柔乾衣)	適用於高溫敏感的衣服 (最多6.0 kg)。 
Speed Dry (快速乾衣)	適用於不易起皺的衣物 (最多6.0 kg)。 
Time Dry (自選時間乾衣)	<ul style="list-style-type: none"> • 適用於易起皺的衣物。  更薄的平織和縐織等。 • 適用於少量衣物 (最多0.5 kg)。 *時間：30分鐘 *乾衣後：  即刻取出 • 適用於半乾衣物。 *時間：30分鐘及以上

註



- 即使在乾衣，也請打開水龍頭。
- 在乾衣時機門鎖定。



更改程序設定

■ 準備

- 將衣物分類，並放入滾筒內。
(第8頁)
- 倒入洗衣劑。(第12頁)



2 選擇程序。(第16頁)

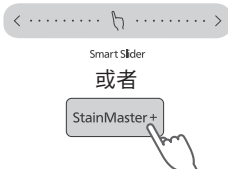

3 更改程序設定。



Spin Spin (脫水轉速)

Temp Temp (水溫)

- 可用選項和設置範圍視乎程序而異。(第18頁)
- 若選擇不可用選項，則會聽到提示聲。



Temp (水溫)

更改洗衣水溫。



■ 設定說明

低	高
● 彩色 	● 白色 
● 稍有污漬 	● 嚴重污漬 
● 易於縮水	● 棉質

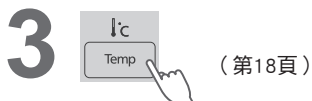

Spin (脫水轉速)

更改脫水轉速。

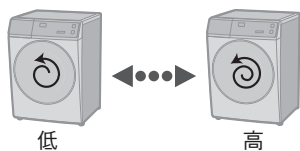

■ 設定說明



3

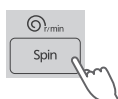

(第19頁)

■ 欲在洗衣時更改設定

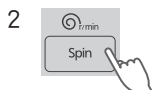

ECONAVI

- 「Normal (一般)」及「Daily Wash (日常衣物)」程序

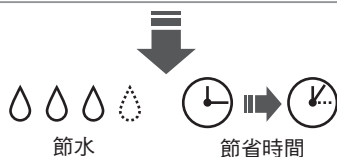

■ 燈光提示



更改程序設定 (續)

■ 準備

- 將衣物分類，並放入滾筒內。
(第8頁)
- 倒入洗衣劑。(第12頁)



2 選擇程序。 (第16頁)

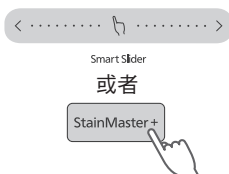

3 更改程序設定。



Wash Mode
(洗衣模式)

WashMode

Timer (預設)

Timer

Rinse+ (額外過水)

Rinse +

Dry Mode (乾衣模式)

Dry Mode

- 可用選項和設置範圍視乎程序而異。(第18頁)
- 若選擇不可用選項，則會聽到提示聲。



Wash Mode (洗衣模式)

選擇洗衣、過水及脫水的組合。

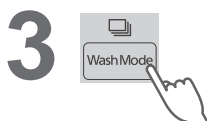

 *1	洗衣
 *2	過水
 *2	脫水
 	洗衣及過水
 	洗衣及脫水
  *2	過水及脫水

*1 在洗衣流程後排水。

*2 如滾筒中有水，則先排水。

WASH & DRY (洗衣乾衣)

≡ Dry Mode (乾衣模式)

選擇流程組合。

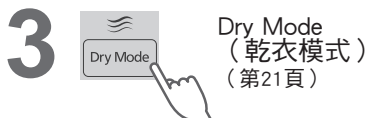

⌚ Timer (預設)

設置多少個小時後完成執行。
(最多 24 小時)



■ 若要檢查預設時間

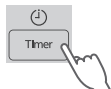

■ 若要取消設定

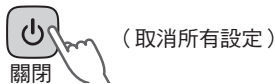

註

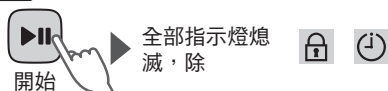

● 不適用：第19頁

👑 Rinse+ (額外過水)

添加額外過水。

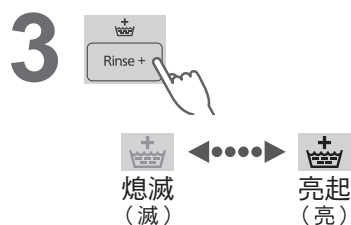

■ 欲在洗衣時更改設定



更改程序設定 (續)

■ 準備

- 將衣物分類，並放入滾筒內。
(第8頁)
- 倒入洗衣劑。(第12頁)



2 選擇程序。(第16頁)

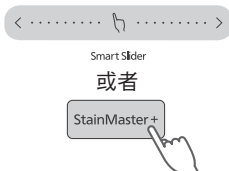

3 更改程序設定。



Blue Ag+ (光動銀離子)
Auto Tub Care
(自動淨桶保養)

- 可用選項和設置範圍視乎程序而異。(第18頁)
- 若選擇不可用選項，則會聽到提示聲。



Auto Tub Care (自動淨桶保養)

添加除菌淨桶流程。

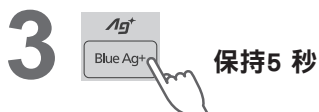

註

- 設置已記憶。

Ag⁺ Blue Ag⁺ (光動銀離子)

除菌功能 (最多3.0 kg)。



3

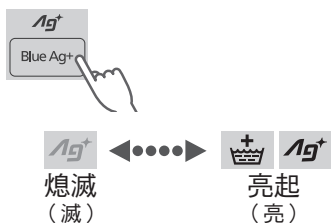

註

- 請勿將水用於其他目的。



- 衣物的種類、洗衣劑、柔軟劑和水的硬度可能會影響結果。
- 如發生發癢等情況，請停止使用。



■ Ag⁺ (銀離子) 盒的使用壽命

- 「Blue Ag⁺ (光動銀離子)」可使用300至350次 (如每週使用一次，可使用約7年)。
- 內容物減少時更換該盒。

● 放回原位
⇒ (第31頁)

● 洗衣不添加「Ag⁺ (銀離子)」



更改本機設定

設置 Child Lock (兒童安全鎖)

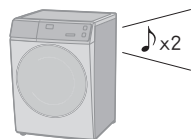
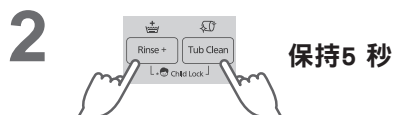
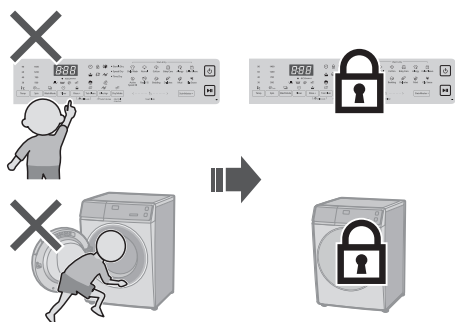

亮起
(亮)

■ 若要取消：

相同步驟  x4



熄滅
(滅)

取消蜂鳴

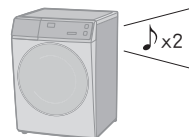

■ 若要重置：

相同步驟  x4

保養

供水過濾器

如水流不暢

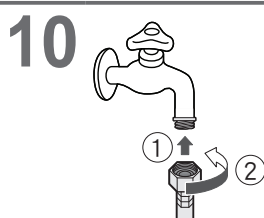
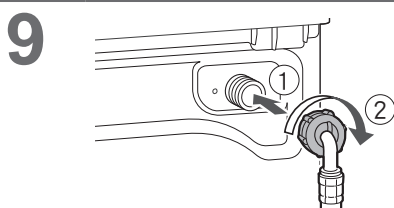
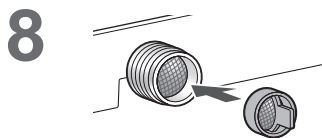
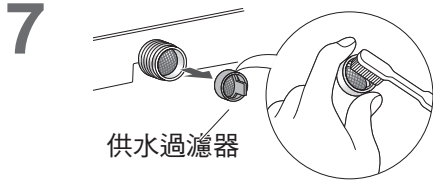
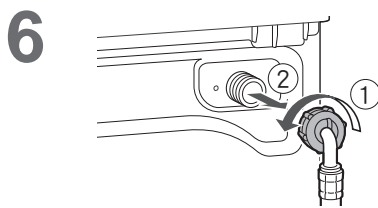
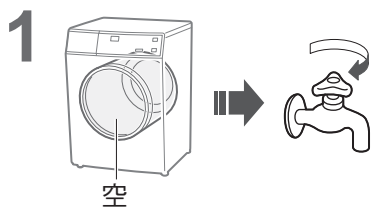
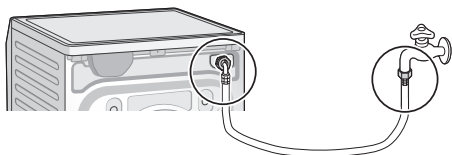

保養 (續)

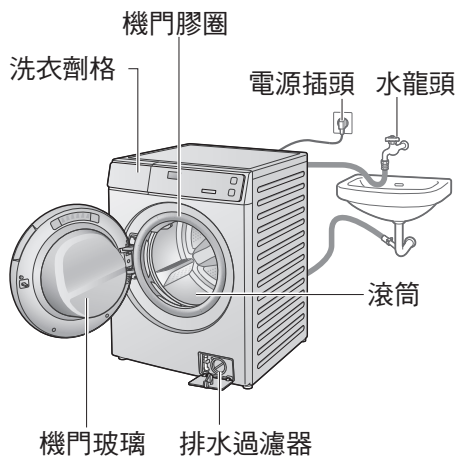

本機



機門膠圈



對於重度污漬

溫和的廚房清
洗劑

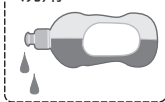

註

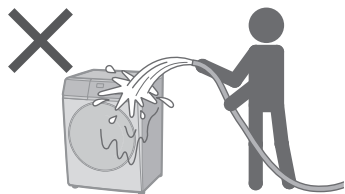

- 請勿使用含砂礫的清潔劑或稀釋劑，或含酒精或石蠟油之產品。

洗衣劑格

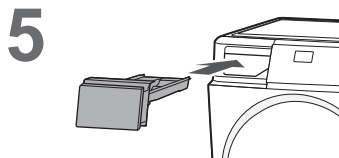
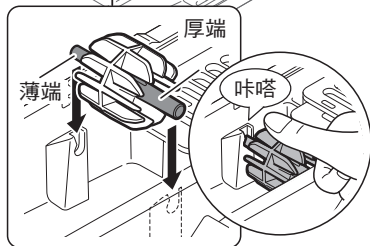
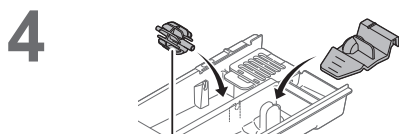
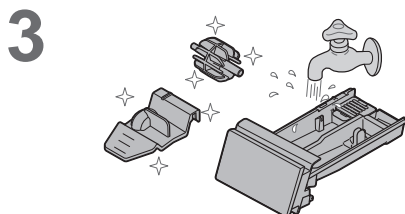
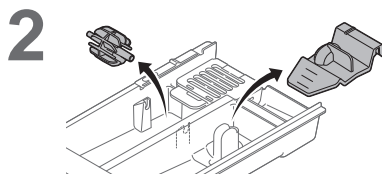
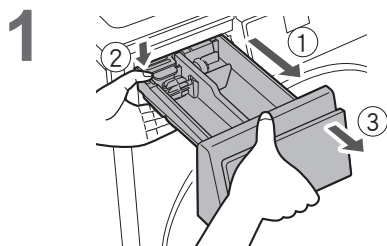

如內容物減少

■ 更換Ag+ (銀離子) 盒

1

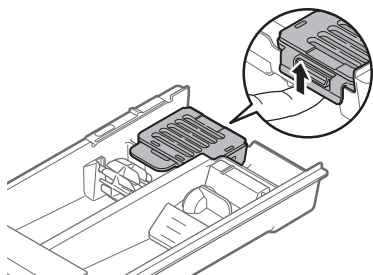

2

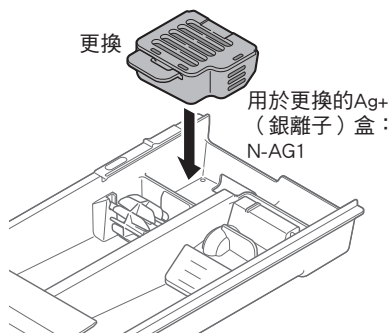

註

- 不可打開Ag+ (銀離子) 盒。

滾筒

每月一次或者如果 閃爍 <Tub Clean (除菌淨桶)>

1



2

增白漂白劑 (氯漂白劑)

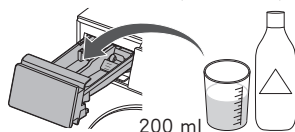

3

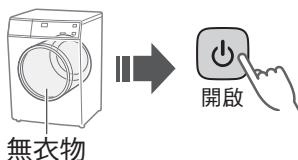

4

- 適用於Wash (洗衣)



- 適用於Wash & Dry (洗衣及乾衣)



5



註

- 如若未執行「Tub Clean (除菌淨桶)」程序，則當其他程序運行3次時， 指示燈熄滅。

保養 (續)

排水過濾器

每月一次

進行此步驟之前，務必排空滾筒的水。

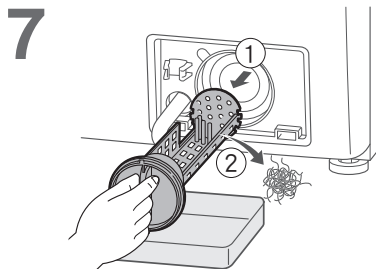
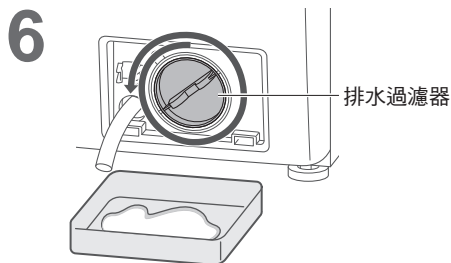
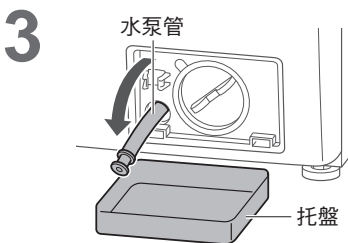
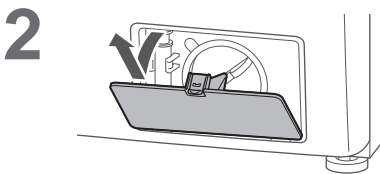
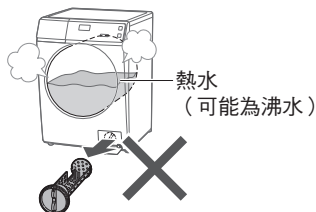

! 注意



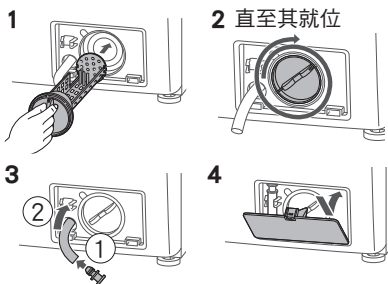

8 放回原位











為求效果更佳

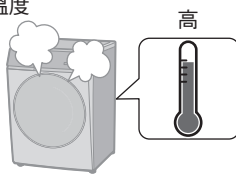





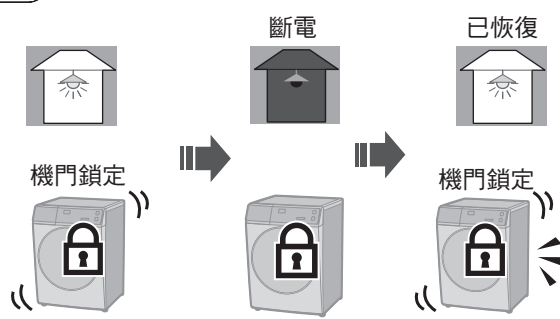



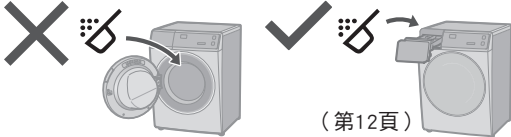

表現	獲得良好效果之小貼士
<p>衣物縮水</p> 	<p>若為乾衣造成之棉質產品縮水</p> <ul style="list-style-type: none"> ● 潤濕後拉伸。 
<p>因起皺而引起手感改變</p> 	<ul style="list-style-type: none"> ● 減少衣物量。  <ul style="list-style-type: none"> ● 選擇乾衣模式。(第21頁)  <p>視乎衣物而定</p> <ul style="list-style-type: none"> ● 乾衣後  <p>即刻取出</p>
<ul style="list-style-type: none"> ● 乾衣不充分 ● 乾衣程度不均 	<ul style="list-style-type: none"> ● 減少衣物量。  <ul style="list-style-type: none"> ● 打開。 
<p>觸感粗糙</p> 	<ul style="list-style-type: none"> ● 毛巾清洗後觸感粗糙時  <p>柔順劑</p> <p>若依然感覺粗糙</p>  <p>乾衣</p>
<p>附有棉絨</p> 	<ul style="list-style-type: none"> ● 「Rinse+ (額外過水)」或「Tub Clean (除菌淨桶)」  <p>或者</p> <p>(第25頁) (第31頁)</p>



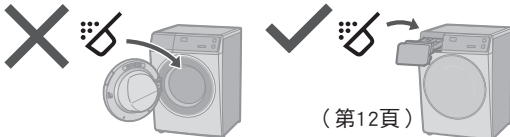
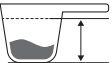

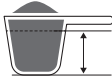

疑難排解

	表現	待檢查點
	<p>觸摸按鈕</p>  <p>無反應</p>	<p>□ 可能之原因</p> <ul style="list-style-type: none"> ● 執行期間  <p>□ 嘗試</p> <ul style="list-style-type: none"> ● Child Lock (兒童安全鎖) (第28頁) 
<p>主機</p> <p>未執行</p> 	<p>□ 檢查</p> <ul style="list-style-type: none"> ● 斷電 ● Timer (預設)  <p>□ 嘗試</p> <ul style="list-style-type: none"> ● 關上機門。 ● 打開。 ● 拔掉插頭再插入。  <ul style="list-style-type: none"> ● 按「開始」。 ● 打開斷路器。 	
<p>橡膠味</p> 	<p>□ 可能之原因</p>  <p>□ 嘗試</p> <ul style="list-style-type: none"> ● Tub Clean (除菌淨桶) (第31頁) 	



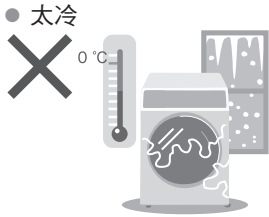
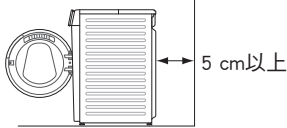

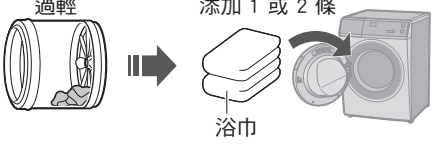
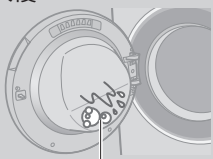
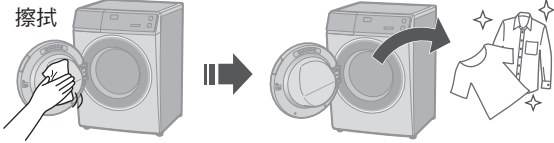

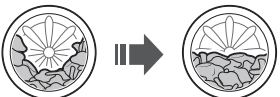
表現	待檢查點
<p>主機</p> <p>機門不打開</p> 	<p>□可能之原因</p> <ul style="list-style-type: none"> ● 在執行過程中 (洗衣或乾衣)  <p>機門鎖定。 若要在執行過程中打開機門 (第14頁)</p> <p>□檢查</p> <ul style="list-style-type: none"> ● 溫度  ● 水位  <p>□嘗試</p> <ul style="list-style-type: none"> ● Child Lock (兒童安全鎖) (第28頁)  ● 執行期間 <ol style="list-style-type: none"> 1 關閉  2 開啟  3 Wash Mode (第24頁)  4 打開  <p>註</p> 



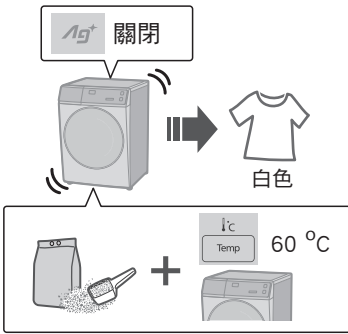





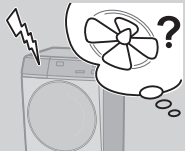

疑難排解 (續)

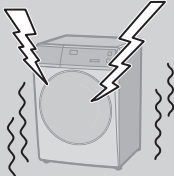
	表現	待檢查點
	<p>洗衣後</p> 	<p>□ 檢查</p>  <p>(第12頁)</p>
	 <p>泡沫</p>	<p>□ 可能之原因</p> <ul style="list-style-type: none"> ● 泡沫量不盡相同。 <ul style="list-style-type: none"> ● 溫度  ● 水位  ● 水質 
洗衣劑和泡沫	<p>不夠</p> 	<p>□ 檢查</p> <ul style="list-style-type: none"> ● 粉狀洗衣劑  <p>(第12頁)</p> <ul style="list-style-type: none"> ● 洗衣劑太少  ● 低泡洗衣劑  ● 嚴重污漬  ● 負載過大 
	<p>過多</p> 	<p>□ 檢查</p> <ul style="list-style-type: none"> ● 洗衣劑過多 
洗衣	<p>洗衣期間</p>  <p>排水</p>	<p>□ 可能之原因</p>  <p>泡沫過多 泡沫檢測功能 自動排水 自動供水</p>





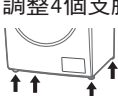
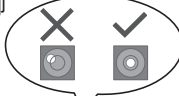

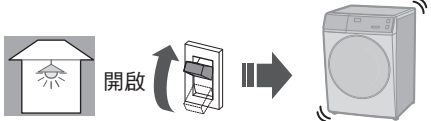





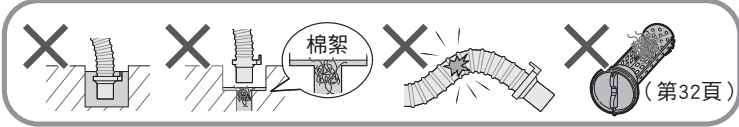

	表現	待檢查點
乾衣	<p>乾衣耗時過久</p> 	<p>□ 檢查</p> <ul style="list-style-type: none"> ● 太重  ● 太冷  <p>□ 嘗試</p> <ul style="list-style-type: none"> ● 檢查位置。 
過水 / 脫水	<p>在脫水期間</p>  <p>停止 → 旋轉數次</p>	<p>□ 可能之原因</p> <p>不均 → 自動更正 → 停止 → 自動更正 → 均勻</p>  <p>□ 嘗試</p> <p>過輕 → 添加 1 或 2 條浴巾</p> 
過水 / 脫水	<p>洗衣後</p>  <p>泡沫或水</p>	<p>□ 嘗試</p> <p>擦拭</p> 
過水 / 脫水	<p>脫水更改為過水</p>  <p>脫水 → 過水</p>	<p>□ 可能之原因</p> <ul style="list-style-type: none"> ● 如若衣物不均，則本機會自動以過水程序更正不均現象。 

疑難排解 (續)

	表現	待檢查點
衣物	<p>如衣物發黃</p> 	<p>□ 嘗試</p> 
時間	<p>洗衣期間 顯示時間</p> 	<p>□ 可能之原因</p> <ul style="list-style-type: none"> ● 在執行期間校正剩餘時間。  <ul style="list-style-type: none"> ● 若設定更改 ● 若衣物不均  <p>⇒ 剩餘時間可能會增加。</p>
	<p>剩餘時間 不減少</p>  <p>或者</p> <p>突然減少</p> 	<p>□ 可能之原因</p> <p>顯示時間僅供參考。</p>
噪音		<p>□ 可能之原因</p> <ul style="list-style-type: none"> ● 此為正常現象。 排水泵正在工作。

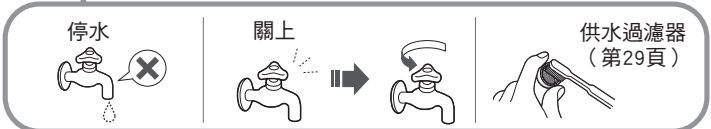

	待檢查點
<p>風扇轉動聲</p> 	<p>□ 可能之原因</p> <ul style="list-style-type: none"> ● 此為正常現象。 風扇冷卻電氣部件。
<p>馬達發出聲音</p> 	<p>□ 可能之原因</p> <ul style="list-style-type: none"> ● 此為正常現象。 滾筒接合時，馬達發出短暫聲音。
<p>異常噪音 (或振動)</p> 	<p>□ 檢查</p> <ul style="list-style-type: none"> ● 金屬物品 <ul style="list-style-type: none"> ✗  ● 運輸螺栓 (第44頁) <ul style="list-style-type: none"> ✗  ✓  ● 斜坡或不穩定的表面 <ul style="list-style-type: none"> ✗  ✗  ✓  ● 調整4個支腳 <ul style="list-style-type: none"> ✗  ✓  <p>(第44頁)</p>
<p>其他</p> <p>斷電</p>  <p>斷路器</p> <p>關閉</p> 	<p>□ 檢查</p> <ul style="list-style-type: none"> ● 重新接通電源時，從停止之處重新執行。 

錯誤顯示

錯誤顯示	待檢查點
<p>U 11</p> <p>無法排水</p>	<p>1 檢查 </p> <p>2 </p> <p>3  開始</p>  <p>(第32頁)</p>
<p>U 12</p> <p>機門打開</p>	<p>1 </p> <p>2  開始</p>
<p>U 13</p> <p>無法脫水</p>	<p>1 </p> <p>2 檢查</p> <p>3   開始</p>  <p>不均 平均 不穩定或傾斜 穩定 過多 減少 太少 增加</p>
<p>U 14</p> <p>無法供水</p>	<p>1 檢查</p> <p>2 </p> <p>3  開始</p>  <p>停水 關上 供水過濾器 (第29頁)</p>
<p>U 15</p> <p>乾衣期間無法排水</p>	<p>1  關閉</p> <p>2 檢查排水管 (參考U11)</p> <p>3  開啟</p> <p>4 再次選擇乾衣程序  開始</p>

錯誤顯示	待檢查點
------	------

U 17
無法脫水

1 重啟

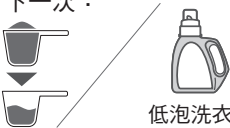
2 運行「Rapid 15 (速洗15)」

● 下一次：

 低泡洗衣劑

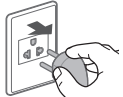
H 00

1 

2 

3 

■ 資訊

hot
無法打開

熱

 乾衣過程中 (第14頁)

Temp

 保持5 秒

開始冷卻

 5至25分鐘



選擇正確的位置



請聯絡服務人員安裝。

- 請勿自行安裝本機。
- 遵循此安裝方法。否則的話，若出現任何事故或損壞，Panasonic 不承擔責任。

本機尺寸

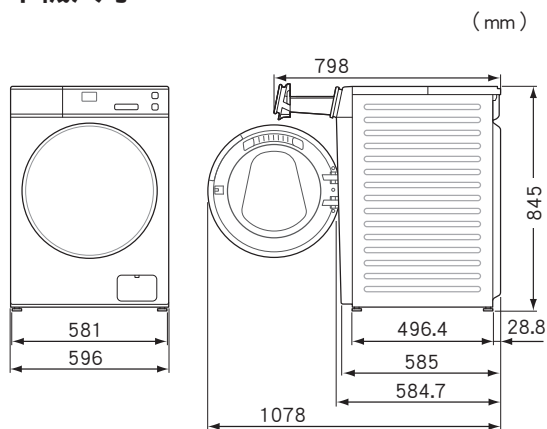

■ 內嵌安裝

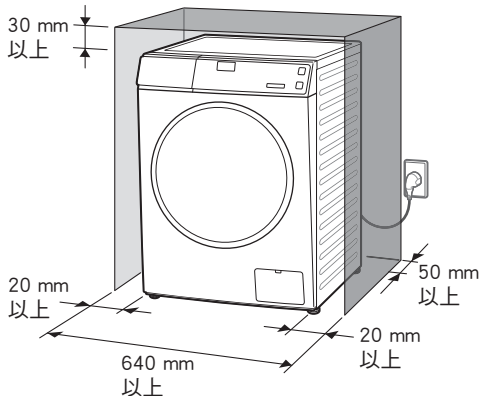

- 請勿讓設備的金屬部分接觸金屬水槽或其他設備。

檢查位置。

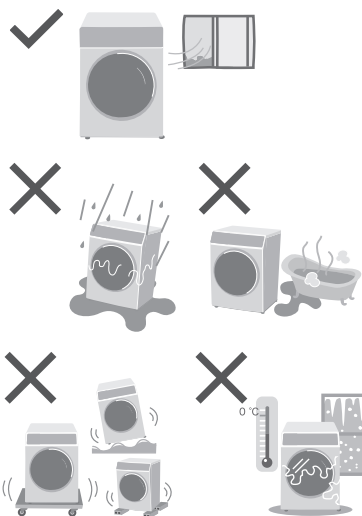

小心

可能導致功能異常。



請勿將本機安裝在 IH 電飯鍋等產生電磁波的設備附近。

搬運及安裝

搬運本機

切換單獨進行。

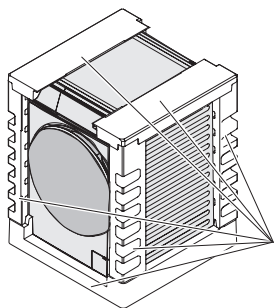
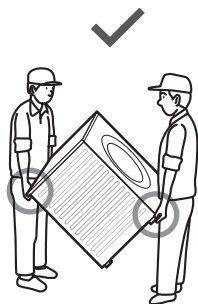

開始使用本機之前，
請取下所有包裝墊。

安裝底蓋

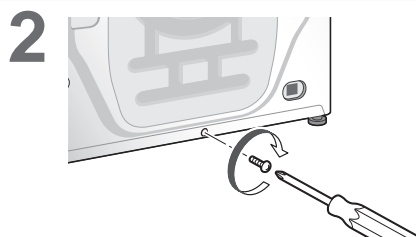
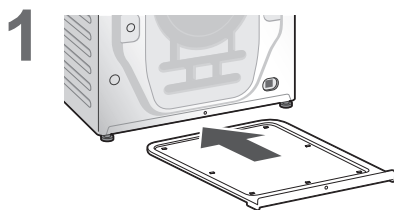

搬運及安裝 (續)

卸下運輸螺栓

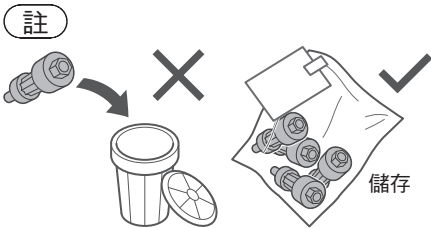
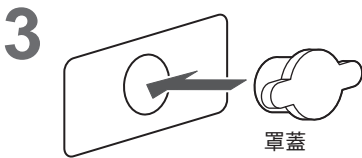
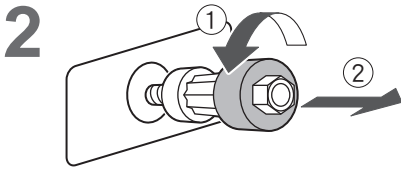
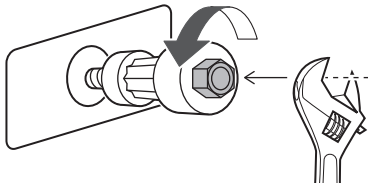
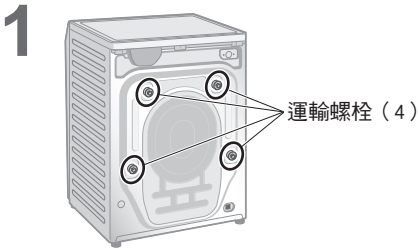

■ 再次移動本機

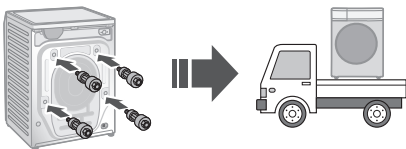

調整本機水平度

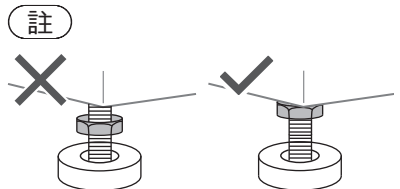
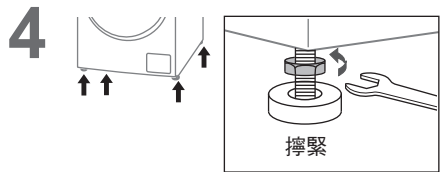
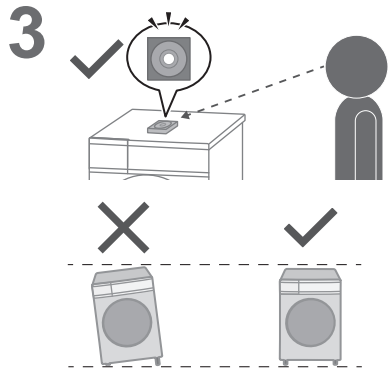
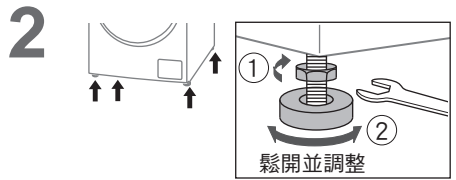
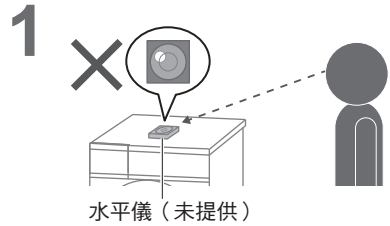

連接水管

請正確連接水管以免漏水。

水管及電線的最長連接距離

右側連接

(cm)

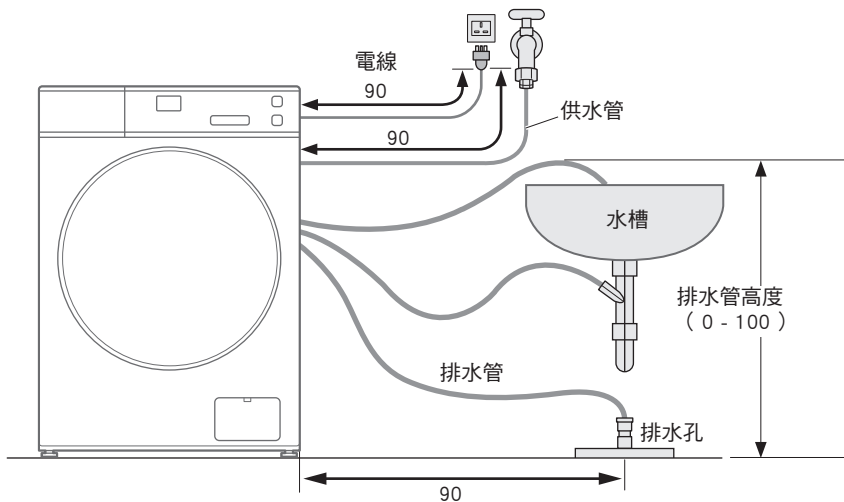

左側連接

(cm)

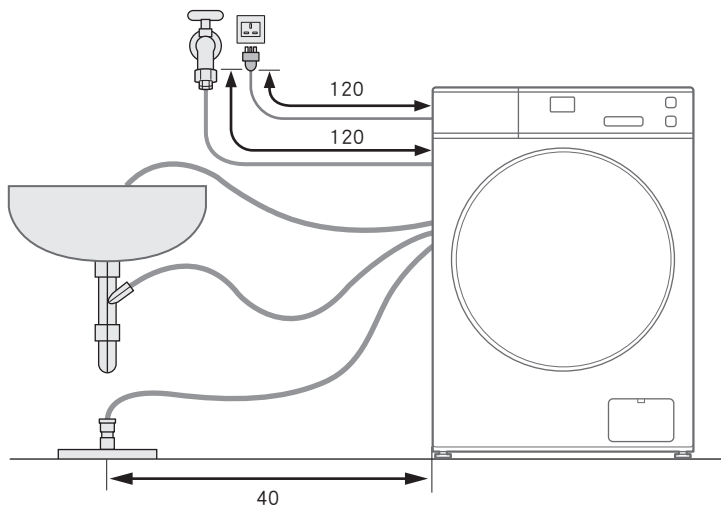

連接水管 (續)

供水管

■ 連接供水管

⚠ 注意

- 請鎖緊螺帽。
- 請勿扭動、擠壓、改裝或剪短水管。

1

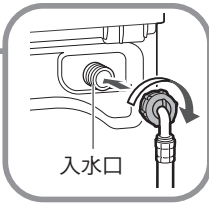
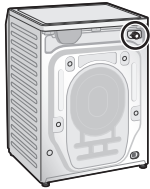

2

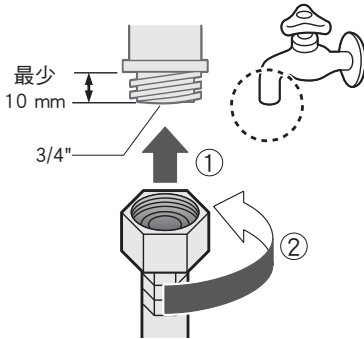

3

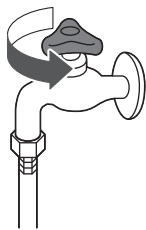

排水管

■ 排水至水槽或洗手盆

小心

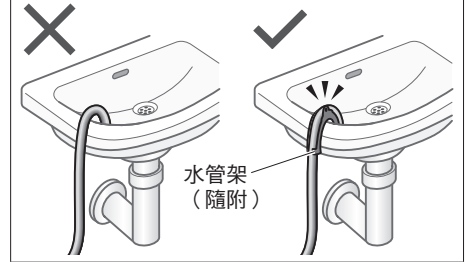

■ 排放到立管

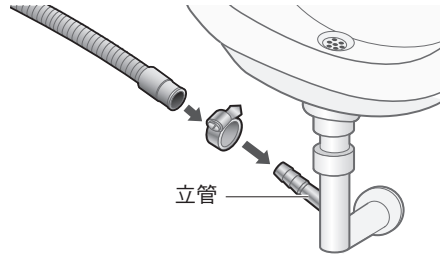

■ 排水至排水孔

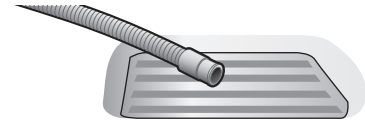

註

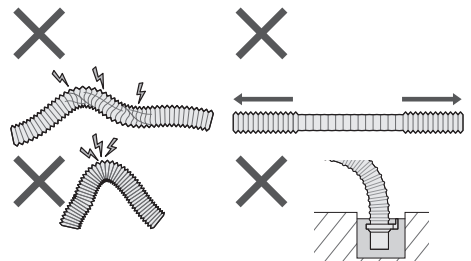

試運行

1



2

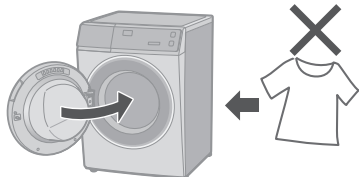

3



開啟

4

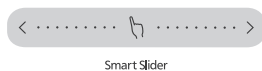

Smart Slider

Rapid 15 (速洗15)

5



開始

試運行後檢查

問題

原因和措施

漏水



正確連接供水管

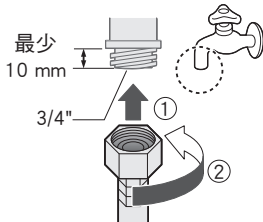

聲音異常



聲音異常

● 卸下運輸螺栓
(第44頁)

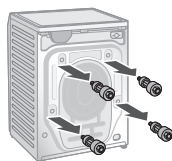

● 穩定安裝

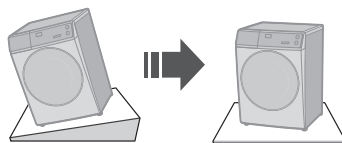

錯誤顯示



參見第40頁。

規格

		NA-S106FR1
額定電壓 (V)		220 - 240
額定頻率 (Hz)		50
最大能量額定輸入功率 (W)		1600 - 1900
熱能額定輸入功率 (W)	用於洗衣	1445 - 1710
	用於乾衣	905 - 1090
最高脫水轉速 (轉/分)		1400
產品尺寸 (闊 x 深 x 高) (mm)		596 × 585 × 845
產品重量 (kg)		70
乾衣物最大重量 (洗衣) (kg)		10.0
乾衣物最大重量 (乾衣) (kg)		6.0
水龍頭水壓 (MPa)		0.01 - 1.0