

Panasonic®

Operating Instructions 使用說明書

Electric Thermo Pot **For Household Use**

電子保溫熱水瓶 **家用型**

Model No. / 型號 **NC-SU403P**



Thank you for purchasing this Panasonic product.

- Please read this Operating Instructions carefully in order to use this product correctly and safely.
- Before using this product, **please give your special attention to the Safety Precautions.**
- Please keep this Operating Instructions for future use.
- Panasonic will not accept any liability if the appliance is subject to improper use, or failure to comply with these instructions.

感謝購買本樂聲牌產品。

- 請細閱本操作說明書，以正確及安全地使用本產品。
- 使用本產品前，請特別注意安全措施。
- 請保留本操作說明書作日後使用。
- 若不正确使用器具或未有遵照說明書指示，樂聲牌將概不負責。

①

Table of Contents

Main Features.....	4
Safety Precautions	5
Part Names and Handling Instructions.....	8
Preparation before use	9
How to use.....	10
Convenient use methods.....	12
Care & Cleaning	14
• How to clean the inner container using citric acid.....	15
Troubleshooting.....	16
Replacement of Parts.....	17
Specifications	Back cover

目錄

主要特點	18
安全注意事項	19
各部分名稱和操作方法	22
使用前的準備工作	23
使用方法	24
方便的使用方法	26
保養和清洗	28
• 當附著水垢時，請用檸檬酸清洗	29
故障排除	30
更換易耗品	31
規格	封底

Main Features

Taste enhancement

Boiling with diamond fluorine and BINCHO charcoal.

- Particle of diamond and ground BINCHO charcoal are mixed with fluorine and used for inner container. Color, taste and aroma of tea can be maintained.

Ceramic filter

(refer to P.9 for fixing)

- Approx. 90% of chlorine, fungus odor and trihalomethane are cut.
(Consumable part, refer to P.17)

Healthy course of tea serving

(How to use, refer to P.13)

- Boiled water is alkalified, and promote extraction of tea component such as catechin.

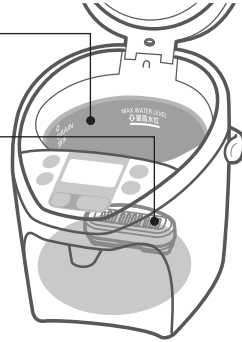

Convenience

Hot water is dispensed in 4 levels

(How to use, refer to P.11)

- Volume of hot water dispensed varies depending on degree of pressing and dispensing time.

Cordless dispensing of hot water

(How to use, refer to P.11)

- Hot water can be dispensed even when cord is removed.

Spotlight

- Safety and accuracy ensured with spotlight to indicate position of pouring water.



Economy use

4 Timer selections

4 / 6 / 8 / 10 hours Timer can be selected.

(See "Setting the timer" on P.13)

Energy saving

Heater is controlled to suit with purpose of use. Power is saved automatically by boiling while dispensing water and cutting the heater while water is not dispensed.

3 Keep-warm temperature selections

98 / 90 / 80 keep-warm temperature can be selected.

(See "Keep-warm function" on P.13)

VIP Keep-warm

The heat insulator keeps hot water temperature, and thus it will save electricity.

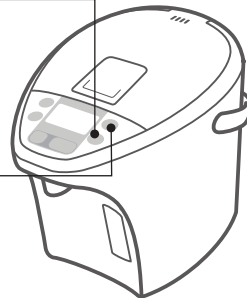

Safety Precautions

Please take these precautions strictly

For safety sake and in order to prevent property damage and the hazards to users and others, please read the following instructions strictly.

- The signals indicate harm and damage when the product is used wrongly.



WARNING

Indicating "it may cause severe injuries and death".



CAUTION

Indicating "the user may get injured or the product may cause property damage".

- The symbols indicate specified items that must be followed.



This symbol indicates prohibition.



This symbol indicates mandatory.



WARNING

To Prevent Burns



- **This appliance is not intended for use by persons (including children) with reduced physical, sensory or mental capabilities, or lack of experience and knowledge, unless they have been given supervision or instruction concerning use of the appliance by a person responsible for their safety. Children should be supervised to ensure that they do not play with the appliance.**

- **Do not let the unit fall over. Do not lift, tilt or shake the unit or carry it by the lid.** Even when the dispenser key is locked, hot water may leak through the dispensing spout and the steam vent, causing burns if the unit falls over or is tilted.

- **Do not pour in water above the maximum water level indication line. If the appliance is overfilled, boiling water may be ejected.**

Hot water can spill causing burns.

- **Do not close the lid by force.**

Hot water can spill causing burns.

- **Do not boil anything other than water.**

Do not heat tea bags, tea leaves, milk, alcohol or anything other than water which may cause it to spurt out hot liquid or steam and cause burns.

The water tube may also get clogged, the inner container may burn or corrode, and the fluororesin insulating coating may peel off.

- **Do not block the steam vent.**

Hot water can overflow causing burns.

- **Do not throw away the remaining hot water while the lid is attached.**

If the lid comes off, hot water may splash causing burns.

- **Do not touch the steam vent.**

This may cause burns. Take special care to prevent infants from touching the steam vent.



- **Close the lid securely.**

If the unit topples, hot water may spill out causing burns.

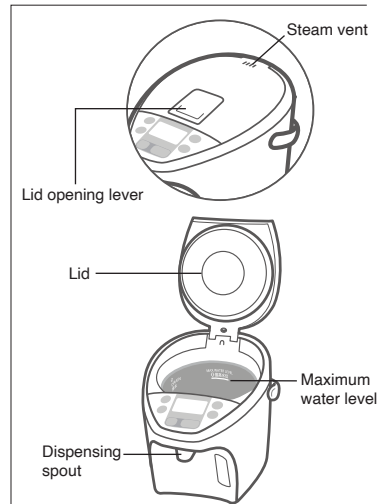

Safety Precautions

Please take these precautions strictly



WARNING

Power Cord



- **Never do anything that might cause damage to the cord, power plug or body plug.**

Do not damage them, modify them, place hot objects near to them, bend them, twist them, stretch them, place heavy objects on them, or bundle them together.
If the unit is used when damaged, electrical short circuit or fire may result.

➔ If the supply cord is damaged, it must be replaced by the manufacturer, its service centre or similarly qualified persons in order to avoid a hazard.

- **Do not connect or disconnect the power plug or the body plug with wet hands.**

This may result in electric shock.

- **Do not allow infants access to the body plug.**

You must pay special attention to prevent infants from putting the body plug into their mouths.

This may result in electric shock or injury.

- **Do not place small metal parts near the body plug.**

This may result in electric shock, electrical short circuit or fire.



- **Make sure the power plug is correctly inserted into the wall outlet.**

If the plug is inserted improperly it may cause electric shock or generate heat resulting in fire.

➔ Do not use a damaged plug or a connection in a loose outlet.

- **Dust off the power plug or the body plug regularly.**

A build-up of dust on the plug will attract humidity, which could cause cable damage and the deterioration of insulation resulting in fire.

➔ Remove the plugs and clean them with a dry cloth.

- **Use a single outlet that matches the power rating of the unit.**

Plugging multiple appliances into one outlet may generate heat and result in fire.

Power cord

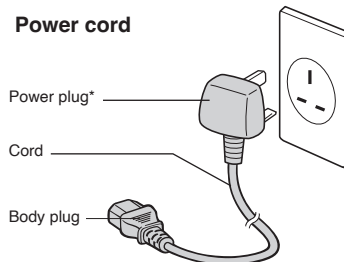

* The shape of the power plug may be different from illustration.

During use



- **Do not immerse the unit in water or splash water over it.**

● Do not supply water directly from the tap or place the unit in a sink where the bottom may get wet.

● Do not turn the unit upside down when the bottom is wet.

It may cause a short circuit and may result in electric shock, and also if water overflows from the pot and enters the electrical parts in the main unit, it may cause malfunction.

- **Never disassemble, repair or modify the unit.**

Any attempt to do so may cause the unit to operate abnormally and may result in fire or injury.

➔ If in need of repair (except for the replacement parts), please contact an authorized Service Center.

- **Do not use to store ice.**

Condensation will occur, creating a potential source of electric shock and malfunction.



CAUTION

To Prevent Burns



- **Do not place the unit on unstable surfaces.**
The appliance may topple over causing burns.
- **Do not open the lid or dispense hot water while boiling.**
Splashing hot water or steam may cause burns.
- **Do not rotate the unit while dispensing hot water.**
Splashing hot water may cause burns.
- **Position the handle so that steam is directed away from it.**
- **When opening or closing the lid, keep hands away from the steam.**
Steam can cause burns.
- **Do not touch the hot parts of the unit during use or shortly after use.**
This may cause burns.
- **When carrying the unit, do not touch the lid opening lever.**
The lid may open causing burns and other injury.



- **The heating element surface is subject to residual heat after use. Wait until the unit is cooled down before cleaning.**
A hot appliance may cause burns.
➔ When disposing hot water, be careful not to get burned.

Power Cord



- **Do not use a different cord and do not use this cord with any other device.**
(Do not use a power cord other than the one designed specifically for the unit.)
It may cause malfunction or fire.



- **When the unit is not in use, unplug the power plug from the wall outlet.**
Deteriorating insulation may result in electric shock and/or fire.
- **When unplugging the unit, pull by the power plug - not the cord.**
Electric shock and short circuit may result in fire.

During use



- **Fill the water higher than the minimum water level.**
- **Do not pour out water too swiftly.**
It may cause a malfunction if water splashes over lid release part or operation panel.
- **Do not leave water in the inner container.**
It may cause the container to corrode or smell.
- **Do not use the unit on surfaces that can be affected by heat for a long time.**
The unit may get discolored or break up.
- **Do not place near walls or furniture.**
Steam and heat could damage walls and furniture, causing a change in color and shape.



- **Replace gasket if it discolours whitish.**
Otherwise it may cause hot water to spill out when it is leaned or knocked down accidentally.
- **This product is intended for household use only.**
- **Ensure to clean the surfaces in contact with food after use.**
(See page 14-15 "Care & Cleaning".)

Part Names and Handling Instructions

Operation panel

If the protective film is still covering the surface of the operation panel, peel it off before using the operation panel.

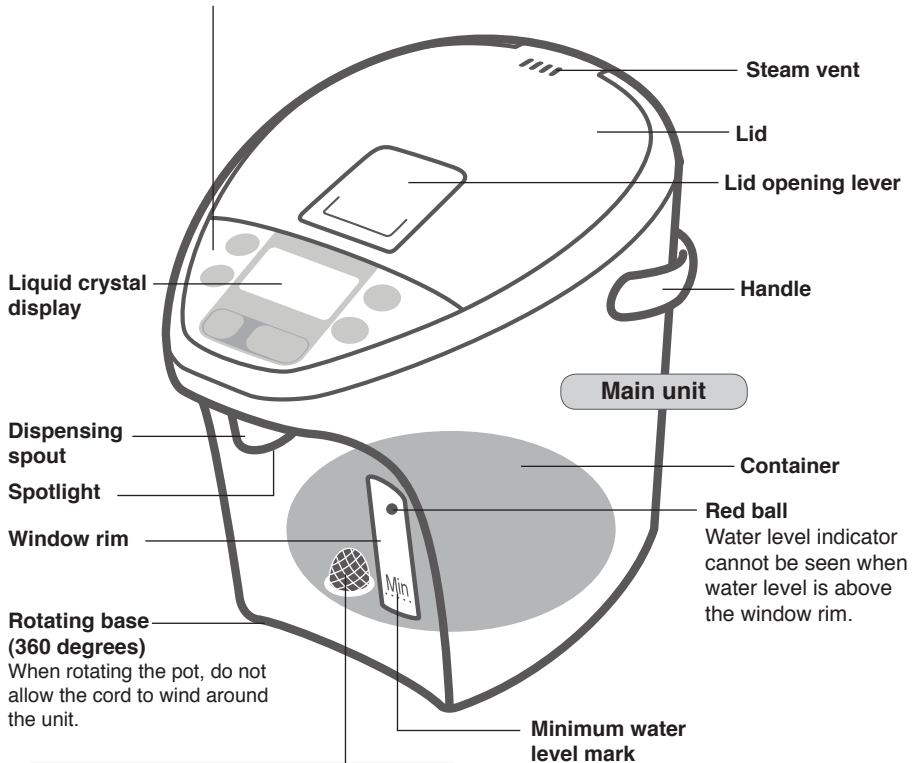

Mesh filter

(Replaceable part)

It may have come off from the bottom of the container. Push it completely into the correct position. (⇒P.17)

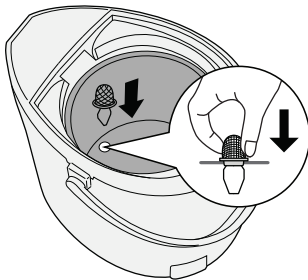

Power cord

Power plug*

Cord

Body plug

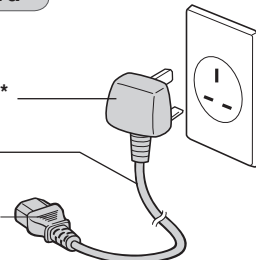

* The shape of the power plug may be different from illustration.

Preparation before use

Before you use this pot for the first time

Boil water in it to clean the thermo pot container and the sections through which the hot water is dispensed.

- 1 Boil some water.
- 2 Dispense the hot water.
- 3 Empty the container via "DRAIN" mark.

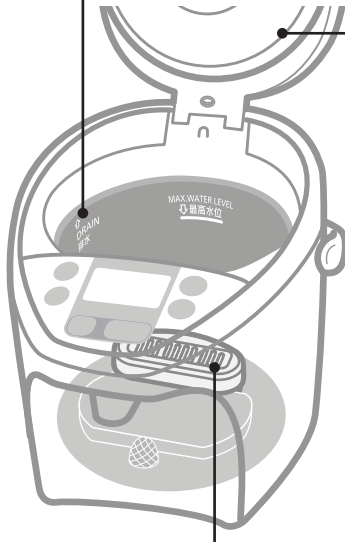

How to Remove the Lid

- 1 Press the lid opening lever, open the lid and lift up the knob.



- 2 Open the lid.

How to close : Push until "click" sound.

- 2 Pull it up slantwise.

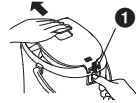

- 1 While pressing the lid lever,

How to set : Insert the lid slantwise.

How to set the ceramic filter

- 1 Shake in water.



- 2 Set it at the back.

Fix with magnet

Heater surface

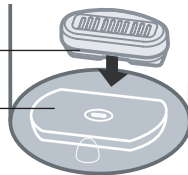

Handling

- Do not wash with detergent. (It causes remaining odor)
- Do not attach on heater surface. (It causes malfunction)
- Do not put it close to objects sensitive to magnetic force such as credit card.



Economical Use

Setting the Energy Saving and Timer
(⇒ P.12)

- Control the heater according to the habit of dispensing. Heater is on at the time interval when hot water is wanted. Otherwise it is off automatically to save the keep-warm power.

- Once start using, it will record the time interval when hot water is dispensed.
- After using for a week, it will automatically increase the keep-warm temperature according to the record of the week before.

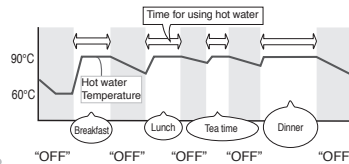

How to use

Boiling water

Pouring out

How to use



Boiling water

Pouring out

※ **Minimum water level**
Fill the water higher than the minimum water level.

※ **MAX. WATER LEVEL**
Do not fill water above maximum water level.

To reduce the chlorine in the water (Long Boil)

Press  key to make the indicator light flash.

(Press one time while water is being boiled, and press twice while water is being kept warm.)

Extends the boiling time by about 7 minutes to reduce the chlorine by about 90% in the water.

- Press  key again to boil.

After adding water

In case it does not start boiling automatically.

 Press the button and the light will be on.



Connect the power plug after filling the water and closing the lid. (① → ②)

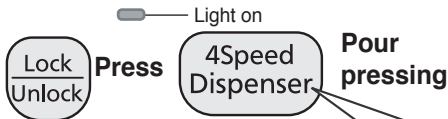
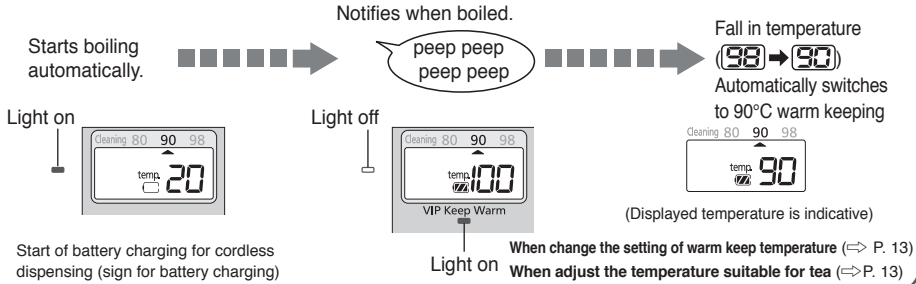

Automatically locked in 10 seconds after dispensing is finished.

When dispensing while cord is removed. (Cordless dispensing)

Guideline for dispensing volume

Battery charge volume	Dispensing volume
	Approx. 3L or more * 1
	1.5L or less

Water temperature falls to about 90°C in 1 hour after boiling at room temperature 20°C.

※ Temperature falls quicker if water volume is smaller.

Volume of water dispensed varies depending on degree of pressing and dispensing time.

	Dispensing period (Amount of time press continuously)		
	Less than 5 seconds	From 5 to 12 seconds	More than 12 seconds
Press slightly		LEVEL ▬	
Press strongly	LEVEL ▬▬	LEVEL ▬▬▬	LEVEL ▬▬▬▬

※ Be careful for rebound of hot water when press strongly

When cordless dispensing



※1 Full water volume may not be indicated if frequently dispensed.

- Indication light turns off and cannot dispense hot water after 8-10 hours even not dispensed.

When the unit is not in use

Unplug, and remove the lid. Pour out any remaining hot water slowly via the DRAIN mark.

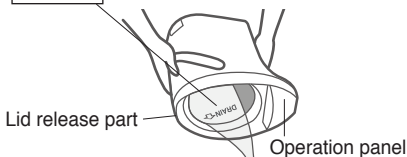

Requests

- Do not pour out water too swiftly. (It may cause a malfunction if water splashes) over lid release part or operation panel.
- Do not leave water in the container. (It may cause the container to corrode or smell.)

Convenient use methods

Timer

Energy Saving

Convenient use methods

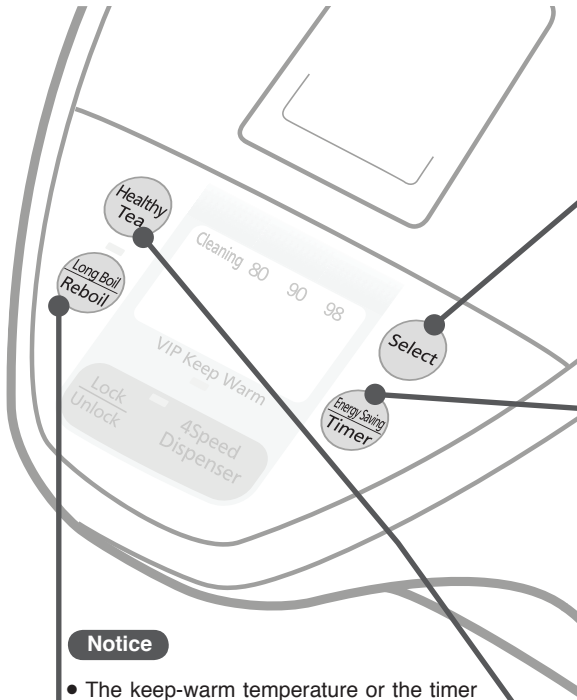

Notice

- The keep-warm temperature or the timer can be set while the water is being boiled or being kept warm.
- After power is restored in the event of a power and display failure, the keep-warm temperature will be automatically set to 90, even if the timer or the "98" or "80" keep-warm function was previously selected.

Keep-warm Function

- It is ideal to use 80°C to keep warm for making green tea.
- Energy can be saved if keep-warm temperature is lower.
- Approx. 80°C of water is the most suitable for natural leaf tea.

When the unit will not be used for a short time, such as when you go out for a day...

Setting the timer

- While setting the timer, the electrification of heater stops.

Setting the energy saving

- No boiling while not in use (water temperature of approx. 60°C is maintained as the lowest), and heated to preset temperature adjusting the time for use.
- This is recommended if dispense time is regularly fixed.

Make the water suitable for brewing tea.
(Healthy Tea)

Reboil

- It is ideal to use boiling water for making coffee / tea / instant cup noodles etc.

Time required for the reboil procedure

From 98 keep-warm : approx. 4.5 min.
From 90 keep-warm : approx. 6.5 min.
From 80 keep-warm : approx. 10.5 min.

(Amount of water: Maximum)
(Room temperature: 20°C)

Press the  key to reboil water that is being kept warm.



After a few minutes, water will be boiled.

- The keep-warm temperature setting is left unchanged.



Keep-warm Function

Reboil

Healthy Tea

Each time **Select** key is pressed, "▲" mark will shift to the next choice and change the keep-warm temperature.

Cleaning 80 90 98

Cleaning 80 90 98

90

Time required to reach the settled preset temperature

90 → 80 keep-warm : approx. 0.3 - 1.0 hour

98 → 90 keep-warm : approx. 0.7 - 2.0 hour

(Amount of water: Maximum
Room temperature: 20°C
Previous keep-warm setting: 90)

After a short time, water will be kept warm at approx. 80°C

When the water will be boiled 8 hours later

Each time **Energy Saving Timer** key is pressed the light will shift to the next choice.

4h → 6h → 8h → 10h

↑ Cancel ← Energy saving ↓

(Will return to the temperature indication)

Remaining time will be indicated on 1 hour base.

When cancel the timer, press **Energy Saving Timer** key again

8 hours later, timer will turn off and water starts boiling

When the water reaches the boiling temperature, keep-warm function starts at the settled temperature.

If set up "Energy saving"

Boiling started before dispensing time and kept at preset temperature.

"OFF" is displayed when not dispensed.

"OFF" lights off.

Caution

While Energy Saving is set, boiling starts automatically at dispensing time. Circuit breaker may be tripped if used together with other equipment in a same line.

Healthy Tea

Press

Notifies when boiled

(Setting of warm keep temperature does not vary.)

peep peep
peep peep

Light on

Blink

Light on

VIP Keep Warm

Notice

Setting is released when water is added while **Tea** lights on. (**Tea** lights off)

Setting will be released when **Energy Saving Timer**, **Long Boil Reboil** and **Healthy Tea** buttons are pressed while **Tea** blinks.

Time for boiling up

After filled water : approx. 41 min.

From 98 warm keep : approx. 14.5 min.

From 90 warm keep : approx. 16.5 min.

From 80 warm keep : approx. 20.5 min.

(Amount of water: Maximum
Room temperature: 20°C)

Caution

A lot of steam may occasionally come up

Care & Cleaning

Daily Maintenance

Clean with Citric Acid

(Before cleaning, be sure to disconnect the plug from outlet, dispense water and cool down the unit.)

Main unit and lid

Clean with a damp, well-wrung cloth.

- Do not wet or soak the main unit in water.
(If water enters the main unit from the bottom or from the dispensing spout, it can also get into the electrical components in the main unit and may cause a malfunction.)
- Do not use detergents. (They may leave an odor.)
- Do not use benzine or thinner. (They may damage the surface.)

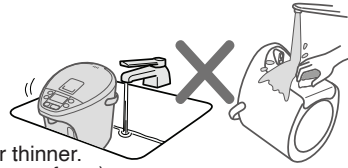

Inner container

Clean with a wet soft sponge.

- Do not use polishing powder, a scrub brush or a nylon brush.
(They may damage the fluororesin finish of the inner container.)



About "Scale"

While you are using this unit, minerals contained in the water (like calcium) can get stuck on the inner container or on the mesh filter. This is called "scale", and it is harmless.

- Milky-white gritty surface (caused by calcium)
- White or glittering floating material (crystals of minerals)
- Discoloration in the finish like dark brown, gray, or green areas (metallic ion made on the fluororesin covering)

These are not discoloration or corrosion of the inner container itself, nor are they flakes from the fluororesin covering.



Clean the inner container using citric acid. (⇒ P.15)

Active ceramic filter

Shake in water roughly every few months, and scrub the surface with soft sponges.

- Do not wash with detergent. (It causes odor remain)
- Do not use dishwasher with dryer or dish dryer. (It causes deformation)



Mesh filter

Clean the filter with a brush.

When filter is clogged, water does not flow smoothly.

- * After cleaning the filter, be sure to reattach it to the inner container.



When storing the unit

- Dry it thoroughly.
- Put it into a plastic bag and seal the bag to keep insects from getting in.

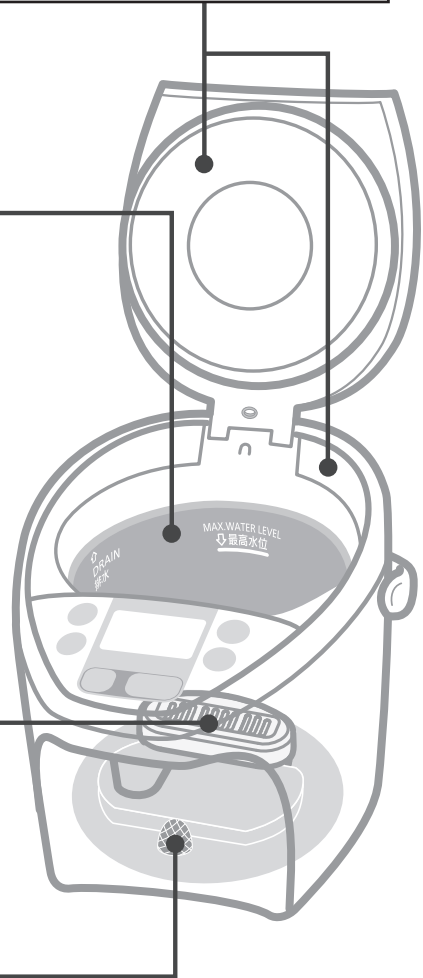

How to clean the inner container using citric acid.

(Once every two or three months to clear scale.)
 (More frequent cleaning may be required depending on the usage conditions.)

1 Make sure that the mesh filter is attached to the container.

2 Put citric acid in the inner container.

- Amount of citric acid to be used at one time:
 80 g (two packages) or seven level tablespoons.

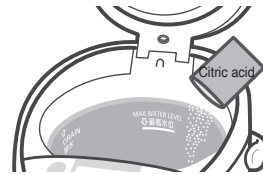

The citric acid is available from an authorized dealer. (Model No: SAN-80N)

- * Follow the directions for cleaning printed on the citric acid package.
- * Since the citric acid used for cleaning is a food additive, it is harmless to humans.

3 Add water to the maximum water level mark, and mix the citric acid and water well. Close the lid.

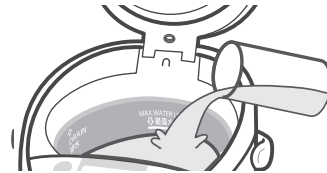

4 Connect the plug, and choose “cleaning” by **Select**.

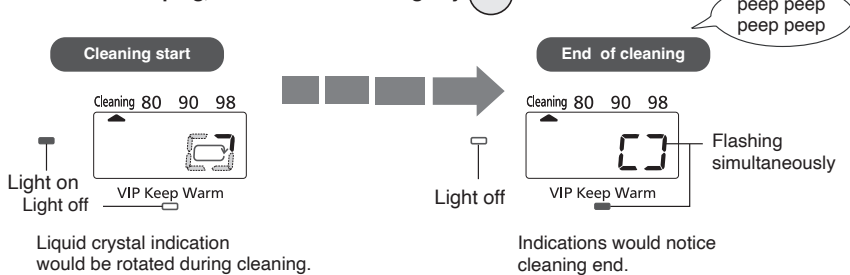

5 Dispense some water, then unplug, remove the lid and drain away the hot water via the “DRAIN” mark.

6 Refill with water and boil it to remove the smell of the citric acid. Then throw the hot water away in the same way as 5.

- To remove any discoloration from the area above the maximum water level, rub the inside lightly with a wet sponge.
- If the discoloration cannot be removed by rubbing, clean the inner container several times using citric acid.
- When washed without removing ceramic filter, wash the active ceramic filter, fix it in the inner container and drain away the initial boiled water before use.



Requests

- Make sure only use citric acid for thermo pot washing.
- Do not fill water above maximum water level.
- Fill the container only with tap water (do not fill with hot water). Hot water may spout out causing burns.

Troubleshooting

Before calling a service supplier, please check the following possible causes.

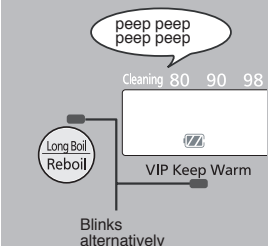
Troubleshooting

If...	Possible cause	How to fix
White or glittering flakes floating in the hot water.	<ul style="list-style-type: none"> The cause of this is "scale". (⇒P.14) It is not flakes of fluororesin. * Water with a large content of minerals in it such as mineral water or ionised water, is more likely to cause a scale or white layer in the hot water. 	<ul style="list-style-type: none"> Clean the inner container with a wet sponge. (⇒P.14) If the "scale" still remains, clean with citric acid. (⇒P.15)
Boiling sounds become louder.	<ul style="list-style-type: none"> When "scale" adhered, boiling sounds become louder. 	
Hot water has odors of chlorine.	<ul style="list-style-type: none"> Odors of chlorine remain depending on the amount of chlorine in tap water. 	<ul style="list-style-type: none"> Press the "Long Boil / Reboil" key to reduce the chlorine. (⇒P.10)
Hot water has an unpleasant odor.	<ul style="list-style-type: none"> When the unit is new, resin used in the manufacturing may give off a mild odor. This will disappear with use. If the unit is placed on surfaces such as a vinyl sheet, the odor may be carried over into the water. 	
Hot water comes out by itself.	<ul style="list-style-type: none"> Water has been added above maximum water level. 	<ul style="list-style-type: none"> Lower the water level.
Hot water does not flow out smoothly.	<ul style="list-style-type: none"> The mesh filter may be clogged with "scale". (⇒P.14) 	<ul style="list-style-type: none"> Clean the filter with a brush. If the "scale" cannot be removed, replace the filter. (⇒P.17)
Hot water does not dispense.	<ul style="list-style-type: none"> The automatic lock has been engaged. 	<ul style="list-style-type: none"> Press the "Lock / Unlock" key.
Lamp blinks while buzzer sounds (Power supply stops)	No-water boiling prevention function <ul style="list-style-type: none"> To prevent overheating, this is activated when it boils without water. Is water filled higher than water supply level ? Is the lid left opened when water is filled ? 	<ul style="list-style-type: none"> Fill the water higher than water supply level, close the lid and press .
	<ul style="list-style-type: none"> It may light on: <ul style="list-style-type: none"> when hot water is filled. depending on method of filling water. Is citric acid settled at the bottom of container while citric acid washing ? 	<ul style="list-style-type: none"> Press .
		<ul style="list-style-type: none"> Once disconnect the plug, mix with chopsticks and wash after citric acid is distributed. (⇒P.15)

Boiling without water will cause odor and change the color of fluorine resin.

The unit doesn't turn on electricity.

- You poured in water directly from a tap.
- You put the unit on the sink.
- You turned the unit upside down with its bottom wet.
- You washed the unit in water.

• It is broken if the electric components are taken in water. Contact the store where you purchased for repair.

- If it cannot be recovered or feel something strange, disconnect the plug, reconnect after 30 seconds and operate it again.
- Inside lid may turn yellow, but no harm for operation.
- "Clickety-clack" sound caused when open and close the lid is the sound caused by the valve swing to prevent the hot water run off.
- Outside body becomes 45°C while warm keep if the room temperature is high.

The indicator lights flash alternately and displayed H1, H2.

• This is malfunction of the sensor. Contact the stores where you purchased.

Replacement of Parts

Rubber gasket set

Replace gaskets if they crack, lose their pliancy or, for any other reasons which allow steam to escape from between the container and the lid.

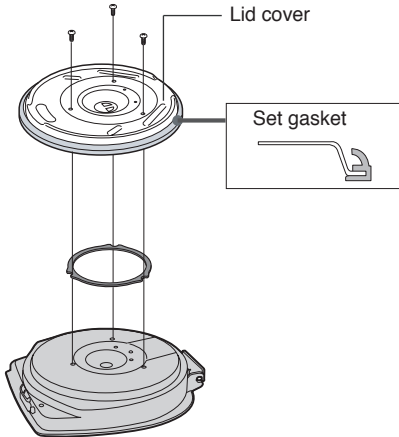

Remove lid, unscrew 3 tapping screws and remove the lid cover. Exchange the gaskets and then place the lid cover back and secure with the tapping screws.

Mesh filter

Replace the filter, if foreign materials which clog the filter cannot be removed, even after you scrub with a cleaning brush, etc.

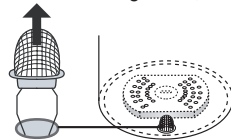

Ceramic filter

Rough replacement period : 1 year



Consumable parts are available from an authorized dealer.

Part name	Part No.
Rubber gasket set	APH65-61300S
Mesh filter	APB97-480-0U
Ceramic filter	APC58H667-0U

主要特點

美味

使用金剛氟和備長炭燒水。

- 鑽石和備長炭粉的粒子與氟混合作內瓶。
茶的颜色、味道和香味可以保存。

陶瓷濾器

(請參閱第 23 頁有關如何安裝)

- 大約 90% 的氯、菌類氣味和三鹵甲烷被濾去。
(可消耗部件,請參閱第 31 頁)

健康的沏茶方法

(如何使用,請參閱第 27 頁)

- 燒水被鹼化,和幫助萃取兒茶酚等茶的成分。

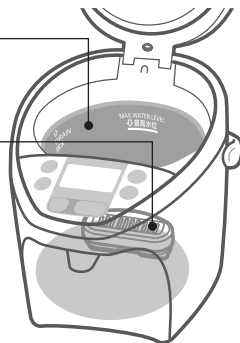

方便

熱水可以以4種速度按出

(如何使用,請參閱第 25 頁)

- 所按出的熱水容量視按的力度和出水時間而有所不同。

無電線按熱水

(如何使用,請參閱第 25 頁)

- 熱水在電線被拔除後仍然可以被按出。

指示燈

- 給水時,指示燈顯示水位,以保證安全和準確。

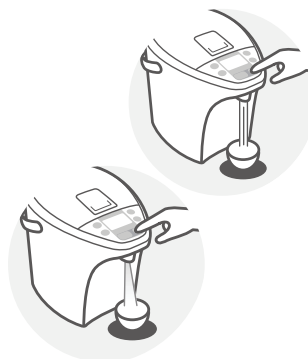

使用經濟

● 4個定時器選擇

可以選擇 4 / 6 / 8 / 10 小時定時器。

(請參閱第 27 頁的“設置定時器”)

● 節能

加熱器被控制以配合使用目的。通過在出水時燒水和在沒有出水時關閉加熱器以自動節省電力。

● 3個保暖溫度選擇

可以選擇 98 / 90 / 80 保暖溫度。

(請參閱第27頁的“保溫功能”)

● VIP保溫

熱絕緣器保持熱水溫度,因此可以節省電力。

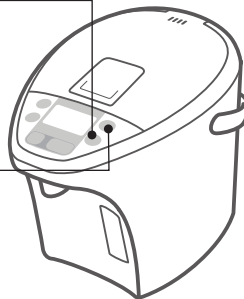

安全注意事項

務必遵守

為確保您的安全和避免財物損壞和危及用戶，請細讀以下指示。

■ 當產品使用不當，此信號表示危險和損壞。



警告

這一標示欄表示“可能會導致死亡或重傷等”的內容。



注意

表示“可能會導致用戶受傷或有關產品可能會導致財物受損。”

■ 下面符號表示務必遵守的詳細事項。



這個符號表示必須禁止的事項。



這個符號表示強制命令。



警告

為防止燙傷



- 本裝置不適合有殘障、智障或精神障礙的人士、缺乏經驗及常識者（包括兒童）使用，除非負責其安全的人士在場監督或指導。應監督兒童，勿讓他們將產品當作玩具。

- 勿讓本體翻倒。勿提著上蓋來傾斜、搖晃或搬動主機。即使已鎖住出水按鈕，熱水瓶若傾斜或翻倒，熱水也會從出水口和蒸氣口流出，導致燙傷。

- 倒入水時不要超過滿水標記
如果加水過多，可能會噴出沸水
否則，熱水溢出，可致燙傷。

- 不要大力關閉上蓋
否則，熱水溢出，可致燙傷。

- 不要用來燒水以外的東西
若用來煮沸茶包、茶葉、牛奶、酒或其他以外的液體，它們可能會起泡噴出，可致燙傷。
而且會引致出水管堵塞、燒焦或腐蝕內瓶、氟素樹脂脫落。

- 不要阻塞蒸氣口
否則，熱水溢出，可致燙傷。

- 倒掉剩水時要卸下上蓋
若上蓋鬆脫，熱水可能會濺出導致燒傷。

- 不要用手觸摸蒸氣口
否則，可致燙傷。
尤其是注意不要讓幼兒觸摸。

- 確保關好上蓋
萬一本體翻倒時，熱水流出，可致燙傷。

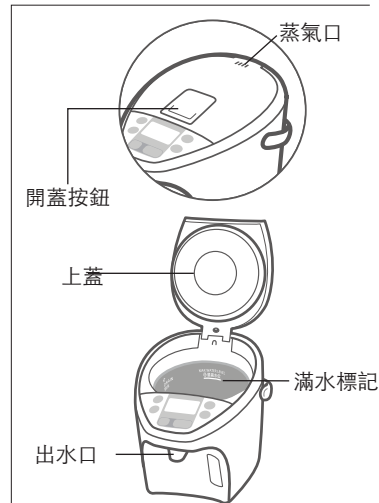

安全注意事項

務必遵守

警告

電源軟線



● 不要損壞軟線、電源插頭、主機插頭

不得劃傷、不得加工、不得靠近發熱器具、不得強行彎曲、不得扭轉、不得牽拉、不得壓放重物、不得打捆。
使用損壞的軟線和插頭，可致觸電、短路、火災。

➔ 若主電源線損壞，必須由原廠、其服務中心或類似的合資格人士更換，以免產生危險。

● 不要用濕手操作電源插頭和主機插頭

否則，可致觸電。

● 別讓嬰孩接近插頭！

您必須特別留意以避免嬰孩將插頭放入嘴裏。
這可能會導致觸電或受傷。

● 別讓小件的金屬零件放在插頭附近。

這可能會導致觸電、短路或火災。

● 確保已正確插入電源插頭

未完全插入時，可致觸電、發熱而引起火災。

➔ 不要使用損壞的插頭和鬆動的插座。

● 定期擦拭電源插頭和主機插頭

插頭堆積灰塵，可因潮濕導致軟線損壞或絕緣不良而引起火災。

➔ 拔下插頭，用乾布擦拭。

● 單獨使用符合額定電源的電源插座

若與其它電器產品共用，可致發熱，發生火災。

電源軟線

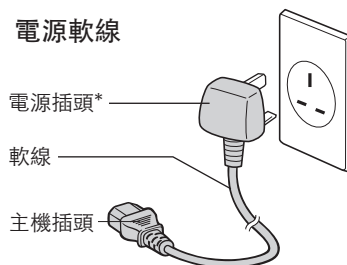

*電源插頭的形狀可能與所示圖片不同。



操作



● 不要將熱水瓶放在水中或濺水於主機

● 請勿用水龍頭直接供水，或將本機置於水槽之中，否則底部可能會弄濕。

● 當底部變濕時，請勿將主機倒置。

這可能會導致電流短路和可能導致觸電，若水溢出容器並滲入主機內置的電器零件則可能會導致故障。

● 千萬不要拆裝、修理和改造

否則，可致火災或異常運作而造成損害。

➔ 修理時（除更換易耗品），請諮詢維修中心。

● 不要放入冰塊用作保冷

否則，可致結露而引起觸電或故障。



注意

為防止燙傷



- 不要放在不穩定的地方
否則，熱水瓶翻倒，可致燙傷。
- 煮沸中不要打開上蓋或倒熱水
否則，熱水飛濺和蒸氣噴出，可致燙傷。
- 倒水時，不要轉動主機
否則，熱水飛濺，可致燙傷。
- 放置把手時應遠離蒸汽。
- 打開或關閉蓋子時，注意手要避開蒸氣口
否則，可致燙傷。
- 使用中或剛用過後，不要觸摸主機等高溫部分
否則，可致燙傷。
- 搬動主機時，不要觸摸開蓋按鈕
否則，上蓋突然開啟，可致燙傷和受傷。



- 使用後加熱元件表面會殘留熱量。等到本產品冷卻後才可觸摸或進行清潔。
發熱的產品可能導致灼傷。
■ 當廢棄熱水時，請注意不要被燙傷。

電源軟線



- 切勿使用其他電線，或把此電線駁上其他電器
(切勿使用非特別為本機設計的電線。)
否則，可致故障及火災。



- 不使用時，從電源插座上拔下電源插頭
否則，因絕緣老化可致觸電、漏電，引起火災。
- 拔下電源插頭時，務必握住電源插頭部分，不要牽拉軟線
否則，可致觸電、短路，引起火災。

操作



- 水量在低於給水標記下應加水。
- 切勿倒水太快。
若水濺到蓋子的開蓋部分或操作面板，這可能會造成故障。
- 請勿讓水留在內瓶中。
(否則，可能會導致內瓶腐蝕或產生異味)
- 切勿在散熱差的表面使用本機。
否則，將會變色或破損。
- 不要靠近牆壁和家具
否則，蒸氣和熱量可損壞牆壁和家具，引起變色或變形。



- 墊圈變白的話，請更換。
否則，發生意外而主機傾倒時，熱水會流出。
- 本產品僅供家居使用。
- 確保使用後清潔接觸食物的表面。
(見第 28 至 29 頁“保養和清洗”。)

各部分名稱和操作方法

操作顯示面板

面板表面貼有保護薄膜時，請撕掉後才使用。

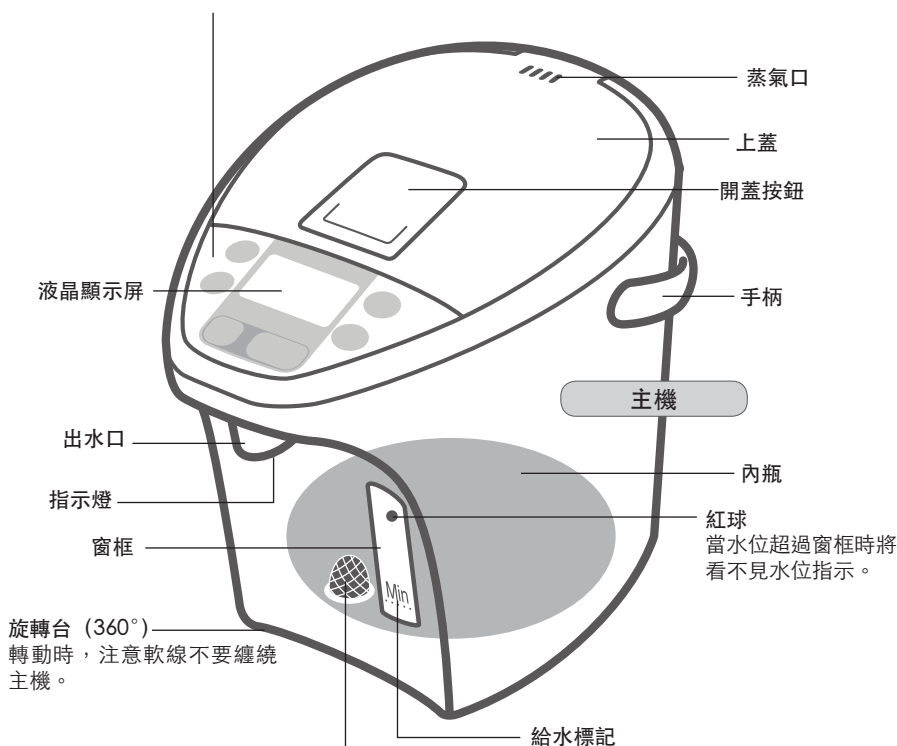

過濾網

(易耗品)

它可能從容器底部脫落。脫落時將它完全推入其正確位置。(⇒ 第 31 頁)

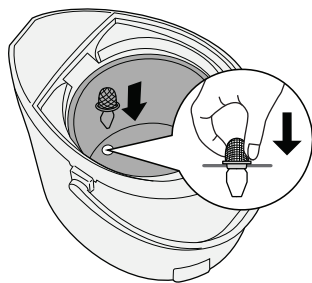

電源軟線

電源插頭*

軟線

主機插頭



*電源插頭的形狀可能與所示圖片不同。

使用前的準備工作

第一次使用前

加水入內煮沸以清洗熱水瓶容器和出熱水的部分。

- 1 煮一些水。
- 2 按出熱水。
- 3 通過“DRAIN”標記倒空瓶子。

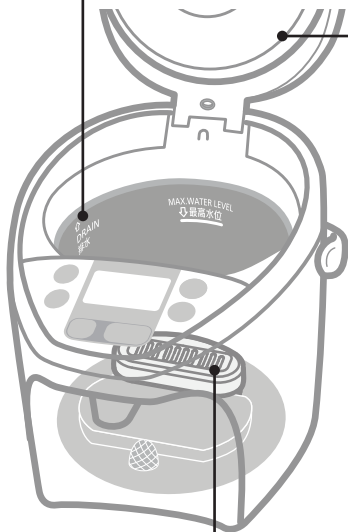

如何拆除上蓋

- 1 按開蓋按鈕,打開上蓋然後拉開球形捏手。



- 2 打開上蓋。

如何關上: 按直至發出“喀噠”聲。

- 2 斜斜地往上拉。

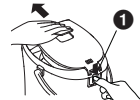

- 1 只需輕按球形捏手，

如何設定: 斜斜地從上插入上蓋。

如何設置陶瓷濾器

- 1 在水內抖動。



- 2 設至後部。

用磁鐵固定位置

加熱器表面

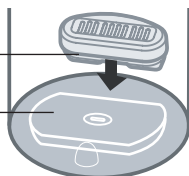

處理

- 切勿用清潔劑清洗(這會造成異味)
- 切勿貼在加熱器表面(這會造成故障)
- 切勿放在對磁力敏感的物體附近,例如信用卡。



使用經濟

設置能源節省及定時器 (⇔ 第26頁)

- 可配合使用習慣控制加熱器。
在想使用熱水的時段內保持沸騰,
在不想使用熱水的時段內自動切
斷加熱器,節約保溫的電量。
- 開始使用後會自動將出水時段儲
存紀錄。
- 使用一週後會按照過往一週所儲
存的出水時段紀錄為基準,自動
提高保溫溫度。

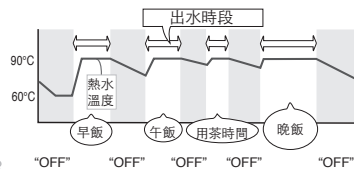

使用方法

燒水

倒水

使用方法



※ 給水標記
水量在低於給水標記下應加水。

燒水

給水

要減少氯味時 (Long Boil / 長時間沸騰)

按下  鍵，指示燈閃爍。

(在水煮沸中，按1次；在水保溫中，按2次。)

延長燒水時間大約7分鐘以減低水內大約90%的氯。

● 要返回煮沸時，再按一次  鍵。

加水後

如果沒有自動開始燒水。

 按下使提示燈亮起。



加水和關上上蓋後接上電源插頭。(① → ②)

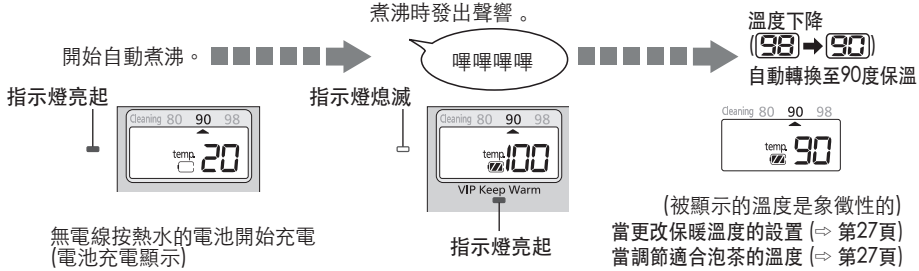

所按出的熱水容量視按的力度和出水時間而有所不同。

	出水時間(持續按的時間)		
	5秒鐘以下	5至12秒鐘	12秒鐘以上
輕輕按		LEVEL ▬	
用力按	LEVEL ▬▬	LEVEL ▬▬▬	LEVEL ▬▬▬▬

※ 用力按時小心熱水回彈

當進行無電線按熱水 (僅2段給水)。



- ※1 若時常按水,盛滿容量可能不會被顯示。
- 8-10小時後,即使沒有按水,指示燈會熄滅並且不能再按熱水。

電線被拔除後給水。(無電線按熱水)

倒水量指標

電池充電容量	給水容量
	大約3公升或以上 ※ 1
	1.5公升或以下

在室溫20°C的情況下,水溫在煮沸1小時後跌至90°C。

※ 水量越小溫度下跌速度越快。

不使用時

拔掉電源插頭,取下上蓋。通過 **DRAIN** (排水) 標記,慢慢倒掉所有剩餘的熱水。

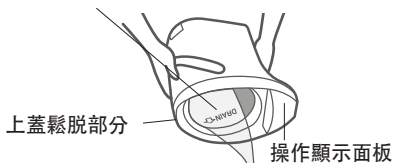

要求

- 切勿倒水太快。
(若水濺到蓋子的開蓋部分或操作面板,這可能會造成故障。)
- 請勿讓水留在內瓶中。
(否則,可能會導致內瓶腐蝕或產生異味。)

方便的使用方法

定時器

能源節省

方便的使用方法

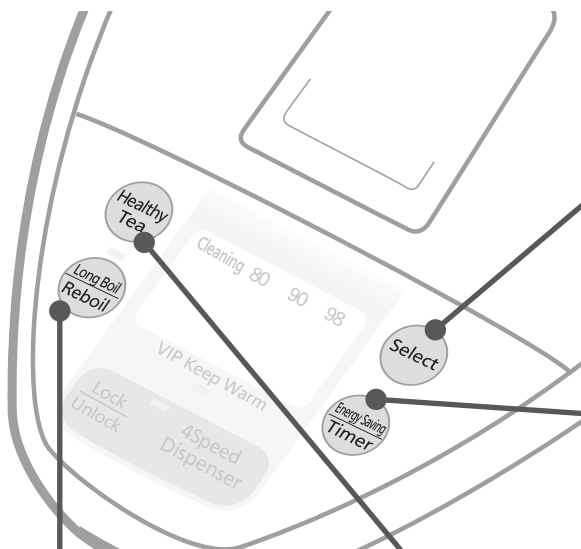

保溫功能

- 泡綠茶最好使用 80°C 保溫。
- 保溫溫度越低越節省能源。
- 大約 80°C 的水溫最適合天然茶葉茶。

當短時間內不會使用本機,例如當您要外出...

設置定時器

- 設置定時器時,加熱器電源被中斷

設置能源節省

- 沒有使用時不會煮沸(保持最低大約 60°C 的溫度)並加熱至預設溫度以調節時間以便使用。
- 建議您如此設置若出水時間通常固定。

注意

- 在水沸騰或保溫期間可以設定保溫溫度或定時器。
- 在發生電源和顯示故障而又恢復供電後,即使以前選擇了定時器或“98”或“80”保溫功能,保溫溫度仍將會自動設定在90。

重新煮沸

- 沖咖啡 / 泡茶 / 泡杯面等等時,最好使用沸水。

重新煮沸的時間

從 98 保溫: 約 4.5 分鐘
從 90 保溫: 約 6.5 分鐘
從 80 保溫: 約 10.5 分鐘
(水量: 最大)
(室溫: 20°C)

按下  鍵, 將正在保溫的水重新煮沸。



幾分鐘後, 水將沸騰。
● 保溫溫度和節約定時器的設定無變化。



保溫功能

重新煮沸

健康茶

每次按 **Select** 按鈕，
“▲” 標記將會跳至下
一個選擇同時更改保溫
溫度。
Cleaning 80 90 98
↑ ← ▲ → ↓

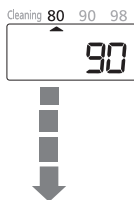

降至所設定的保溫溫度時所需的
時間

90 → 80 保溫：約 0.3 - 1.0 小時
98 → 90 保溫：約 0.7 - 2.0 小時

(水量：最大
室溫：20°C
以前的保溫設定值：90)

一段短時間後，燒水將會被保暖在大約80°C

水會在8小時後再次煮沸

每次按 **Energy Saving Timer** 按鈕，指示
燈將會跳至下一個選擇。

4h → 6h → 8h → 10h

↑ 取消 ← Energy saving ↓
(將返回溫度顯示)

8h

剩餘時間將會以1小時為基本計算。

取消定時器，再按 **Energy Saving Timer** 按鈕

8小時後，定時器將解除並開始燒水
當水被煮至沸點時轉換至保暖。

若設置了“能源節省”



出水時間前開始煮沸
並保持在預設溫度。



沒有出水時顯示“OFF”。

“OFF” 指示燈熄滅。

小心

當設置了能源節省，本機自動在出水時間煮水。
若同時與其它設備一起使用，斷路器可能會跳開。

方便的使用方法

Healthy Tea

按



煮沸時發出信息
(保暖溫度設置不變。)

嗶嗶嗶嗶

指示燈亮起



閃爍



指示燈亮起

煮沸時間

加入水後：大約 41 分鐘
98 保溫：大約 14.5 分鐘
90 保溫：大約 16.5 分鐘
80 保溫：大約 20.5 分鐘

(水量：最大
室溫：20°C)

注意

當 **Tea** 指示燈亮起時加水，設置會被解除。(Tea 指示燈熄滅)

當 **Tea** 閃爍時按 **Energy Saving Timer**、**Long Boil Reboil** 和 **Healthy Tea** 按鈕，設置將會被解除。

小心

大量蒸氣可能會偶爾湧出

保養和清洗

日常保養方法

請用檸檬酸清洗

(清潔之前，必須從插座上拔掉插頭，倒掉內瓶裡的水，並讓本機冷卻。)

主機、上蓋

用檸檬乾的濕抹布擦拭。

- 不要把主機浸於水中。
(否則，水從底部和出水口進入內部，浸濕主機內的電子器件，可致故障。)
- 不要使用洗劑。
(否則，可留有異味。)
- 不要使用汽油、天拿水等溶解液。
(否則，可損傷表面。)

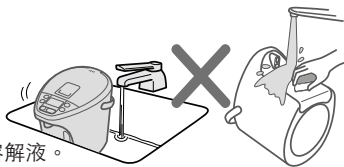

內瓶

用濕海綿清洗。

- 不要使用去污粉、草刷、尼龍刷。
(否則，可損傷氟素樹脂塗層。)



關於“水垢”

使用過程中，水中含有鈣質等礦物成分會附在內瓶和過濾網上。這稱為“水垢”，對人體無害。

- 乳白色顆粒狀 (由鈣質產生)
- 白色或閃光的浮游物 (礦物成分的結晶體)
- 茶色、灰色、綠色等變色 (氟素樹脂塗層上的金屬離子)

這些既不是內瓶本身的變色或腐蝕，也不是氟素樹脂塗層的剝落所致。



請用檸檬酸清洗內瓶。(⇒第29頁)

活性陶瓷濾器

每數個月用力在水內抖動並用軟海綿擦拭表面。

- 請勿用清潔劑洗。
(這會導致異味)
- 請勿用有烘乾機的洗碗機或烘碗機。(這會造成變形)



過濾網

用刷子等清洗。

當過濾網堵塞時，水流可能會不暢。

* 清洗後，務必重新裝在內瓶中。



儲存時

- 將其充分風乾。
- 將其放入塑料袋中然後密封以避免昆蟲進入。

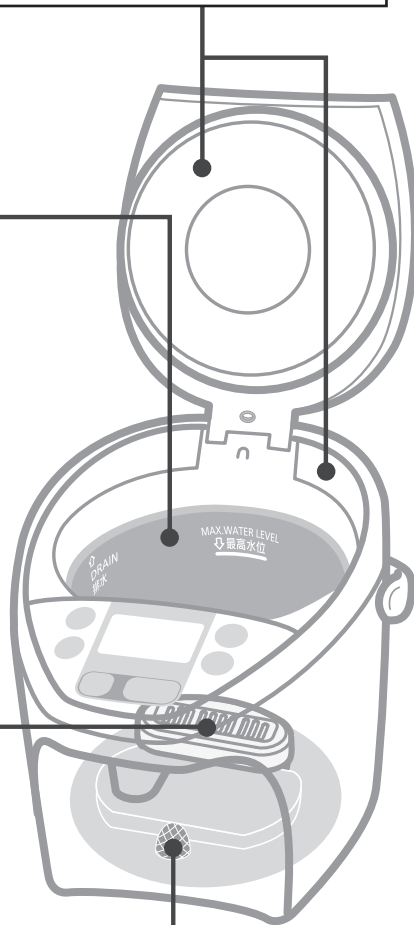

當附著水垢時，請用檸檬酸清洗

(積垢須每兩、三個月清理一次。
視乎使用情況，產品可能需要更頻繁清潔。)

1 確認內瓶內已裝好過濾網。

2 將檸檬酸放入內瓶內。

- 檸檬酸清洗一次用量
80克 (2袋) 或大茶匙7平匙

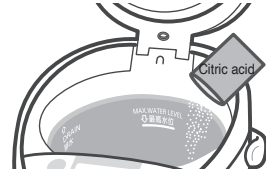

請在經銷店購買清洗用檸檬酸。(型號：SAN-80N)

- *請遵守清洗用檸檬酸附屬的說明書注意事項。
- *清洗用檸檬酸屬於食品添加物，無礙食品衛生，對人體無害。

3 加水至最滿水標記，將檸檬酸與水充分混合。關上上蓋。

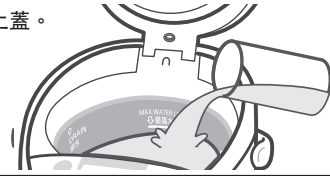

4 接上插頭，然後選擇 (Select) 內的“cleaning”。

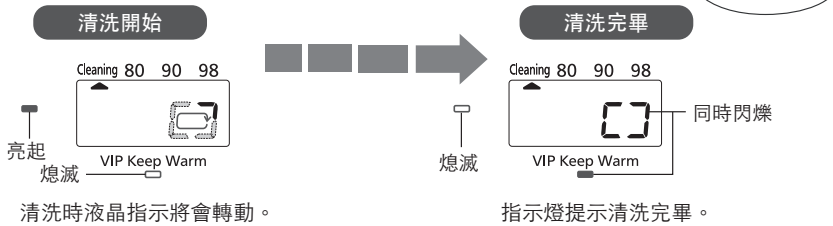

5 流出一些水後拔掉拔掉插頭，拆下蓋子，通過“DRAIN (排水)”標記，倒掉熱水。

6 重新裝滿水然後煮沸以清除檸檬酸或檸檬的味道。
然後使用步驟5相同的方法將熱水倒掉。

- 若要清除最高水位以上的變色，用濕海綿輕輕擦拭。
- 如變色嚴重，一次不能清除時，可重覆用檸檬酸清洗內瓶。
- 若在沒有拆除陶瓷濾器的情況下清洗，使用前請把活性陶瓷濾器清洗，裝入內瓶，把首次煮沸的水倒去。

要求



- 只用檸檬酸清洗熱水瓶。
- 加入的水不要超過滿水標記。
- 從冷水開始煮沸 (不要加入熱水)。否則，熱水起泡噴出，可致燙傷。

每兩個或三個月一次以清洗水垢。

故障排除

委託修理商之前，請檢查一下問題可能性。

故障排除

徵狀	原因	解決方法
熱水中有白色或閃光的浮游物。	<ul style="list-style-type: none"> 這是脫落的“水垢”（⇒ 第28頁），不是脫落的氟素樹脂。 * 礦物質多的水（礦泉水、離子淨水器處理的水）易於產生水垢，附在內瓶上或浮在水中。 	<ul style="list-style-type: none"> 用濕海綿清洗內瓶。（⇒ 第28頁） 如果仍有“水垢”殘留，請用檸檬酸清洗（⇒ 第29頁）
煮沸的聲音變得更大。	<ul style="list-style-type: none"> 當附著“水垢”時，煮沸聲音將變得更大。 	
熱水有氯的氣味。	<ul style="list-style-type: none"> 自來水中含有較多消毒用氯，可產生氯味。 	<ul style="list-style-type: none"> 按下“Long Boil / Reboil”鍵來減低氯味。（⇒ 第24頁）
熱水有令人討厭的異味。	<ul style="list-style-type: none"> 若本機尚新，生產過程所使用的樹脂可能會產生異味。這會在使用時消失。 若將本機放在乙烯基墊子等等表面上使用，墊子的氣味可能會被傳入水內。 	
熱水自然流出。	<ul style="list-style-type: none"> 加水是否超過滿水標記。 	<ul style="list-style-type: none"> 減少水量。
熱水出水不順暢。	<ul style="list-style-type: none"> 過濾網可能已被“水垢”堵塞。（⇒ 第28頁） 	<ul style="list-style-type: none"> 用刷子刷洗刷不掉時，應更換過濾網（⇒ 第31頁）。
不出水。	<ul style="list-style-type: none"> 自動鎖定功能已啟動。 	<ul style="list-style-type: none"> 按下“Lock/Unlock（鎖定/解除）”鍵。
指示燈閃爍同時蜂鳴器發出聲響（供電中斷）	<p>沒有防止煮沸功能</p> <ul style="list-style-type: none"> 防止過熱故障，這在沒有水加熱時啟動 被加入的水是否超過水位標記？ 加水時上蓋是否開著？ <p>它可能亮起：</p> <ul style="list-style-type: none"> 當加入熱水。 視加水方法而定。 <p>用檸檬酸清洗時檸檬酸是否沉積在瓶底？</p>	<ul style="list-style-type: none"> 加水直至超過水位標記，關上上蓋然後按 。 按 。 拔出插頭後，用筷子把檸檬酸拌勻後清洗。（⇒ 第29頁）

若在沒有水的情況下煮水，將會發出臭味或含氟樹脂的顏色改變。

本體不能通電

- 從水龍頭出水口直接加水。
- 本體放在水槽中。
- 本體倒置，底部仍然未乾。
- 用水清洗了本體。

● 如果電器零件已沾上水可能產生故障。請與購買經銷商聯繫修理。

- 若無法恢復或發現有任何不妥，拔出插頭，在 30 秒鐘後重新連接然後再次操作。
- 內上蓋可能會變黃，但是對操作沒有不好的影響。
- 打開和關上上蓋時發出的“喀嚓喀嚓”聲是閥轉動避免熱水流出來時製造出來的聲音。
- 機身外的溫度會在室溫高時保暖為 45°C。

指示燈交替閃爍
和顯示 **H1** **H2**。

- 這是因為傳感器故障。請聯絡您購買本機的商店。

更換易耗品

密封墊圈套件

失去柔軟性或產生裂紋，從上蓋的間隙中漏出蒸氣時，應更換密封墊。

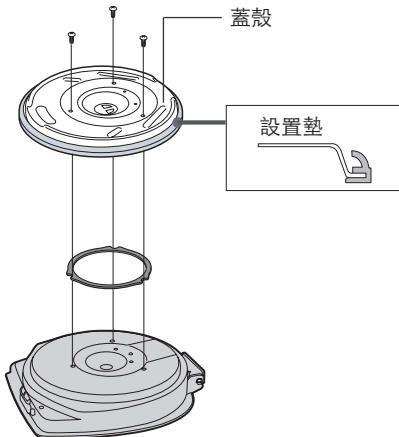

卸下三支螺釘，取下蓋殼，更換密封墊。再把蓋殼裝上，扭緊螺釘。

過濾網

若使用刷子刷洗仍無法清除堵塞過濾網上的異物，請替換過濾網。

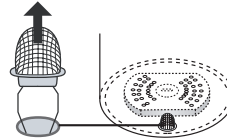

陶瓷濾器

更換時間:1年



請在經銷店購買易耗品。

易耗品名稱	易耗品編號
密封墊圈套件	APH65-61300S
過濾網	APB97-480-0U
陶瓷濾器	APC58H667-0U

Specifications

Model No.	NC-SU403P	
Power	220 V ~ 50 Hz	
Power consumption	875 W	
Power consumption while keeping warm *1 (per hour) (approx.)	98 warm keeping	19 Wh
	90 warm keeping	16 Wh
	80 warm keeping	13 Wh
Dimensions (approx.) (where handle is turned.)	Width	24.7 cm
	Depth	34.5 cm
	Height	33.9 cm
Weight (approx.)	3.3 kg	
Rated capacity	4.0 L	
Motor pump	Power consumption 1.5 W/Rated time 3 min.	
Overheating prevention unit	Thermal fuse	
Boiling time *2 (approx.)	31.0 min.	
Cleaning time with citric acid	46 min.	

*1 : Full of water, where room temperature is 23°C.

*2 : Full of water, where room and water temperature are 20°C.

- Prescribed performance may not be maintained in particular areas such as highland or extremely cold region.
- Drain water if not used such as during winter. Remaining water may freeze and damage parts.
- Power consumption while keeping warm will be changed by following user environment.

規格

型號	NC-SU403P	
電源	220 V ~ 50 Hz	
耗電量	875 W	
保溫 *1 時的耗電量 (每小時) (大約)	98 保溫	19 瓦 / 時
	90 保溫	16 瓦 / 時
	80 保溫	13 瓦 / 時
尺寸(大約) (轉動把手的地方。)	寬	24.7 厘米
	深	34.5 厘米
	高	33.9 厘米
重量(大約)	3.3 公斤	
額定容量	4.0 公升	
電動泵	耗電量 1.5 瓦/額定時間 3 分鐘	
過熱保護組件	熱熔絲	
煮沸時間 *2 (大約)	31.0 分鐘	
使用檸檬酸的清理時間	46 分鐘	

*1 : 23°C 室溫以下盛滿水。

*2 : 20°C 室溫和水溫盛滿水。

- 所描述的性能可能無法在高地或極度寒冷等特定地區保持。
- 沒有使用時,例如在冬季時把水排出。請記住,水可能會結冰和損壞零件。
- 保溫模式的耗電量將根據用戶環境而變換。

Panasonic Corporation
<https://www.panasonic.com>
 © Panasonic Corporation 2012

PZ05H6674
 TP0912E40223
 Printed in Thailand