

Panasonic®

Operating Instructions Air Purifier Dehumidifier



Model No. **F-YAP21H**

This product is for indoor use only

Correct use will help you save electricity

Warranty card included Separately

Thank you for purchasing this **Panasonic** product.

- Please read these operating instructions carefully, in order to use the product correctly and in a safe manner.
- Please read the "Safety precautions" section (page 2 - 4) carefully before use.
- Make sure that the correct information is written on the warranty card, including the "date of purchase" and the "name of the distributor".
Send the warranty card back within ten days of purchase. Keep the warranty documentation in a safe place along with the operating instructions for future reference.

Contents

<Page>

| Safety precautions..... | 2~4 | Preparing for use |
|--|-------|--------------------------|
| Preparation..... | 5 | |
| Parts name..... | 6 | |
| Control panel..... | 7 | |
| Note..... | 8 | |
| Air detector indicator (PM2.5 detection / Odor detection)..... | 9 | |
| <hr/> | | |
| Operation mode / Air volume selection..... | 10 | Operation |
| To set humidity..... | 11 | |
| Laundry mode..... | 12 | |
| nanoe™ bacteriostasis and deodorization..... | 13 | |
| Air direction selection..... | 14 | |
| Timer / sound / key lock settings..... | 15 | |
| Handling of a fallen air guide blade / full water tank..... | 16 | |
| How to drain continuously..... | 17 | |
| Maintenance..... | 18~20 | |
| About Laundry mode..... | 20 | |
| <hr/> | | |
| Fault..... | 21~22 | Trouble shooting |
| Emergency measures..... | 23 | |
| Optional parts..... | 23 | |
| Specifications..... | 24 | |



The appliance is not intended for use by persons (including children) with reduced physical , sensory or mental capabilities , or lack of experience and knowledge , unless they have been given supervision or instruction concerning use of the appliance by a person responsible for their safety . Children should be supervised to ensure that they do not play with the appliance . If the supply cord is damaged , it must be replaced by the manufacturer , its service agent or similarly qualified persons in order to avoid a hazard . Please disconnect the power plug and empty the tank before doing any maintenance work .

Safety precautions



Always pay attention to these precautions

To prevent users and others bodily harm or property losses, we are explaining the precautions must be observed.











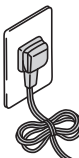

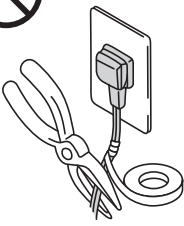

■ Ignoring the symbols incorrect operation, can result in harm or level of damage, described in the following two categories.

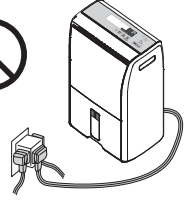
| | | |
|---|----------------|--|
|  | WARNING | This symbol indicates the "Possibility of death or serious injury". |
|  | CAUTION | This symbol indicates the "Possibility of injury or damage to property". |

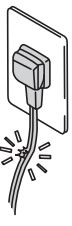
■ Meanings of symbols that always observed are as shown below.

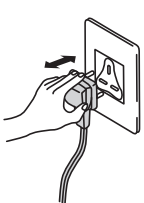
| | |
|---|--|
|  | This symbol indicates an action that "requires caution". |
|  | This symbol indicates a "never do this" action. |
|  | This symbol indicates an "always do this" action. |

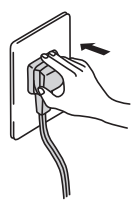

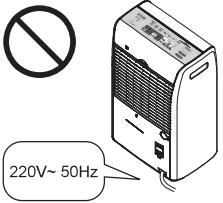
WARNING

| | | | |
|--|---|--|---|
| <p>■ Do not do anything that may damage the power cord or power plug.</p> <ul style="list-style-type: none"> • Power plug   <p>Do not damage, modify, bend strongly, pull, place heavy objects on top or binding with nylon yam or wire on power plug. If using damaged power cord, may result in electric shock, short circuit, causing fire.</p> <ul style="list-style-type: none"> ● If the supply cord is damaged, it must be replaced by the manufacturer, its service agent or similarly qualified persons in order to avoid a hazard. <p>■ Do not unplug the power plug with wet hands.</p>   <p>Electric shocks may occur.</p> | <p>■ Avoid the power cord if it is damaged or modified</p>   <p>Damage from heavy objects placed on top, heating, or pulling could cause fire or electric shock.</p> <p>■ Do not use overloaded the rated current of the power outlet and wiring equipment.</p>   <p>Use too many branch lines will exceed the rated current, it may cause a fire by overheating.</p> | <p>■ Do not use a damaged power cord</p>   <p>Using damaged power cord, electric shocks or fire may occur. Please consult with the dealership or service station.</p> <p>■ Do not start or stop the unit by plugging or unplugging the power plug.</p>   <p>It may cause fire or electric shocks by overheating.</p> | <p>■ Insert the power plug completely</p>   <p>If the power plug is not inserted securely, fire due to overheating may occur.</p> <ul style="list-style-type: none"> ● Do not use damaged power plugs or loose wall sockets. <p>■ Do not use the voltage other than as specified for unit.</p>   <p>It may cause fire or electric shocks by overheating.</p> |
|--|---|--|---|

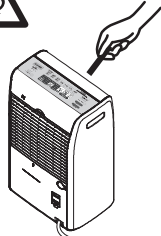

WARNING

- Do not insert your fingers or other objects such as sticks into the air outlet.



The high-speed rotating fan inside the machine may result in injury or electric shock.

- Do not unplug roughly.



Unplug roughly may damage the power cord and result in short circuit, fire or electric shock.

- Do not place the unit near a heater.

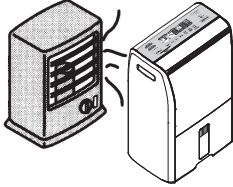

The resin parts may melt and lead to fire.

- Periodically clean the dust and dirt on the power plug.

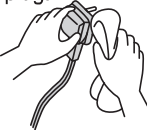

If dust accumulates on the power plug, humidity may cause damage to insulation and may result in fire.

- Unplug the power plug and wipe it with dry cloth. Unplug the power plug when the dehumidifier is not in use.

- Never try to repair the unit by yourself.



Fire or electric shock may occur.

- Please contact your direct service center or dealer for repair.
- Do not stretch the power cord.



It may cause short circuit or broken wires (which may cause fire or electric shock.)

- Switch off and then unplug out the power plug when error occurs (in case of the following situations)

- Incorrect On/Off operations.
- Switch electric leakage or fuse burned frequently.
- Power cord or power plug heats up abnormally.
- Burning smell or abnormal noise during operation.
- Water leakage from the unit.
- Other abnormal faulty condition.

These may cause fire or electric shock.

- Please contact your direct service center or dealer.

- Do not pull on the power cord when carrying or storing the dehumidifier.



It may cause short circuit or broken wires (which may cause fire or electric shock.)



CAUTION

- Monitor indoor temperature during prolonged operation.



During operation, heat from the unit may cause indoor temperature to rise, operating in closed room may cause discomfort.

- Pay particular attention if infants or the elderly are present.
- Do not operate in areas where water may be easily splashed onto the unit.

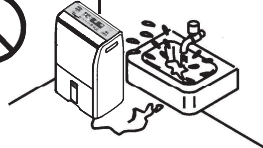

Fire or electric shock may occur.

- Place the unit on level and sturdy floor.

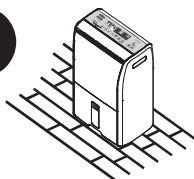

If the unit tilts, water will overflow, and wet the property potentially causing fire or electric shock.

- Do not use unit near flammable gas.



If flammable gases permeate the surrounding space, it may cause fire.

- Do not use in confined spaces such as closets.

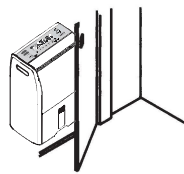

Poor air circulation may cause overheating or fire.

- Do not use in places exposed to direct sunlight, wind or rain.

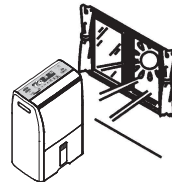

Resulting heat may cause fire or electric shock.

Safety precautions

This unit is not intended for use by persons (including children) with reduced physical, sensory or mental capabilities, or lack of experiences and knowledge, unless they have been given supervision or instructions concerning the use of the unit by a person responsible for their safety. Children should be supervised to ensure that they do not play with the unit.

CAUTION

- Do not use in place where there are artworks or academic documents.

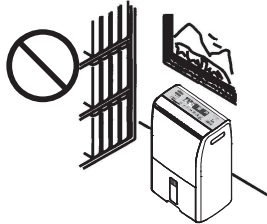

Deterioration of stored articles may occur.

- Do not place flower vases or other water container on top of the unit.



Water may spill into the unit and fire or electric shock may occur.

- Do not wash the Dehumidifier directly with water.

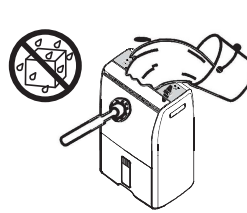

Fire or electric shock may occur due to electric leakage.

- Do not clean your product by spraying insecticides to it or wiping it with benzene or thinner.



Fire, Electric shock, damage to household items caused by water leakage may occur.

- Do not place any heat or flame producing instrument in air outlet of the unit.

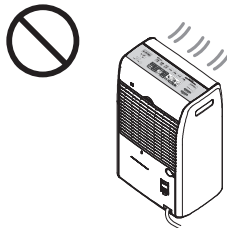

Incomplete combustion may cause carbon monoxide poisoning.

- Do not cover the air inlet or air outlet with cloths or towels.

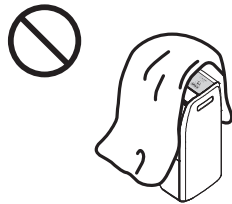

Air circulation will decrease and overheating or fire may occur.

- Do not sit or climb on the unit.



You may fall over, and injury may occur.

- Do not move or transport the unit by holding the air guide blade.



The unit may fall down and injury may occur.

- When moving the Dehumidifier, turn off the unit and empty the water in the water tank.



Fire, Electric shock, damage to household items caused by water leakage may occur.

- When the unit is to be cleaned, switch off and unplug.

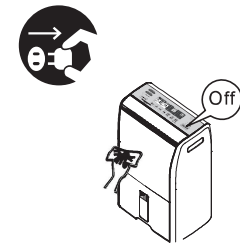

The high-speed rotation of the fan inside may cause injury.

- If unit will remain unused for a long period, unplug the power plug, for safety.

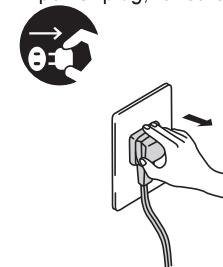

Accumulation of dust and foreign objects may lead to heat and fire may occur.

- After prolonged use, perform periodic inspection.



Particularly the air filter and drains should be checked routinely to avoid overheating and leakage, resulting in house fires and items wetted.

Preparation

Filter installation

1 Remove the air filter

- Pull the handle forward

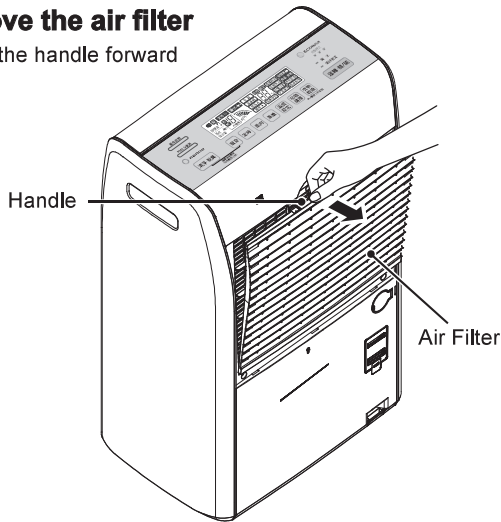

2 Take (2 types of) filters out from the plastic bags.

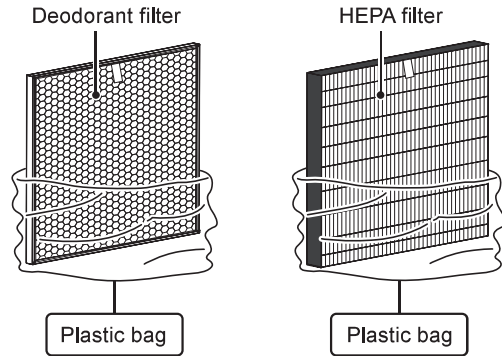

※ The HEPA filter is pre-installed in the unit at the factory, while the deodorant filter is placed with the Operating Instructions.

3 Installation procedures: attach the deodorant filter first, and then attach the HEPA filter.

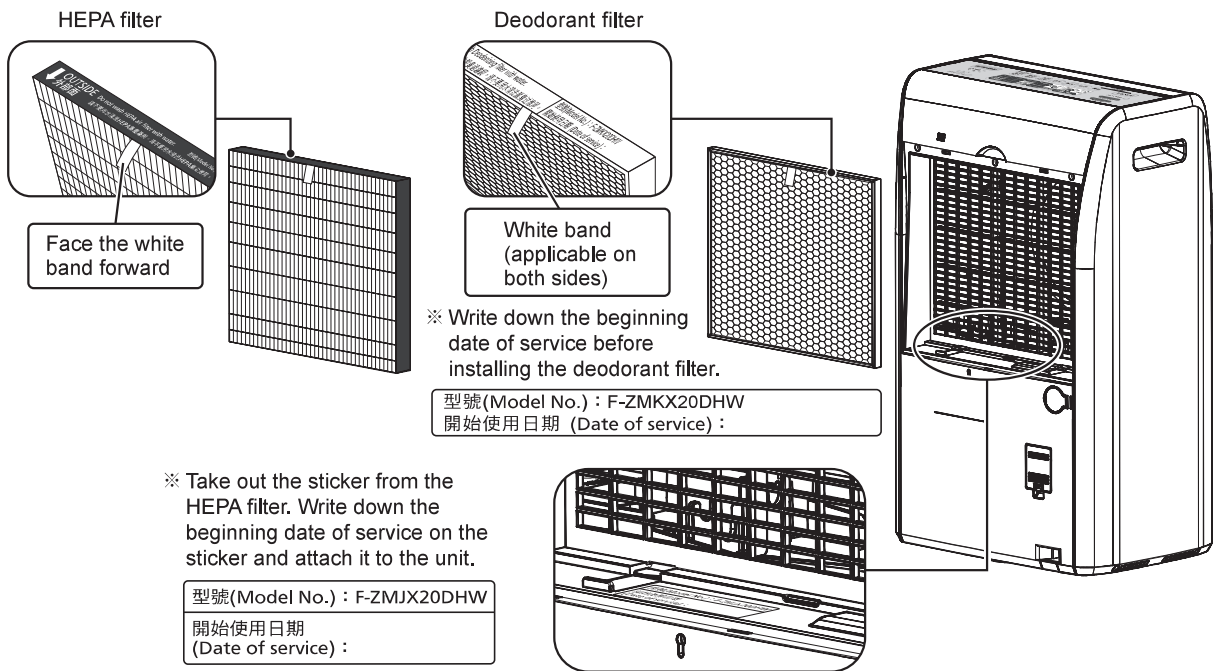

4 Install the air filter

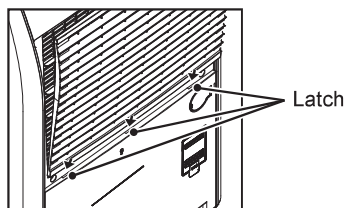

- ① Insert the three latches on the bottom of the filter into the holes on the unit.

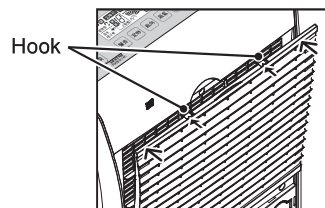

- ② Press the top of the filter down to engage the two hooks.

Parts Name

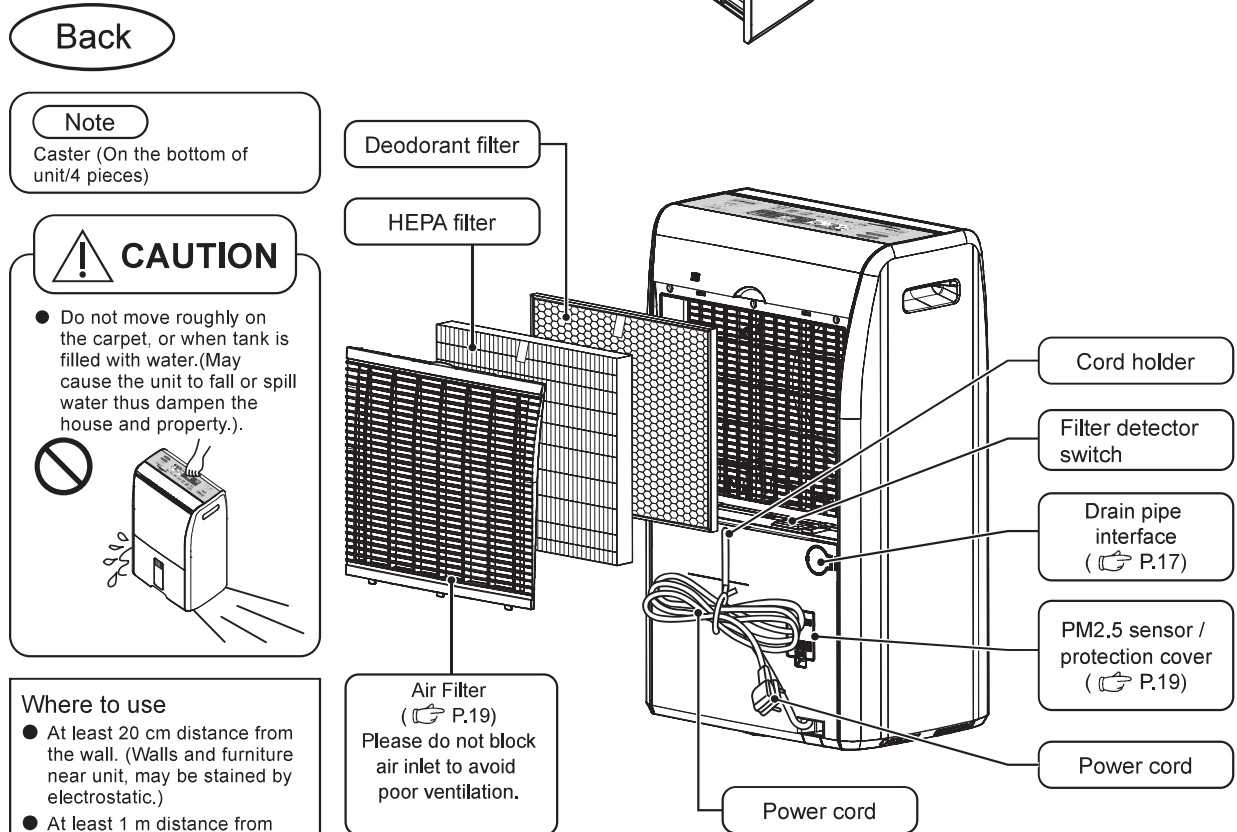
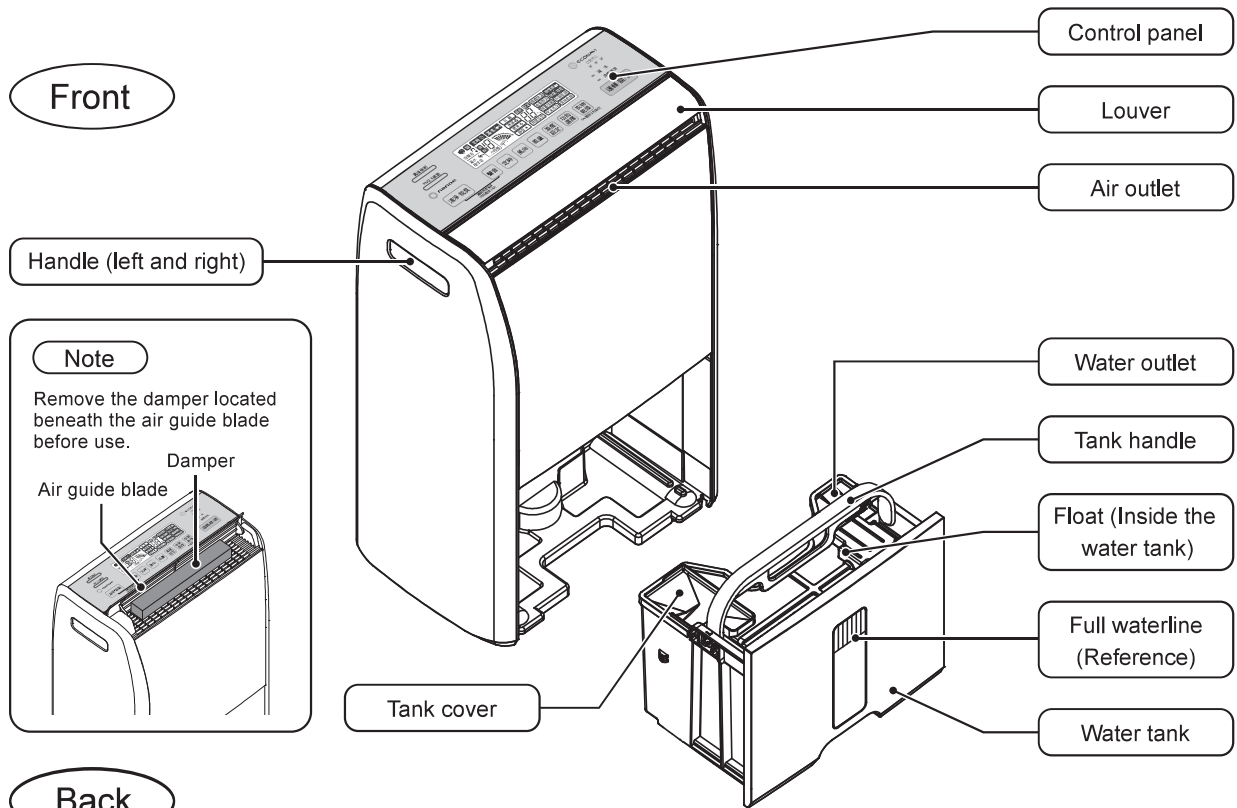

※ Remove bandage before use.

Control panel

Smell detection indicator (P.9)
 PM2.5 detection indicator (P.9)
 Water full display area (P.16)
 Function selection key / display area (P.10)
 Defrost / check display area (P.8)
 Auto stop indicator (P.12)
 Sound key / display area (P.15)
 Air volume key / display area (P.10)
 Key lock display area (P.15)
 ECONAVI Indicator (P.12)
 Drying indicator (P.12)
 Full Tank indicator (P.16)
 Clean, deodorization key (P.13) / nanoe™ indicator (P.12)
 Louver button / indicator (P.14)
 Cloth drying key / display area / key lock (P.12)
 Filter cleaning indicator (P.8)
 Timer button / display area (P.15)
 Humidity button / indicator (P.11)
 Power off / on button (P.10~P.12)

LCD indicator

Unpowered

When any key is pressed with the power turned on, the LCD backlight will light up and the selected function will be highlighted or displayed. If no key is pressed within 10 seconds, the backlight will go off automatically.

The LCD indicator turns orange for 10 seconds then goes off. The water **Full** display and indicator keeps on flashing. If the water full alert is ON, the buzzer beeps for 6 seconds together with the orange indicator.

Note

⚠ CAUTION

- Never use the dehumidifier when the unit is left unattended.
- Have the unit checked by professionals regularly.

Display of humidity

* It displays "Hi" if the humidity is higher than 85 % and display "Lo" if the humidity is less than 24 %.

Hi % Lo %

Check

* When the "Rep" indicator flashes and the error code "11" appears, please check the following:

- When unit is tipped over.
 - ① Unplug the power plug.
 - ② Set the unit back upright (wipe away any spilled water).
 - ③ Let the unit stand for half a day or more without using it. (to dry the unit inside completely in case any water has spilled inside)
 - ④ Insert the power plug again and restart the unit.
- Does the unit tilt?
 - Unplug the power plug and then reconnect it.

* If the "Rep" indicator stays on (without flashing), a problem occurs (as shown below).
Problem display

Case Rep + 01, 02, 13
02 % There are 13 error codes.

- Please shut down and unplug the unit immediately then contact your direct service center or dealer.

Full

* When the "Full" indicator and the water full display area flash, it indicates that the tank is full of water. All functions won't be able to work if the tank remains full.

Defrost

* When the "Defrost" indicator flashes, the defrost function is in operation.
→ Only the "Power off / on" key is operable.

Mildew prevention

※ **Power off mildew prevention:**

- * The unit may run 3 minutes in the fan mode to dry itself for mildew prevention after the operation ends (manual or timed power off). Press the "Power off/on" key when in this mode to cancel this function.
- * This function may not get enabled due to compressor operation time.

Protection

- To prevent the power from not being turned off, the unit will stop automatically if no key is pressed for 24 hours.
- If room temperature is higher than 32 °C, the air volume will increase automatically in order to protect the unit.
- Room temperature between 7 and 40 °C is suitable for operating the unit. Operation out of this range may cause some undesired problem.
- The unit will stop operation when power failure occurs, and return to standby mode after power recovery. To ensure compressor life, do not operate within 3 minutes after switching off the unit.

Filter cleaning

● The filter cleaning indicator will light up when the unit has run for over 500 hours, indicating that the filter needs to be cleaned. (See P.19)

By pressing Purifying
除湿·除菌 + Sound
静音 keys for 3 seconds simultaneously, you can reset the timer and the filter cleaning indicator.

* The filter cleaning indicator can be reset only with the power turned on. If the sound settings' on, you will hear a beep.

Comfort

● The dehumidifier is suitable for use in daily life, such as removal of unpleasant humidity and drying of laundries. However, if the ambient humidity is under 50 %, the unit will not be able to maintain an environment of comfortable humidity.

Factory default

● Standby

Press Louver
送风方向 and Humidity
湿度设定 simultaneously for about 7 seconds to activate the timer function. If "00" is displayed, the unit is reset to the factory default.

* After resetting to the factory default, all operating modes will be restored to their default settings.

Memory function

- When you stop and start the unit, it will return to the previous mode.
- If you disconnect and connect the plug again, the unit will return to the previous mode. (Except timed settings)

Air detector indicator

- The unit has to warm up at initial startup, the PM2.5 sensor and the odor detection will not be accurate in the first 3 minutes.

PM2.5 detection

- The PM2.5 table is provided in accordance with the PM2.5 index and health messages of the UK Daily Air Quality Index (DAQI).
- The index and health messages of the UK Daily Air Quality Index (DAQI) are for outdoor activities, while the unit is designed for indoor uses only.

Fine particulate matters (PM2.5) index and health messages

| Index | 1 | 2 | 3 | 4 | 5 | 6 | 7 | 8 | 9 | 10 |
|---|--------------------------------------|-------|-------|---|----------|----------|---|-------|-------|--|
| Air Pollution Banding | Low | Low | Low | Moderate | Moderate | Moderate | High | High | High | Very High |
| PM2.5 Concentration (pg/m3) | 0-11 | 12-23 | 24-35 | 36-41 | 42-47 | 48-53 | 54-58 | 59-64 | 65-70 | ≥71 |
| Accompanying health messages for the general population | Enjoy your usual outdoor activities. | | | Enjoy your usual outdoor activities. | | | Anyone who experiences eye pain, cough or sore throat should reduce outdoor activities. | | | Anyone who experiences eye pain, cough or sore throat should reduce strenuous physical activities, particularly outdoors. |
| Accompanying health messages for at-risk individuals | Enjoy your usual outdoor activities. | | | Adults and children with lung problems, cardiovascular disease and heart problems, who experience symptoms, should reduce strenuous physical activities, particularly outdoors. | | | 1. Adults and children with lung problems, cardiovascular disease and heart problems should reduce strenuous physical activities, particularly outdoors. 2. Older people should reduce physical exertion. 3. People with asthma may find the need to use their reliever inhaler more often. | | | 1. Adults and children with lung problems, cardiovascular disease and heart problems, as well as older people, should avoid strenuous physical activities, particularly outdoors. 2. People with asthma may find the need to use their reliever inhaler more often. |

Introduction of particulate matters (PM2.5) index

- (1) Particulate matters are the main factors that contribute to poor air quality in autumn and winter, i.e. the prevailing Northeast Monsoon seasons. In particular, fine particles whose diameter is less than 2.5µm can be a health hazard. For more information about the fine particulate matters (PM2.5) air quality index, please refer to the UK Daily Air Quality Index (DAQI).
 - (2) The index is divided into 10 levels and demonstrated with different colors as per the fine particulate matters (PM2.5) indicator of the UK Daily Air Quality Index (DAQI). For example, at-risk individuals should be careful with their outdoor activities and physical conditions when the PM2.5 concentration is up to 36µg/m3 (level 4), while the general population should reduce their outdoor activities when the concentration is up to 54µg/m3 (level 7).
- If the air quality detected by the PM2.5 sensor is good (the air quality index is 1-3 and the air pollution banding is "low"), the indicator lights in green.
 - If the air quality detected by the PM2.5 sensor is normal (the air quality index is 4-6 and the air pollution banding is "moderate"), the indicator lights in orange.
 - If the air quality detected by the PM2.5 sensor is poor (the air quality index is 7-9 and the air pollution banding is "high"), the indicator lights in red.
 - If the air quality detected by the PM2.5 sensor is heavily polluted (the air quality index is 10 and the air pollution banding is "very high"), the indicator lights in purple. (Only when the air volume selection is in the Auto mode can the above changes occur.)
 - The nanoe™ function will be activated automatically when the PM2.5 sensor indicator lights in purple, red or orange.

Odor detection

- The odor detection is an automatic inspection function. The odor detection indicator will change the display colors when the detector determines a poor air quality. (The colors of the odor detection indicator will change with the air volume only with the air volume selection is in the Auto mode.)
- The indicator lights in red when the odor level is high.
- The indicator lights in orange when the odor level is normal.
- The indicator lights in green when the odor level is low.
- The nanoe™ function will be activated automatically when the odor detection indicator lights in red and orange.
- The odor detection range: cigarette smoke, burning incense, cooking odors, pet smells, cosmetics, alcohol and mist sprays.

Operation mode / Air volume selection

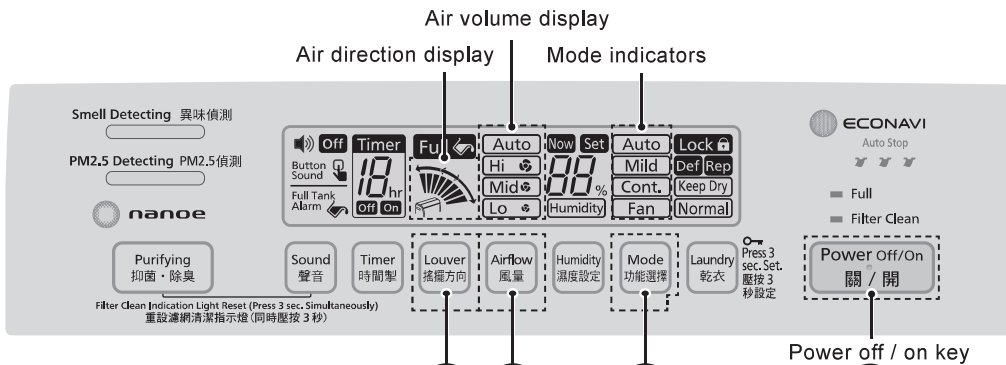

- 1 Insert the power plug
Turn on the unit



- The factory default settings of the dehumidifier is "Continuous dehumidification" and the air volume is "Auto".

- 2 Press to select



- 3 Air volume selection

- 4 Select the Air direction → P.14



To stop operation



- The product may run 3 minutes in fan mode after operation stopped to dry its internal side. (power off mildew prevention p.32)
- Please unplug the power plug at least 3 minutes after stopping the operation.

To use timed power on in the standby mode (P.15)



To use timed power off during operation (P.15)



When the Full Tank indicator is flashing (P.16)

- Operation will stop→Please empty the tank.

| | |
|--------------|---|
| Auto | To keep humidity at a comfortable level |
| | ● Humidity sensor detects the ambient level and keeps indoor humidity at the most suitable level for human body. However, the feeling of humidity varies from person to person; the "humidity setting" is available for adjusting the humidity if needed. |
| | ● The dehumidifier operates during high ambient humidity, and stops at low ambient humidity. |
| | ● Humidity level will be adjusted automatically according to the indoor temperature. |
| Mild | Maintain the humidity level (approximately at 65%) |
| Cont. | To force Continuous Dehumidifying (when humidity level cannot be controlled) |
| Fan | To clean and restrain bacteria (dehumidifying is stopped at this time) |
| | ● The unit adopts HEPA and deodorant filters to provide the effects of bacterial resistance, dust removal and deodorization. |

* When the filter is detected by the filter detector, the **Fan** will light up as you press down the Function selection key. If no filter is installed, the **Fan** will not light up when the Function selection key is pressed. The **Fan** will light up when only the air purifying function is in operation. The air velocity may vary depending on the use of the HEPA filter.

Air volume selection (Function selection / Humidity settings)

(Select the operation mode according to P10 - P12 before setting)

To change air volume

- The air volume can only be selected in the "Function selection" and "Humidity settings" modes.

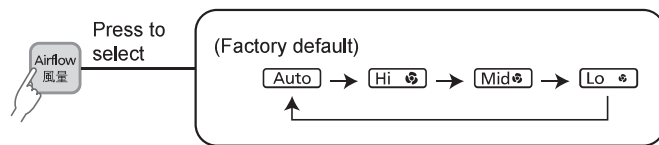

- Your product may enter protection mode with air volume and direction fixed from change in case room temperature goes above 32°C. (If you press the air volume and direction keys, the system will sound two beeps.)

To set humidity

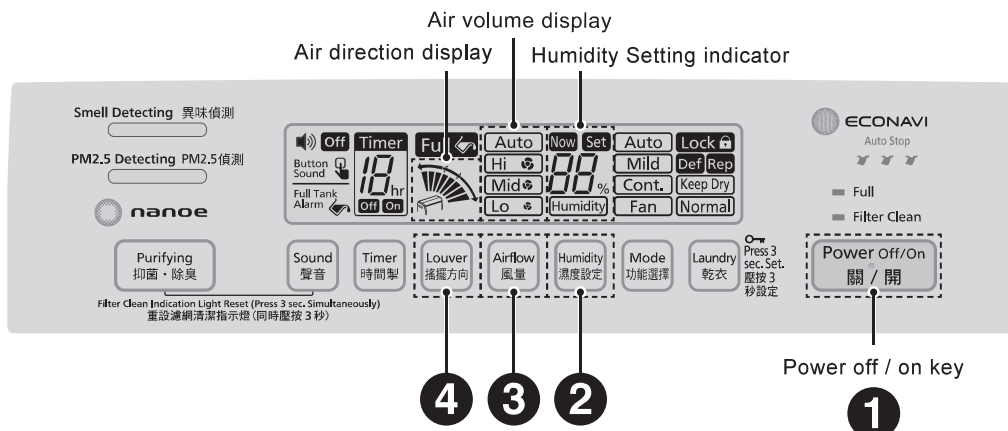

- 1** Insert the power plug
Turn on the unit



- 2** Press to select



- 3** Air volume selection → (P.10)



- 4** Select the Air direction → (P.14)

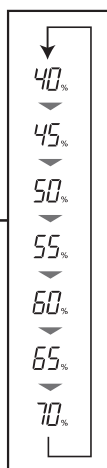

To set your desired humidity (the factory default is 40%)

- Press the "Humidity settings" key to set the desired ambient humidity. The system will prompt the set humidity value and the "Set" message for 5 seconds, and then display the current humidity value and the "Now" message again.
- Humidity sensor detects the ambient level and keeps indoor humidity at the set humidity.
- The dehumidifier operates during high ambient humidity, and stops at low ambient humidity.

■ When the Full Tank indicator is flashing (P.16)

- Operation will stop → Please empty the tank.

■ To stop operation



- The product may run 3 minutes in fan mode after operation stopped to dry its internal side. (Power off mildew prevention)
- Please unplug the power plug at least 3 minutes after stopping the operation.

■ To use timed power on in the standby mode (P.15)



■ To use timed power off during operation (P.15)



Laundry mode

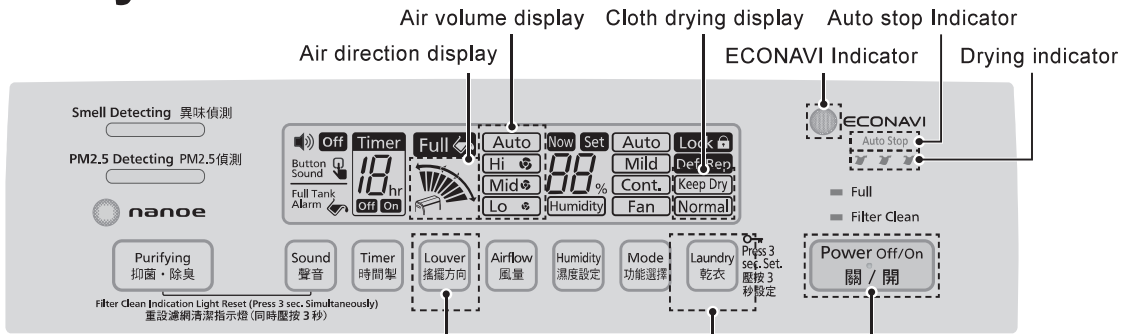

- 1 Insert the power plug
Turn on the unit

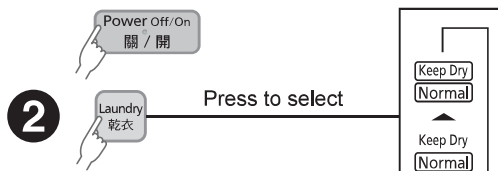

- 2 When the cloth drying function is activated, the air volume display will be fixed at the Auto mode. If you press the **Airflow** key at this time, the unit will beep.

- 3 Select the Air direction → P.14



To stop operation



- The product may run 3 minutes in fan mode after operation stopped to dry its internal side. (Power off mildew prevention)
- Please unplug the power plug at least 3 minutes after stopping the operation.

To use timed power on in the standby mode (P.15)



To use timed power off during operation (P.15)



- The ECONAVI Indicator, Auto Stop Indicator, Laundry Humidity Indicator will turn off in this mode.

When the Full Tank indicator is flashing (P.16)

- Operation will stop → Please empty the tank.

- 3
- 2
- 1

ECONAVI

- The ECONAVI Indicator, Auto Stop Indicator and Laundry Humidity Indicator will go on simultaneously during drying, and then go off after the drying process is completed.
- As the unit can detect the changes of temperature and humidity, it will operate in accordance with the quantity of laundry and the estimated drying conditions.
- For more information → refer to "About Cloth Drying Mode"

Auto + Normal

- After the completion of clothes drying and the Keep Dry + Normal indicators go off, the Humidity display of the Humidity settings will go on and the unit continues to run automatically.
- The ECONAVI Indicator and Auto Stop Indicator lights off and Laundry Humidity Indicator lights up in this mode.

Auto + Normal + Keep Dry

Intelligent dryness monitoring system (🌀 🌀 🌀)

- This function is valid for cloth drying.
- It tells drying status of cloths.

🌀 🌀 🌀 Laundry starts

↓

🌀 🌀 Approximately 1/3 dryness

↓

🌀 Approximately 2/3 dryness

↓

🌀 🌀 🌀 Laundry completed (※ Keep Dry operation)

(flash) ↓

🌀 🌀 🌀 Operation completed

※ After the drying process is completed, this can maintain the dry condition to keep the clothes dry.

- Based on type of laundry, quantity, and method of hanging, and room condition, etc, there may be variation of dry conditions.
- If the user is not satisfied with the dryness level, please select the [Keep Dry] function.

nanoe™ indicator

- To refresh clothes through the deodorization and sterilization process, the system will enable the nanoe™ function automatically when the drying process starts. (This cannot be canceled manually. If you press the "Purifying" key at this time, the system will beep.)

nanoe™ bacteriostasis and deodorization

nanoe™ (Cloth drying / Function selection / Humidity settings)

- To clean and deodorize during operation

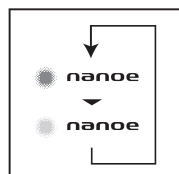

- When "Cloth drying"

To refresh clothes through the deodorization and sterilization process, the system will enable the nanoe™ function automatically. The LED indicator lights up and cannot be cleared manually. If you press the "Purifying" key at this time, the system will beep.

- In "function selection" and "humidity settings"

The nanoe™ function may be switched on/off as desired.

- When the installed HEPA filter is detected, the air purifying function is in operation and the Air pollution degree increases, the nanoe™ function will be activated automatically.

About nanoe™

Environment conditions for generation

- The nanoe™ is generated from indoor air which may fail to run successfully due to varying temperature and humidity conditions.
- Generation conditions
Indoor temperature: 5°C~35°C with dew temperature above 2°C.
Relative humidity: 30%~85%

Little amount of ozone

- The generation of nanoe™ ion may be accompanied with little amount of ozone. It's far less than ozone level existing in natural forest and bears virtually no impact on human body.
- In case of odor of ozone, disable the "cleaning and deodorization" function.

■ nanoe™

nanoe™ nano water ion (nanoe™ ion hereafter) is a charged clean water ion by separating water molecules with high voltage. The nanoe™ ion technology features sterilization★※1, allergens inhibition※2, fungi elimination※3 and deodorization※4 to deliver a space that's best for your beauty skin.

★ 〈Floating fungi〉 : the result is achieved from a 4-hour test in a 25m³ closed space instead of practical use.

★ 〈Adhering fungi〉 : the result is achieved from a 8-hour test in a 23m³ closed space instead of practical use.

Deodorization effects vary with ambient environment (temperature, humidity), operation hours, deodorization, type of fabrics.

- Standalone test and practical use effect may differ from each other due to room conditions and use method.
- This device is not a medical equipment.

※1 〈Floating fungi〉

- Experimental organization: Foundation Kitasato Environmental Science Center
- Experimental method: place directly in a 25m³ lab to determine the amount of collected bacteria
- Sterilization method: releasing nano water ion
- Subjects: Floating fungi
- Results: more than 99% floating fungi killed after 4 hours "BSHF 24_0301_1"

〈Floating fungi〉

- Experimental organization: Foundation Kitasato Environmental Science Center
- Experimental method: determine the amount of bacteria adhere to the standard cloths in the 23m³ lab
- Sterilization method: releasing nano water ion
- Subjects: bacteria adhere to standard cloths
- Results: more than 99.9% bacteria adhere to standard cloths killed after 8 hours "No. 13044083003-01"

※2 ● Experiment institution: Matsushita Electric Works Analysis Center (Corporation)

- Experimental method: place directly in a 23m³ lab and test by the ELISA method
- Removal method: releasing nano water ion
- Subjects: pollen (cedar)
- Results: more than 88% allergic substance inhibited in 8 hours "BAA33-130402-F01"

※3 ● Experiment institution: Japan Food Research Laboratories

- Experimental method: measure the changes in the amount of fungi in a 23m³ lab
- Sterilization method: releasing nano water ion
- Subjects: planktonic fungi
- Results: check the effect after 8 hours "No. 13044083002-01"

※4 ● Experiment institution: Matsushita Electric Works Analysis Center (Corporation)

- Experimental method: verify with the 6-grade odor intensity table in a 23m³ lab
- Deodorization method: releasing nano water ion
- Subjects: adhering cigarette odor
- Results: odor intensity dropped to grade 1.2 in 2 hours "BAA33-130125-D01".

Note: The nanoe™ and nanoe™ logo is trademark of Matsushita Electric Industrial Co., Ltd.

Air direction selection

Operations of the air direction selection (Cloth drying / Function selection / Humidity settings)

In accordance with the height range that you want to blow the air.

■ To change the air direction

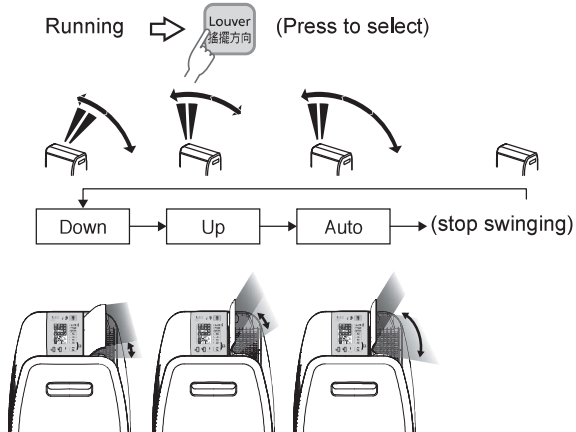

■ Fix louver

When selecting "Auto", the louver will swing automatically. When it reaches to the desired location, press the  key again.

- The swing direction indicator will go off. The louver stops swinging and starts blowing in the fixed direction.





Note

- Do not move the air guide blade with your hands when it's swinging. (Or the swinging range may change)
- In this case, reset the air direction in accordance with the operations of the air direction selection or restart the unit. The angle will become normal.

Setting examples of the air direction

Tips for fast clothes drying

- 1 Blow the air from the dehumidifier directly and completely to the clothes.
- 2 Leave spaces between each cloth to circulate the air.
- 3 Maintain a distance of at least 40cm between the dehumidifier and clothes.

| | | | |
|--------------|-------------------------------|----------|---|
| Cloth drying | Low hanging position | Down |  |
| | High hanging position | Up |  |
| | High and low hanging position | Auto |  |
| | Fewer clothes | Auto * 1 |  |

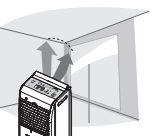
| | | | |
|-----------------------|-------------------------|----------|---|
| Dehumidification mode | Wardrobe / shoe cabinet | Auto * 1 |  |
| | Ceiling / walls | Up |  |

* 1: Switch between "Up" and "Down" depending on the hanging position and height of the wardrobe.

- Based on type of laundry, quantity, and method of hanging, and room condition, etc, there may be variation of dry conditions.
- DO NOT dry leather goods, e.g. shoes, with the dehumidifier. (This may lead to deformation or deterioration.)

Timer / sound / key lock settings

To use timed power on in the standby mode

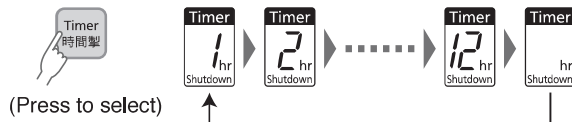

- When the **Timer** key is pressed in the standby mode, the LCD display will go on ^{Note 1}. After settings is completed, press the **Power Off/On** key to finish the "timed power on" settings. If you want to cancel the timed settings, press the **Power Off/On** key again.
- If you do not set any settings in the "timed power on settings" mode, the settings on the display and the LCD backlight will turn off after 10 seconds and return to the previous state.
- The timer displays the remaining time once it is set. For example, if the timer is set to "9 hours" and with 8 hours to go, it displays "8 hours".

Note 1: Enter the "timed power on settings" mode. The settings will either be the factory default or the previous settings.

To use timed power off during operation

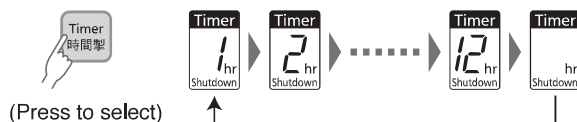

- Press the **Timer** key when the power is on.
- The timer displays the remaining time once it is set. For example, if the timer is set to "9 hours" and with 8 hours to go, it displays "8 hours".
- The time will keep counting down once the timed power off is set, even if the unit stops due to the full water tank.
- If you set the timed power off in the clothes drying mode, the ECONAVI Indicator, Auto Stop Indicator and Drying Indicator will not display.

Sound settings



Key lock setting

- Activate the key lock
Press and hold the **laundry** key for about 3 seconds in the standby mode or in operation to activate the key lock. The LCD **Lock** will light up. All functions won't be available at this time. (If you press any key when the key lock is activated, the backlight will go on.)
- Unlock the key lock
Press and hold the **laundry** key for about 3 seconds in the standby mode or in operation to unlock the key lock. The LCD **Lock** will go off. You can now operate any key.
★ Key Lock will be automatically unlocked when power failure occurs. You should reset the key lock before you activate it.
★ The key lock function cannot be canceled by pressing the key until the full tank is drained.

Handling of a fallen air guide blade / full water tank

Handling of a fallen air guide blade

When the air guide blade falls off

■ Air guide blade installation

- 1 Point and insert holes to the left to thud at left side of your product.
- 2 The air guide blade is flat and slightly bent at its center part.
- 3 Insert right hand side of it to machine body.

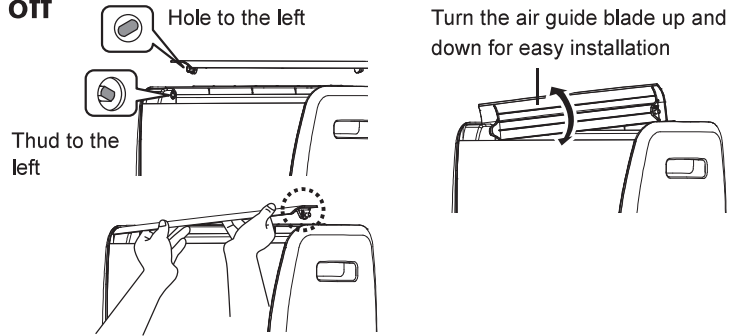

Dealing with filled up water tank

- The product stops operation automatically when water in tanks reaches the full level (about 4.8 liter). The LCD will light in orange for about 10 seconds and go off when the tank becomes full. The water **Full** display area and the full tank indicator keep on flashing. (When the full tank alarm is set to ON, the unit will utter beep ..beep..beep..sound for about 6 seconds with the orange light on.)

- Please empty water tank as described below

- 1 Hold the unit body steady with one hand and gently pull the water tank out with the other.
 - Do not touch the inner body of the unit. (Risk of failure)

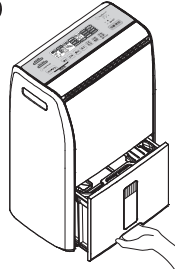

- 2 Move water tank handle to drainage position.

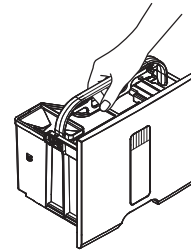

- 3 Press and hold water tank cover to open the drainage opening.

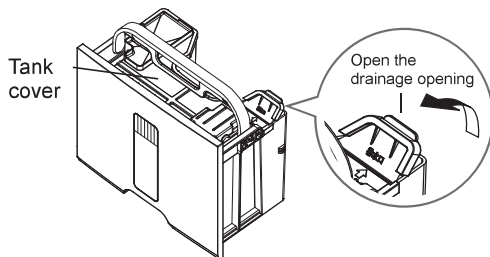

- 4 Hold water tank handle and its bottom to drain it.

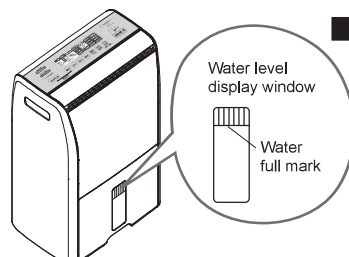
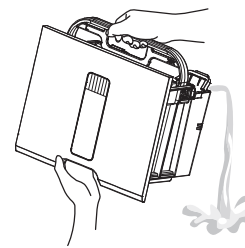

■ Water tank installation

Close the drainage opening, insert water tank into place

- Close both water tank cover and drainage opening for installation. (or the water tank may fail to install into place and may lead to water leak)
- Push water tank into place. In case of damaged poorly installed water tank the water full indicator may fail to flash and system operation may fail to start. Please remove the water tank and install again.

How to drain continuously

- You may connect a hose to this product for continuous drainage if applicable.
(Call your direct service center or dealer for continuous drainage installation or removal).

CAUTION

- Secure drainage hose firmly.



Keep drainage hose from bending and elevation difference for good drainage. Poor drainage may lead to water leak and wet floor.

- Keep temperature around the drainage hoses above zero Celsius.



Or water in drainage hose may get frozen. This may block the hose from drainage and lead to water leak and wet floor.

Drainage hose installation

Valid installation

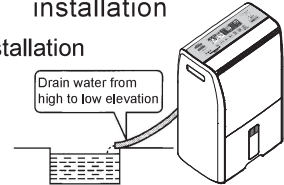

Invalid installation

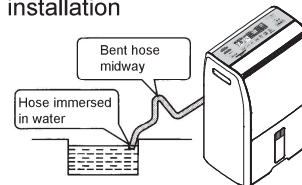

Required accessories

- Commercially available plastic water hose
- Length: 30cm longer than distance from dehumidifier to drainage opening
- Inner diameter: 15mm

Note

Temperature difference in between water in drainage hose and environment may lead to water condensed on surface of drainage hose. Take insulation measures if necessary.

1 Remove power plug and water tank

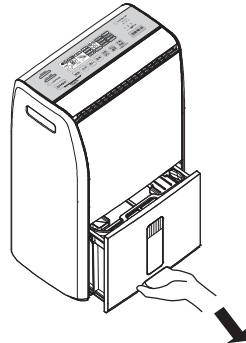
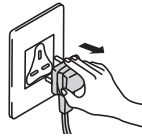

2 Open up drainage hose holder (turn it 90 degree outward instead of removing it)

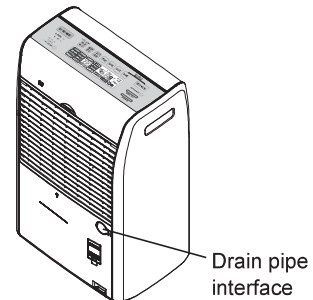

3 Remove water blocker

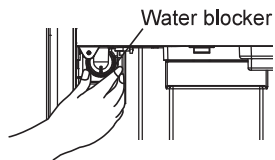

Hold it in the direction of arrow ① and remove it in the direction of arrow ②.

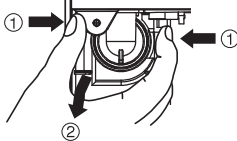

4 Install drainage hose

Insert one end of drainage hose in drainage elbow.

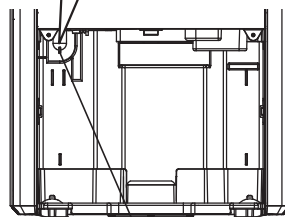

Drainage elbow

5 Install water tank

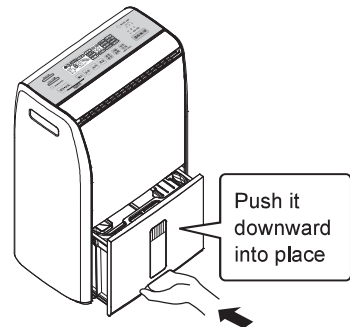

- Invalid installation may lead to operation failure

Note: please call your direct service center or dealer to un-install it as invalid installation may lead to water leak out of the water tank.

Maintenance



Empty the water tank before doing any maintenance work!

- Please disconnect the power plug and empty the tank. (how to drain the tank)



- DO NOT use detergent listed to the left (they may deteriorate, decolor, or damage plastic components)
- Before using any chemical rag read its instructions carefully.

water tank: once per month

- Wash the water tank and tank cover with clean water 2 - 3 times.
- You don't need to remove the float, just clean it with water.

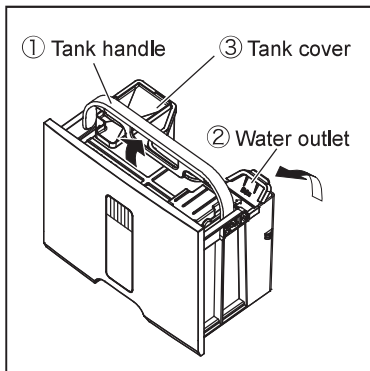

- To remove the tank cover
 - ① Turn water tank handle up
 - ② Open the water outlet
 - ③ Pull water tank cover upward
- DO NOT pull water outlet with brutal force

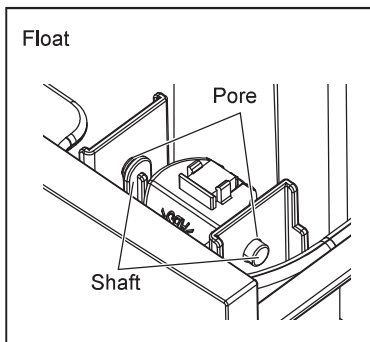
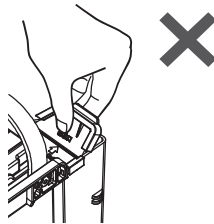

- Float
 - Clean dirt around shaft with water (to prevent float from malfunctions)
 - DO NOT remove float (invalid installation of it may lead to operation failure and water leak)
 - Insert both axis in hole as illustrated in figure to the left when float falls off.

- Remove sticky dirt with thinned neutral detergent.
- Inner wall of tank may get black (due to dirt in air dissolved in water).

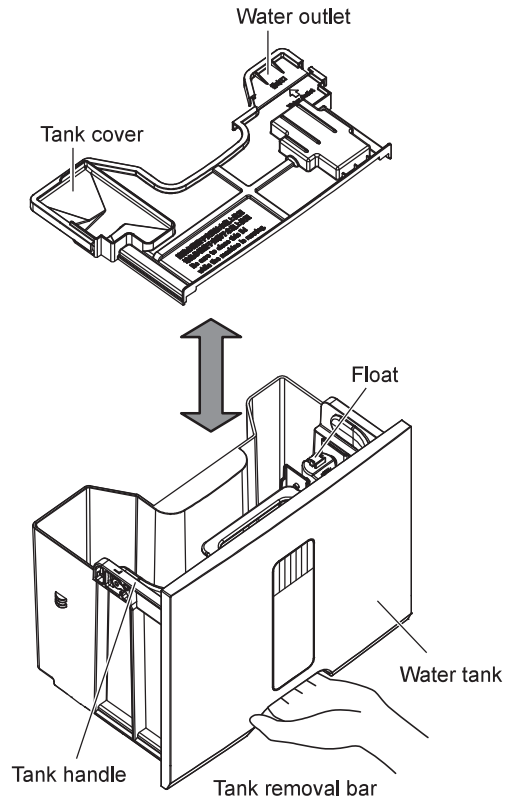

- Please disconnect the power plug before servicing.
- Wipe the unit body with a wrung cloth and wipe with a dry cloth again.
 - Do not lay the unit down or place on its side. (this may lead to water leak)
 - Remove sticky dirt with thinned neutral detergent. Place it in the shade and dry it completely.

HEPA filter
(When the filter cleaning indicator goes on)

Remove dirt from the black side (front side) with a vacuum cleaner.
(For installation and removal information→refer to P.29) Brush nozzle or crevice nozzle

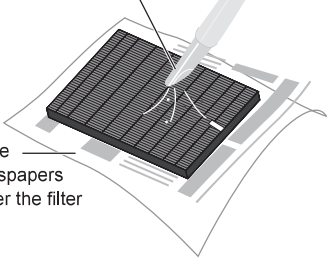

Place newspapers under the filter

- The filter is fragile. Do not press down the filter with force while vacuuming.
- The white side (back side) is free of maintenance.
- Do not wash with water.

- The deodorant filter is free of maintenance.

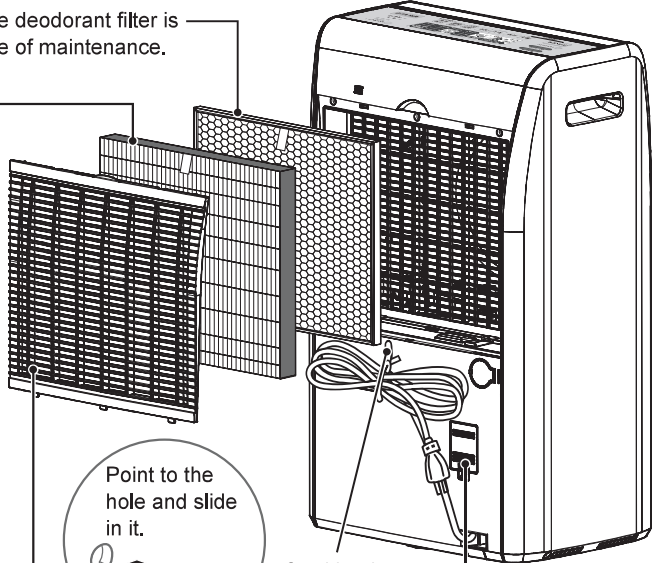

Point to the hole and slide in it.

Cord holder

- Insert power cord tie strip

Air Filter (It is recommended to do so once every two weeks)

Remove dirt with vacuum cleaner
(For installation and removal information→ refer to P.29)

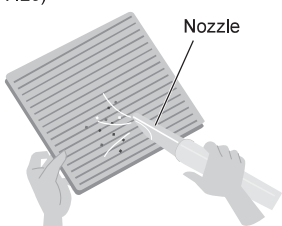

Nozzle

- Replace in case of any damage.
- Regular maintenance (If the filter is dirty or clogged, the dehumidification capacity may drop, electricity consumption increase and failures may occur).

PM2.5 sensor (approx. 1 time/500 hrs)

Remove dirt on the lens with dry cotton swabs.

- Clean the lens regularly.
(If the lens is contaminated by dampness and cigarette smoke and oil mist, the sensor may operate incorrectly).

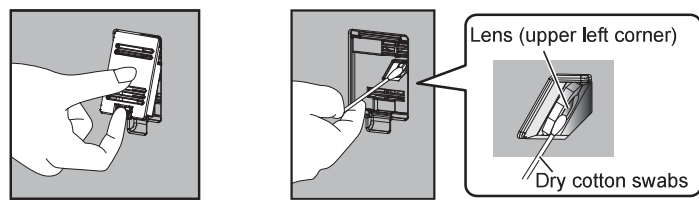

- ① Remove the PM2.5 sensor protection cover.
- ② Use dry cotton swabs shown in the figure to wipe.



Lens (upper left corner)

Dry cotton swabs

- Use a flashlight if lighting is poor.
- Do not insert dry cotton swabs into any place other than the lens.
- Please disconnect the plug before you start the work.

- You can reset the timer and the filter cleaning indicator after cleaning or filter replacement by pressing  +  keys for 3 seconds simultaneously while the unit's running.

Recommended Frequency of Filter Replacement

| Model No. | Recommended replacement frequency | Requirements |
|------------------|-----------------------------------|--|
| HEPA filter | Approx. 1 time/3 yrs | When 5 cigarettes are smoked daily (the indication for exchange of filter) (Japan Electrical Manufacturers' Association standards JEM1467) |
| Deodorant filter | Approx. 1 time/5 yrs | |

- ※ Filter replacement frequency may be shorter than normal, depending on the environment and usage. (Optional parts: P.23)
(For example, in household where smoking is frequent.) Please replace it when the performance is decreased.
- Write down the beginning date of service before installing the deodorant filter. Write down the beginning date of service on the sticker and attach it to the unit when replacing the HEPA filter.
- The used deodorant filter should be disposed as a non-flammable waste.

For machine not to use for long time

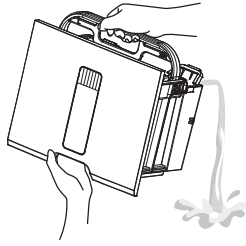

- ① To dry the remaining moisture in the inner body of the unit and decrease mold propagation, please operate the unit in the FAN mode and set the timed power off for about 1 hour.
- ② Remove the power plug. Leave it for a day and drain the water tank (P.16).
- ③ Clean the unit body, water tank and filters.
- ④ Cover the unit body with a plastic bag.
- ⑤ Store the dehumidifier in a place of low humidity, good ventilation and flat surface. (leave it tilted may lead to failure and water leak)

About Laundry mode

■ About ECONAVI

When selecting "cloth drying", the air volume will be fixed at the Auto mode. The ECONAVI Indicator, Auto Stop Indicator and Dry Indicator will light up at the same time and turn off after the drying process is completed.

As the unit can detect the changes of temperature and humidity, it will operate in accordance with the quantity of laundry and the estimated drying conditions or auto stops.

- Reference operation hours before auto stop (Unit: Hour).

| Model No. | F-YAP21H |
|-------------------------|----------------------------------|
| Volume of cloths | Working hours for "Cloth drying" |
| 2kg - 4kg approximately | 5.3~6.7 |
| 4kg - 6kg approximately | 6.7~9.2 |

Test conditions: temperature at 20°C;
 humidity at 80%, room size of
 approximately 18.18 square
 meters. (results as tested by this
 company)

- Actual operation time, power consumption, dehumidification level may vary with conditions of environment, type, amount, hanging pattern of cloths, room size.

- If you want to dry clothes with the dehumidifier, it's recommended to do it in a small (smaller than 18.18 square meters) and well-closed space for less energy waste. Operation stops after about 10 hours.

Fault

Please check the following first.

If the problem persists after all these steps are taken, disconnect the power plug and call your direct dealer or service center.

| Error | Please ensure its contents |
|---|---|
| ① Key operation failed | <ul style="list-style-type: none"> ● Water full indicator flashes (P.16), Check indicator flashes? (P.8), Key lock settings (P.15) |
| ② Water full indicator flashes while the tank is not so | <ul style="list-style-type: none"> ● Is water tank or float installed successfully? (P.16, P.17, P.18) ● Is water tank get hit during its installation? (P.16) →remove water tank and install it again. |
| ③ Water leaks | <ul style="list-style-type: none"> ● Is the unit body tilted or flipped over? ● Is water left in the tank when moving the unit body? (P.4) ● Is float falling off? (P.18) |
| ④ Few waters kept in tank (low dehumidification volume) | <ul style="list-style-type: none"> ● Is filter clogged? (P.19) Is the air inlet or outlet clogged? (P.4) ● Is indoor temperature or humidity too low? (lower temperature or humidity may lead to less dehumidification volume.) ● Is the auto dehumidification mode in the Function selection selected? (P.10) ● If the temperature is out of the range of 7°C - 40°C, the blower motor will start operating instead of the compressor. (P.8) |
| ⑤ No water condensed in tank | <ul style="list-style-type: none"> ● Is the air purifying function in use? →Water will not condense in the tank when using the air purifying function. |
| ⑥ It takes a long time to dry the clothes | <ul style="list-style-type: none"> ● Is wet and cold air getting into room? → use the system in closed door if possible. |
| ⑦ Poor cloth drying effect | <ul style="list-style-type: none"> ● Are you drying without fully dewatering? ● Is wet and cold air getting into room? → use the system in closed door if possible. ● Are you using it close to electric heater? (rising temperature close to internal sensor may hamper the system from determining drying time correctly.) ● Is air blowing covering all dresses? ● Are dresses drying in stacked, poorly spaced apart conditions? |
| ⑧ Humidity remains high | <ul style="list-style-type: none"> ● Is wet and cold air getting into room? → use the system in closed door if possible. ● Is there other steam release equipment exists indoor? |
| ⑨ Dehumidification continues while condensation remains | <ul style="list-style-type: none"> ● Location of poor ventilation, e.g. windows exposed to external air or inner side of the furniture, may result in low dehumidifying effect. |
| ⑩ Rep indicator flashes with error code [11] displays. | <ul style="list-style-type: none"> ● Is the unit body tilted? → 1. Disconnect the plug, lift the unit body straight up and wipe off any spilled water 2. Leave the unit for half a day or more without using it. (to dry the unit inside completely in case any water has spilled inside) 3. Insert the power plug again and restart the unit. ● Is the unit body tilted too much? → Unplug the power plug and then reconnect it. |
| ⑪ There is hiss, squeak, or water flow sound heard | <ul style="list-style-type: none"> ● This is the sound of the refrigerant flowing inside the dehumidifier or nanoe™ ion generation. It's not a failure. |
| ⑫ The odor detection indicator stays on in "red" even if the unit operates continuously | <ul style="list-style-type: none"> ● The indicator may light in red under the influence of hot steam from a bathroom or gases generated when using sprays. |

Fault

Please check the following first.

If the problem persists after all these steps are taken, disconnect the power plug and call your direct dealer or service center.

| Error | Please ensure its contents |
|--|--|
| ⑬ The PM2.5 detection indicator stays on in "purple" even if the unit operates continuously | <ul style="list-style-type: none"> ● Is the PM2.5 sensor dirty? (P.19) |
| ⑭ The air is dirty but the PM2.5 detection indicator still lights in "green" | <ul style="list-style-type: none"> ● Please confirm whether it's in a place that dirt is hard to collect. ● Is the PM2.5 sensor dirty? (P.19) ● When the operation mode and air volume change, the PM2.5 sensor may take a longer time to detect. |
| ⑮ Air pollutants are hard to remove | <ul style="list-style-type: none"> ● Is the HEPA filter dirty? (P.19) →If the problem still exist after the maintenance work, replace the filter with a new one. |
| ⑯ Low air volume | <ul style="list-style-type: none"> ● Is the HEPA filter dirty? (P.19) →If the problem still exist after the maintenance work, replace the filter with a new one. |
| ⑰ Unpleasant odor makes people feeling ill | <ul style="list-style-type: none"> ● Is the HEPA filter dirty? (P.19) Is the deodorant filter ineffective? (P.19) →If the problem still exist after the maintenance work, replace the filter with a new one. (The unit is not intended to remove carbon monoxide and hazardous substances generated from cigarettes.) ● Do you use the dehumidifier in rooms with strong odor? If the dehumidifier is used in an environment full of cigarette or barbecue smoke, the filters should be replaced at a shorter interval. →If the unit is used in such environments, we recommended that you turn on the air exchange system of the room at the same time. |

In case of the following, disconnect the power plug and contact your direct service center or dealer.

| Error | Please ensure its contents |
|--|--|
| ⑱ The "Check" indicator stays on (without flashing) and prompts the error code (P.8 Check) | <ul style="list-style-type: none"> ● If it's a unit body failure, please note down the error code and contact your direct service center or dealer. |

Emergency measures

In case of the following situations, please shut down and unplug the unit immediately and contact your direct service center or dealer.

- Poor switch operation.
- Leak switch or fuse cutout frequently.
- Power cord and plug over heated.
- Odor or noise during operation.
- Water leaks from host.
- Other error or failure.

Please observe the rule

For your safety, if the power cord of this dehumidifier is damaged, have your direct service center or dealer replace it.

Optional parts

| | |
|------------|-------------------------|
| Parts name | Replacement HEPA filter |
| Model No. | F-ZMJX20DHW |

| | |
|------------|------------------------------|
| Parts name | Replacement deodorant filter |
| Model No. | F-ZMKX20DHW |

Dehumidifier inspection for continuous use!

Does the symptom exist?

- The unit dose not run or stop in operation abruptly after the power is on.
- The power cord does not work appropriately when it's moved.
- An abnormal noise or vibration occurs when the fan blade is rotating.
- The unit body emits excessive heat and a burning smell.
- Other abnormalities or faults.



In case of any of these symptom, please turn the power off and disconnect the plug to avoid accidents. Contact your direct service center and dealer.

Specifications

| | | | |
|-----------------------------------|-------------------|---|-------|
| Model No. | | F-YAP21H | |
| Power supply | | 220 V~ 50 Hz | |
| Power plug shape | |  | |
| Operating condition | Temperature | 26.7 °C | 30 °C |
| | Relative humidity | 60 % | 80 % |
| Dehumidification capacity (L/Day) | | 12.2 | 21 |
| Power consumption (W) | | 228 | 265 |
| Water tank capacity (L) | | The unit automatically stops at around 4.8 litres | |
| Weight (kg) | | 15.0 | |
| Dimensions (W X H X D) (mm) | | 370 X 605 X 250 | |

- Power consumption by dehumidifier at standby mode: 0.8W. (with power plug connected)

Customer's record

For model name and production number of this product, please refer to the back side of machine.
Please record them in the space provided and keep for future reference.

| | |
|------------------|---------------|
| Model No. | SERIAL NO. |
| DATE OF PURCHASE | DEALER'S NAME |
| DEALER'S ADDRESS | |
| TELEPHONE NUMBER | |

Panasonic Corporation

Web Site : <http://panasonic.net/>

©Panasonic Ecology Systems Co., Ltd. 2017

C8041-2670
2017.11