

Panasonic®

使用說明書

電風扇

Operating Instructions

Electric Fan

型號 / Model No.

F-25UGA



非常感謝你購買此 Panasonic 產品。

使用本產品前，請詳細閱讀本說明書，並保留作日後參考之用。
使用前，請務必先閱讀「安全注意事項」(第 2-4 頁)。

本產品只可在室內使用

目錄

安全注意事項	2-4
• 使用要求	
各部件名稱	8-9
使用方法	10-11
• 開/關	
• 風速	
• 1/f Yuragi	
• 關機定時器	
保養	12-13
排解疑難	14
規格	15

Thank you very much for purchasing this Panasonic product.

Before operating this product, please read the instructions carefully, and save this manual for future use.

Also, be sure to read the "Safety precautions" section (P.5 to 7) before use.

This product is for indoor use only.

Contents

Safety precautions	5-7
• Operating conditions	
Name of parts	8-9
How to use	10-11
• Off/On	
• Wind speed	
• 1/f Yuragi	
• Off timer	
Cleaning	12-13
Troubleshooting	14
Specifications	15

為避免引致使用者受傷或財物損壞的可能性，請務必遵守下列注意事項。

• 以下標誌是根據錯誤使用所產生的危險或受傷程度而分類。

 警告	表示如不遵守該指示，可能造成死亡或嚴重受傷。
--	------------------------

 注意	表示如不遵守該指示，可能造成人身傷害或物品損壞。
--	--------------------------

• 以下標誌為需要遵守的指示種類。(下列標誌為例子。)

 此標誌表示為禁止事項。
--

 此標誌表示為強制事項。

 此標誌表示為必須小心進行的事項。

 警告
--

 不要令 AC 配接器的電線或插頭受損。 (切勿裁剪或改造。切勿強行折曲、扭曲或拉扯。切勿放在發熱器具附近或負重。切勿捆成一札。) 使用損壞的電源線或插頭，可能引致短路等，並造成觸電或火災。 ● 請聯絡經銷商維修電源線或插頭。 如果電源線已損壞，必須找製造商、服務代理商或合資格人士更換，以免發生危險。

 請勿使用超過額定功率的電插座或配線器材。不要將本產品連接至額定電壓及額定頻率以外的電源。 如使用電源延長線等超過額定功率，可能引致發熱，造成火災。
--

 手濕時不要連接或拔除 AC 配接器。 此舉可能引致觸電。

 請勿在風扇運行時拉緊 AC 配接器的電線。 此舉可能令電源線損壞，引致短路並造成觸電或火災。



 不要將本產品放置在 AC 配接器的電線上。
--

此舉可能令電源線損壞，引致短路並造成觸電或火災。





 移動本產品時請勿拉扯 AC 配接器的電線。
--

此舉可能令電源線損壞，引致短路並造成觸電或火災。

 不要將 AC 配接器的電線纏繞在機身或架子上。
--

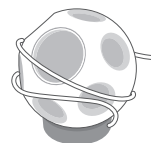
此舉可能令電源線損壞，引致短路並造成觸電或火災。



 出現故障時，立即停止使用本產品，並從電源上拔除 AC 配接器。
--

否則可能引致發熱，造成觸電或火災。

[故障/失靈例子]

- 即使開啟電源後都不運行。
- 運行時發出異常聲音。
- 移動電源線時停止運行。
- 發出焦味。
- AC 配接器或電線異常地熱。
- 請立即聯絡經銷商進行保養/維修。

 確保 AC 配接器的電源插頭已經完全插入插座內。

如插頭鬆脫未插好，可能會引致觸電或插頭過熱而造成火災。

- 請勿使用已損壞的插頭或鬆脫的插座。

 只應使用隨附的 AC 配接器。
--

不遵守指示可導致觸電或火災。

 定期抹去 AC 配接器電源插頭上的塵埃。

如電源插頭上積聚了灰塵，潮濕的空氣等可能引致絕緣不良而起火。

- 拔除 AC 配接器，然後用乾布擦拭。
- 長期不使用時，拔除 AC 配接器。

**只應使用隨附的架子。**

如不使用架子，或使用了其他代替品，機身可能會跌下，引致受傷。

**即使不使用時，亦必須放在隨附的架子上面。**

機身可能會跌下，引致受傷。

**不要將金屬物件等異物放在出風口或進風口的罅隙。**

異物接觸到內部零件可能引致觸電或短路等情況而發生火災。

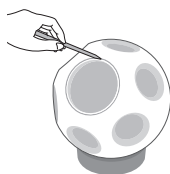
**切勿擅自拆散、修理或改造本產品。**

可能著火或運行異常，引致觸電、火災或受傷。

● 本產品故障時，請聯絡經銷商修理。

**請勿把本產品浸於水中或沾水。**

可能引致短路並造成觸電或火災。

**不要放在可能會被寵物等動物的尿射到的地方。**

可能引致短路並造成觸電或火災。

**請勿把本產品放置在發熱電器旁邊。**

塑膠部件可能溶化而起火。

**不要放在高處。**

機身可能會跌下，引致受傷。

**注意****切勿在以下場所使用本產品：**

■ 接近易燃氣體或火源如爐具等場所。

■ 暴露於雨點或水的場所。

■ 高溫、潮濕、多塵的地方。

(溫室、塑料大棚、廠房等)

可能引致熄火、中毒、起火、爆炸、短路等，並造成觸電或火災。

**不要將本產品置於使用殺蟲劑、油類或化學品的地方附近。**

■ 工廠等使用化學品的地方。

■ 使用芳香或香薰油開展經營活動的地方。

• 可能會發生塑料零件的劣化，導致產品破損，使得產品墜落並造成人員受傷。

• 此舉可能令電源線損壞，引致短路並造成觸電或著火。

**不要將本產品放在可能使人絆倒的地方。**

若被絆倒可引致受傷。

**放在水平且穩當的場所。**

若放在不穩當的地方，產品可能會跌落，引致受傷。

**清潔本產品時，確保拔除 AC 配接器。**

否則本產品可能會無預期地開始運作，引致受傷或觸電。

**不要拿著 AC 配接器的電源線晃動或移動架子。**

• 此舉可能令電源線損壞，引致短路並造成觸電或著火。

• 架子可能會脫落，引致受傷。

**拔除 AC 配接器時，握住 AC 配接器並將它拉出，而不是拉電線。**

此舉可能令電源線損壞，引致短路並造成觸電或著火。

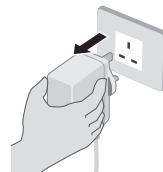

⚠ 注意

- ⊘ 不要站在或坐在機身上。
此舉可引致受傷。
- ⊘ 不要拋擲、踢或滾動機身以作遊玩。
機身可能會撞到人，引致受傷。
請特別留意小孩或寵物。
• 本產品並非玩具。
- ⊘ 不要吊著機身使用。
機身可能會跌下，引致受傷。
- ⊘ 當本產品放在架子上時，請勿拖動它。
它可能會損壞桌子或地板，或可能導致本產品從架子上掉落。
- ⚠ 搬動時拿著機身下方。
若拿著導引出風口或導引進風口，機身可能會跌下，引致受傷。
• 請由機身拔除 AC 配接器後才搬動。

- ⊘ 不要將手、腳或頭放入架子或機身的導引出風口或導引進風口。
可能會無法拔出，引致受傷。
- ⊘ 請勿讓身體對著本產品長時間吹風。
這可能會導致與健康有關的問題。
- ⊘ 不要使本產品產生的風朝向加熱器具。
可能引致熄火、中毒、起火、爆炸等。

- ⚠ 以下人士使用本產品時，應特別留意。
(幼兒、老人或不能自行調節體溫者)
讓身體對著本產品長時間吹風，可能會令他們感到不適或脫水。

使用要求

- 不要將本產品置於出風口、進風口、導引出風口或導引進風口被窗簾等阻擋的地方。
(可引致本產品性能下降)
- 將本產品放置在離開電視機、收音機或其他影音器材 1 m 以上的地方使用。
(不這樣做可導致圖像受干擾或聲音失真)
- 改變風向時拿著機身下方。
(滾動機身可引致表面刮花或由架子脫落出來)
• 請用雙手拿著下方，然後托高少許改變方向。



- 此產品不適合身體、感官或精神功能遲緩，或缺乏經驗與知識的人（包括兒童）使用，除非他們在負責其安全的人的監督或指引下使用。
- 請看管好兒童，確保他們不會以本產品玩耍。
- 本電器只可使用隨附的電源裝置。
- 本電器必須使用對應本電器上的標記的安全特低電壓。

Safety precautions

Always follow these instructions

To avoid the possibility of causing injury to users or damage to property, please follow all the explanations written below.

- The following symbols differentiate the levels of danger and injury that may result if the product is improperly used.

 WARNING	This symbol indicates that improper handling may cause a risk of death or serious injury.
---	---

 CAUTION	This symbol indicates that improper handling may cause a risk of injury or damage to property.
---	--

- The following symbols indicate the type of instructions to be observed. (The symbols given below are examples.)

	This symbol denotes an action that is PROHIBITED .
--	---

	This symbol denotes a COMPULSORY action.
---	---

	This symbol denotes an action that should be performed carefully.
--	---

 WARNING

-  Do not damage the power cord or plug of the AC adaptor.

(Do not cut or modify. Do not forcefully bend, twist or pull. Do not put near heating appliances or put anything heavy on top. Do not bundle.)

If damaged power cord or plug is used, short circuit etc. may occur and cause electric shock or fire.

- Contact the dealer for repair of the power cord or plug.

If the supply cord is damaged, it must be replaced by the manufacturer, its service agent or similarly qualified persons in order to avoid a hazard.

-  Do not use more than the rating of the electrical outlet or wiring accessories.

Do not connect this product to a power supply except rated voltage and rated frequency.

If you exceed the rating by using a power strip etc., heat generation may occur and cause fire.

-  Do not connect or disconnect the AC adaptor with wet hands.

It may cause electric shock.

-  Do not stretch the power cord of AC adaptor during operation.

It may damage the power cord, resulting in short circuit that causes electric shock or fire.



-  Do not place the product on the power cord of its AC adaptor.

It may damage the power cord, resulting in short circuit that causes electric shock or fire.





-  Do not pull the power cord of the AC adaptor when carrying the product.

It may damage the power cord, resulting in short circuit that causes electric shock or fire.

-  Do not wind the power cord of AC adaptor around the main body and the stand.

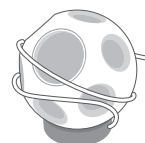
It may damage the power cord, resulting in short circuit that causes electric shock or fire.



-  When a failure or malfunction occurs, stop using the product immediately and disconnect the AC adaptor from the power supply.

Otherwise, heat generation may occur, causing electric shock or fire.

[Examples of failure/malfunction]

- The product does not operate, even though the power is turned on.
- Abnormal noise is observed during operation.
- Moving the power cord stops operation.
- Burning smell is found.
- The power cord or the AC adaptor becomes abnormally hot.
- Contact the dealer immediately for maintenance/repair.

-  Make sure the power plug of the AC adaptor is fully inserted into the socket.

Loose engagement of the plug and socket may cause electric shock or fire due to overheating.

- Do not use a damaged plug or loosen socket.

-  Always use with the supplied AC adaptor.

Failure to do so may cause electric shock or fire.

-  Wipe off dust on the power plug of AC adaptor periodically.

If the plug is used with dust accumulated on it, humid air etc. may cause poor insulation and fire.

- Disconnect the AC adaptor and wipe it with a dry cloth.
- Disconnect the AC adaptor when not using for a long period of time.

Safety precautions

Always follow these instructions



WARNING



Always use with the supplied stand.

If you use without the supplied stand or with a substitute, the product may fall down and cause injury.



Always place the product on the supplied stand, even when not in use.

The product may fall down and cause injury.



Do not put foreign objects such as metal into the gap of the air outlet or the air inlet of the product.

Touching the inside of the product may cause electric shock or fire due to short circuit.

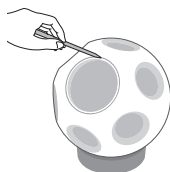

Never try to take apart, repair or modify this product.

Ignition or abnormal operation may occur, causing electric shock, fire or injury.

● Contact the dealer for repair of this product.



Do not immerse the product in water or splash water on it.

Short circuit may occur and cause electric shock or fire.



Do not put the product in places where pets or other animals may urinate on it.

Short circuit may occur, causing electric shock or fire.



Do not place the product near heating appliances.

Plastic parts may melt and catch fire.



Do not put the product in a high place.

The product may fall down, causing injury.



CAUTION



Do not use the product at the following locations:

■ Where it may be exposed to flammable gas or near sources of flame such as gas ranges.

■ Where it is exposed to rain or water.

■ High temperature, high humidity, or dusty places. (Greenhouse, plastic greenhouse, workshop, etc.)

Poisoning due to flame being extinguished, as well as ignition, explosion, short circuit, etc. may occur, causing electric shock or fire.



Do not use the product where insecticide spray, oil or chemicals are used.

■ Places where the chemicals are used, such as factories.

■ Places where fragrance or aroma oil are used for business.

• Deterioration of plastic parts may occur, resulting in breakage of the product that make the product fall down and cause injury.

• It may damage the power cord, resulting in short circuit that causes electric shock or fire.



Do not put the product in places where people may stumble.

People may fall down and become injured.



Put the product on flat and stable places.

Putting the product on unstable places may result in it falling down and causing injury.



Make sure to disconnect the AC adaptor when cleaning the product.

The product may start operating unexpectedly, causing injury or electric shock.



Do not swing around or carry the stand with the power cord of AC adaptor.

• It may damage the power cord, short circuit may occur and cause electric shock or ignition.

• The stand may come off and cause injury.



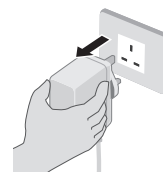

When disconnecting the AC adaptor, grasp and pull the AC adaptor, not the cord.

It may damage the power cord, resulting in short circuit that causes electric shock or fire.



 Do not ride or sit on the product.
It may cause injury.

 Do not play with the product by throwing, kicking, or rolling it.
It may cause the product to hit a person and cause injury. Special attention should be paid to children and pets.
• This product is not a toy.

 Do not use the product hanging on wall or ceiling.
The product may fall down and cause injury.

 Do not drag or carry the product while it is on the stand.
It may cause damage to the desk or floor, or may result in it falling down and causing injury.

 When moving the product, hold the lower portion to carry.

If you hold the induction air outlet or the induction air inlets of the product, it may fall down and cause injury.

- Before carrying, remove the AC adaptor from the main body.



 Do not put your hands, feet or head into the stand or the induction air outlet or induction air inlets of main body.
Your hands, feet or head may be injured or stuck.

 Do not expose yourself to wind generated by the product for a long time.
It may cause health related issues.

 Do not expose heating appliances to wind generated by the product.
Poisoning due to flame being extinguished, as well as ignition, explosion etc. may occur.

 Special attention should be paid when people such as the following use this product.

(Infants, children, elderly people, or people who cannot control their own body temperature)

If exposed directly to wind generated by the product for a long time, they may feel sick or become dehydrated.

Operating conditions

● Do not put the product where the air outlet, air inlet, induction air outlet or induction air inlet are blocked with curtain etc.

(It may degrade performance of the product.)

● Use the product away more than 1 m from TV, radio, or other AV appliances.

(Otherwise, distortion or noises may be caused.)

● When changing wind direction, hold the lower portion of the product.

(If you change direction while the product is on the stand, it may scratch the surface or cause it to fall down from the stand.)

- Hold the lower portion with both hands, lift it, and then change direction.



- This appliance is not intended for use by persons (including children) with reduced physical, sensory or mental capabilities, or lack of experiences and knowledge, unless they have been given supervision or instruction concerning use of the appliance by a person responsible for their safety.
- Children should be supervised to ensure that they do not play with the appliance.
- The appliance is only to be used with the power supply unit provided with the appliance.
- The appliance must only be supplied at safety extra low voltage corresponding to the marking on the appliance.

各部件名稱

Name of parts

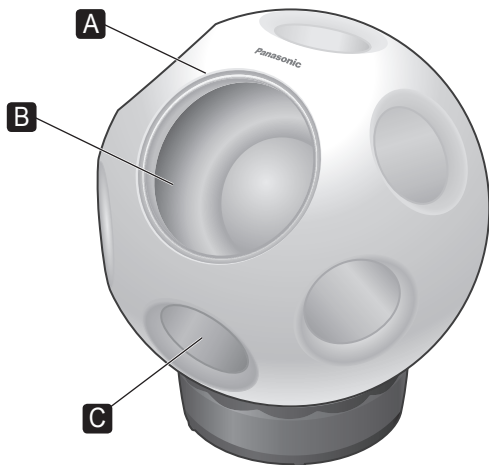

正面

- A** 出風口
- B** 導引出風口
- C** 導引進風口 (旁邊的 6 個風口)

Front

- A** Air outlet
- B** Induction air outlet
- C** Induction air inlet (There are six induction air inlets.)

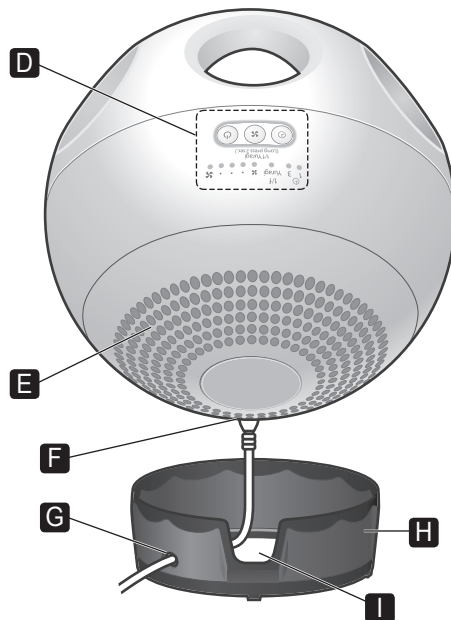

背面

- D** 操作面板
- E** 進風口 (內有過濾器)
- F** AC 配接器接口位
- G** 電源線開口
- H** 架子
- I** AC 配接器開口

Back

- D** Control panel
- E** Air inlet (Filter is installed inside.)
- F** Connection plug of the AC adaptor
- G** Power cord hole
- H** Stand
- I** AC adaptor opening

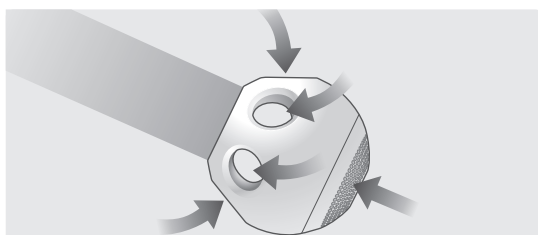

■ 風的流動

導引進風口會令由進風口吸入的空氣擴增，然後由導引出風口直接送風。

■ Flow of wind

The air taken from the air inlet is amplified by the induction air inlet, and then blown out straight from the induction air outlet.

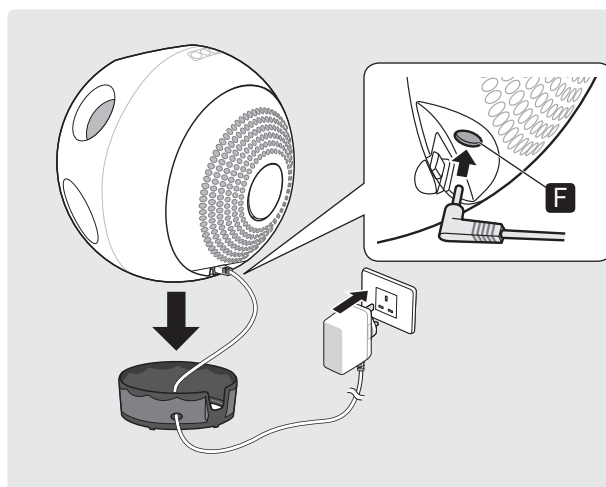

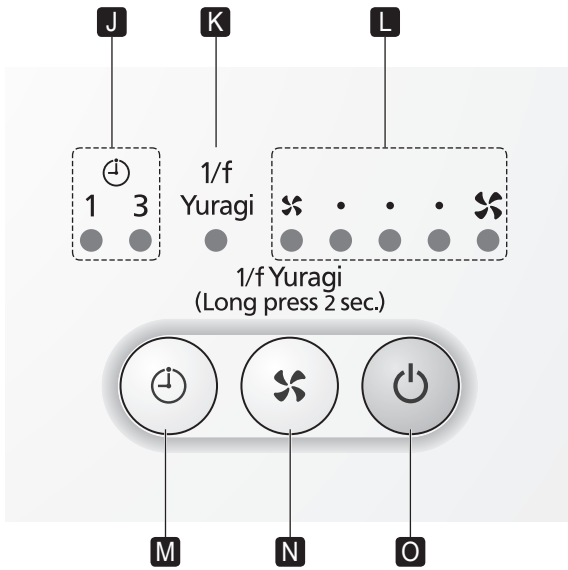

操作面板

- | | |
|--------------------------------|-----------------|
| J [關機定時器] 指示燈 (綠色) | M 關機定時器鈕 |
| K [1/f Yuragi] 指示燈 (橙色) | N 風速鈕 |
| L [風速] 指示燈 (綠色) | O 開/關鈕 |

Control panel

- | | |
|-------------------------------------|----------------------------|
| J [Off timer] lamp (green) | M Off timer button |
| K [1/f Yuragi] lamp (orange) | N Wind speed button |
| L [Wind speed] lamp (green) | O Off/On button |

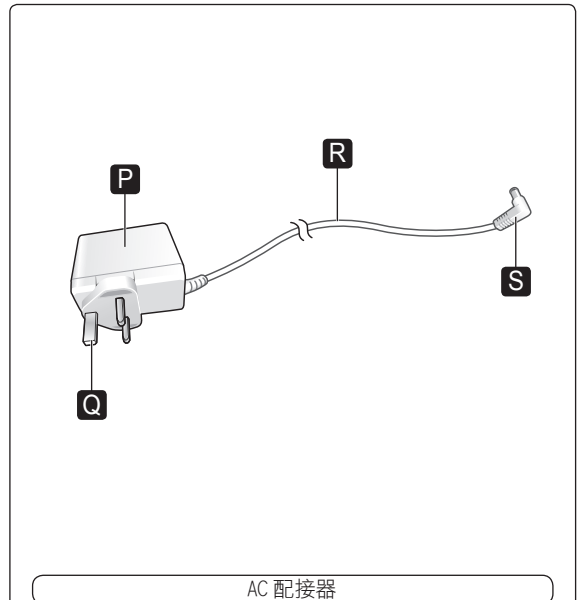

AC 配接器

- | |
|-------------------|
| P AC 配接器器身 |
| Q 電源插頭 |
| R 電源線 |
| S 機身連接插頭 |

只應使用隨附的 AC 配接器。隨附的 AC 配接器只供本產品使用，不要用在其他電器上。

AC adaptor

- | |
|------------------------------------|
| P AC adaptor body |
| Q Power plug |
| R Power cord |
| S Main body connection plug |

Always use with the supplied AC adaptor. The supplied AC adaptor is for this product only. Do not use with other appliances.

■ 使用前

- 1 確認 AC 配接器的電源線已穿過架子的電源線開口 **G**。(在購買時狀態)
- 2 將機身連接插頭 **S** 完全插入機身背面的 AC 配接器接口 **F**。
- 3 放置架子與所述 AC 配接器開口 **I** 朝上。
- 4 把機身放在架子上。
- 5 接駁 AC 配接器至電源。

■ Before use

- 1 Make sure that the power cord of the AC adaptor is inserted into the power cord hole **G** of the stand. (State at time of purchase)
- 2 Insert fully the main body connection plug **S** into the connection plug of the AC adaptor **F** at the back of the main body.
- 3 Place the stand with the AC adaptor opening **I** facing up.
- 4 Place the main body on the stand.
- 5 Connect the AC adaptor to the power supply.

■ 注意事項：

- 請勿由架子拆除 AC 配接器的電源線。
- 電源線若走了出來，必須將它穿過架子的孔才使用。

■ Attention:

- Do not remove the power cord of AC adaptor from the stand.
- Always use with the power cord inserted into the hole of stand.

使用方法

How to use

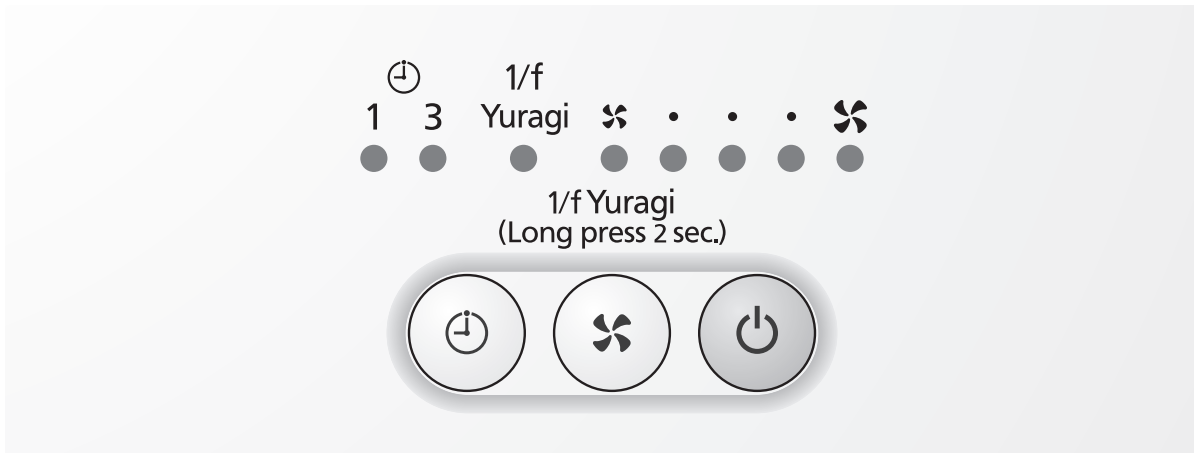

開／關

- 每次按下按鈕時，進行開關。
- 第一次使用時，電風扇的運作設定是風速「1」。
- 風速、關機定時器鈕只能夠在電風扇開啟時使用。

記憶功能

- 電源開啟時，電風扇會使用之前設定的風速、1/f Yuragi 開始操作。
(關機計時器的設定將不會被儲存。)
- 拔出插頭後，記憶將會消除。

Off/On

- Turn on or off with the button pressed.
- When using for the first time, the fan operates at the setting of wind speed "1".
- Wind speed and off timer buttons are enabled only when the fan is turned on.

Memory function

- When the product is turned on, the fan starts operation at the previously used wind speed setting and 1/f Yuragi.
(Off timer setting will not be retained in memory.)
- When unplugged, memory will be deleted.

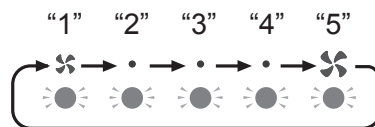

風速

- 風速有 5 個級別可供調校。
- 按掣可轉換至另一個風速設定。
(風速「5」時所有燈會亮起)

Wind speed

- Wind speed can be adjusted at 5 levels.
- Each press of the button will switch to the next wind speed setting.
(When wind speed "5" is set, all lamps are lit.)

■ 說明：

- 為免用家忘記關機，最後一次操作起 10 小時後會自動停止運行。
- 長時間不使用時，關閉電源，並拔除 AC 配接器以節省能源。(電風扇關閉時仍然會消耗大約 0.5 W 的電力。)
- 為了提高升降溫效果，建議使用電風扇時同時開冷氣或加熱器具。
- 使用計時器功能以節省能源或避免睡眠時過涼。

■ Note:

- To prevent the product from being left on when not in use, it turns off automatically when no operations are made for 10 hours.
- When not used for a long period of time, turn off the product and disconnect the AC adaptor from the power supply in order to save energy. (The fan consumes about 0.5 W even when turned off.)
- Use the fan with air conditioner or heating appliance is recommended in order to enhance heating and cooling effects.
- Use the timer function in order to save energy or avoid excess cooling while sleeping.



1/f Yuragi

- 長按風速鈕 2 秒，1/f Yuragi 指示燈會亮起，並開始運行 1/f Yuragi。
- 再按住風速鈕 2 秒以取消。

1/f Yuragi

- 1/f Yuragi 能夠精細地及自動控制風速，讓人享受自然及舒適的微風。

1/f Yuragi

- Press and hold wind speed button for 2 seconds. ([1/f Yuragi] lamp is lit and 1/f Yuragi operation starts.)
- Press and hold the button for 2 seconds again to cancel.

1/f Yuragi

- 1/f Yuragi enables you to enjoy a natural, comfortable breeze by automatically giving slight variations to the air speed.

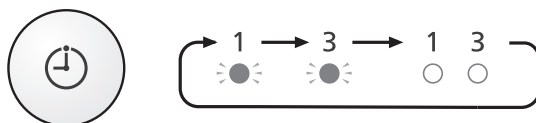

關機定時器

- 過了預設的時間後，電風扇會停止運作。
- 按掣可轉換至另一個定時設定。
- 取消時，所有燈會熄滅，但風扇會繼續運作。
- 隨著時間經過，指示燈會顯示大約的剩餘時間。
- 此按鈕只能在電風扇開啟時使用。(電風扇關閉時無法設定。)

Off timer

- The fan stops operation when the preset hours has passed.
- Each press of the button will switch to the next timer setting.
- When cancelled, all lamps turn off and the fan operates continuously.
- As time elapses, the lamps that are lit change to show the approximate remaining time.
- The button is enabled only when the fan is turned on. (You cannot set while the fan is turned off.)

Cleaning

■ 清洗前注意事項

請由電插座拔除 AC 配接器，並由機身脫掉連接機身用的插頭。

■ 注意事項：

- 除廚房使用的中性洗滌劑外，不得使用其他洗滌劑。（可能造成塑膠零件變質、變型或破損。）
- 請勿使用稀釋劑（天拿水）、揮發油、酒精、去污粉或鹼性洗滌劑等。
- 使用化學性抹布時，請按照其使用注意事項進行使用。

■ Before cleaning

Make sure to disconnect the AC adaptor from the power supply and remove the main body connection plug from the main body.

■ Attention:

- Do not use a detergent other than neutral detergent for kitchen purposes. (Deterioration, deformation or breakage of plastic parts may occur.)
- Do not use thinner, benzine, alcohol, cleaning powder, alkaline detergent, etc.
- When using chemically treated cloth, follow its instructions.

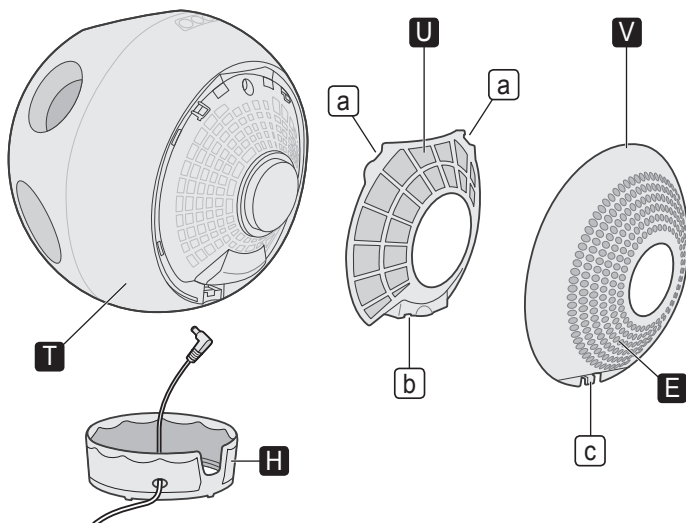

機身 **T**、過濾器蓋 **V** / 架子 **H**

使用擰乾的軟布擦拭。

- 使用質地較硬的布擦拭，可能會造成表面損害。

Main body **T** / Filter cover **V** / Stand **H**

Wipe with a soft cloth that has been wrung out well.

- Using a hard cloth may scratch the surface.

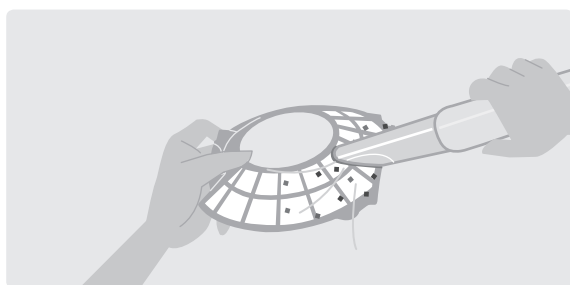

過濾器 **U** <約2星期1次>

用吸塵器等清除灰塵。

- 有頑固污漬時用水清洗。

■ 注意事項：

- 不要用力過猛或用吸塵器的管嘴刮，因為它很容易被損壞。（塵埃會從損壞部分進入機身並造成故障。）
- 未裝過濾器時請勿開機。（吸入的塵埃會進入機身內部，引致故障）
- 用水清洗過濾器後，請將它徹底弄乾。（機身內部會入水，引致故障）

Filter **U** <about once every 2 weeks>

Clean with vacuum cleaner etc.

- To remove stubborn stains, rinse the filter with water.

■ Attention:

- Do not apply excessive force or scratch with a nozzle of cleaner because it is easy to be damaged. (Dust may enter the main body from the damaged part and cause failure.)
- Do not turn on the fan unless the filter is installed properly. (Dust may be sucked inside the main body and cause failure.)
- After rinsing the filter, dry it completely. (Water may enter the main body and cause failure.)

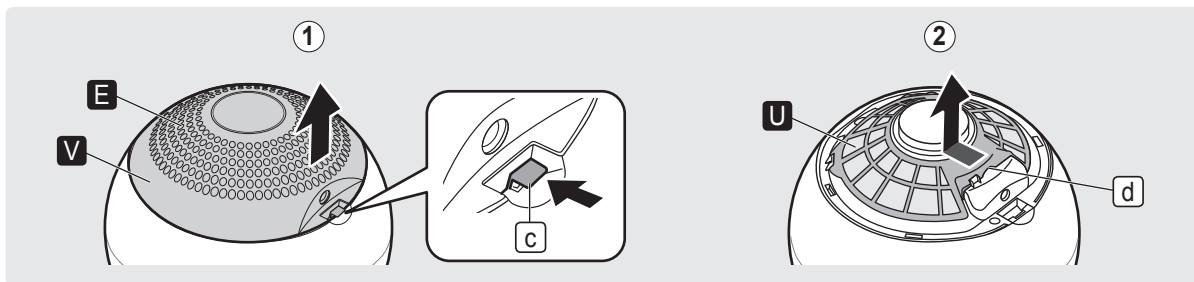

■ 拆卸過濾器蓋 V 及過濾器 U 的方法

① 拆除過濾器蓋 V。

- 向上擺放進風口 E，然後將過濾器蓋 V 的掛鉤部份 C 向內推，並將蓋拿起。

② 拆除過濾器 U。

- 將手指放入過濾器 U 與機身間的罅隙 d，然後向內推，並將過濾器 U 拿起。

■ How to remove the filter cover V and the filter U

① Remove the filter cover V.

- Place the main body with the air inlet E up. Pressing the lock portion C toward the inside, lift and remove the filter cover V.

② Remove the filter U.

- Put a finger in the gap d between main body and filter U. Pressing the filter U toward the inside, lift and remove it.

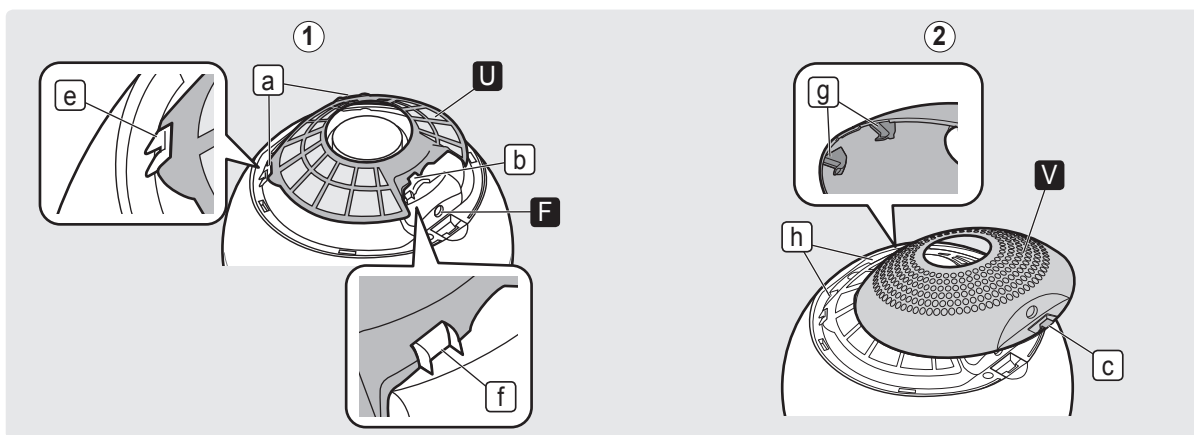

■ 安裝過濾器蓋 V 及過濾器 U 的方法

① 安裝過濾器 U。

- 將過濾器的切口部份 a (2 處) 勾在機身的爪 e，然後再將切口部份 b (1 處) 勾在機身的爪 f 以固定過濾器。該爪 f 靠近機身連接插頭用插座 F。

② 安裝過濾器蓋 V。

- 將過濾器蓋 V 的突起部份 g (2 處) 插入機身的鉤孔 h，然後將掛鉤 C 按入，直至聽到「啪」一聲。

■ 注意事項：

- 確保透過鉤入機身上的爪將過濾器安裝牢固。(否則，灰塵可能進入機身並造成故障。)

■ How to install the filter cover V and the filter U

① Install the filter U.

- Hook two notched parts a into tabs e on the main body, and then hook the other notched part b into a tab f on the main body to secure. The tab f is near the socket for main body connection plug F.

② Install the filter cover V.

- Insert the two projections g of the filter cover V into hook holes h on the main body, and then push the lock portion C until it clicks.

■ Attention:

- Make sure that the filter is installed securely by hooking into tabs on the main body. (Otherwise, dust may enter the main body and cause failure.)

要求維修服務前，請檢查以下項目。如果問題仍然存在，請拔除 AC 配接器的電源及機身上的機身連接插頭，然後聯絡零售商安排維修。

故障現象	檢查
按開／關鈕啟動時扇葉不轉動。	<ul style="list-style-type: none"> AC 配接器電源插頭是否已經完全及正確地連接？（第 9 頁）
風力很弱	<ul style="list-style-type: none"> 過濾器是否被塵埃阻塞？（第 12 頁）
電風扇停止運作。	<ul style="list-style-type: none"> 按住任何按鈕 8 秒，電風扇會基於安全理由而關閉。按一下開／關鈕，電風扇便會恢復運作。 自動停止功能使風扇由最後一次操作起約 10 小時後自動停止運行。再按一下開／關鈕，風扇將以停止時的風速再次啟動。

如果出現以下情況，請立刻聯絡零售商。

發出異常聲音。	<ul style="list-style-type: none"> 可能有異物進入了風扇，令內部受到破壞。 <ul style="list-style-type: none"> ▶ 聯絡零售商安排維修。
所有風速指示燈都閃爍。	<ul style="list-style-type: none"> 電風扇發生故障。 <ul style="list-style-type: none"> ▶ 聯絡零售商安排維修。

Before requesting service, please check the following. If the problem still persists, disconnect the AC adaptor from the power supply and the main body connection plug from the main body, and then contact a dealer for repair.

Symptom	Check
The fan does not operate when pressing the Off/On button to start.	<ul style="list-style-type: none"> Is the power plug of AC adaptor connected fully and correctly? (P.9)
The fan does not blow much air.	<ul style="list-style-type: none"> Is the filter clogged with dust? (P.12)
The fan stops operation.	<ul style="list-style-type: none"> When pressing and holding any button for 8 seconds, the fan turns off for safety reasons. The fan resumes operation when the Off/On button is pressed. When the automatic stop function activates after no operations are made for 10 hours, the product stops operation automatically. Press the Off/On button again to resume operation at the setting configured before stopping.

Please contact the dealer immediately in the cases shown below.

Abnormal sound is heard.	<ul style="list-style-type: none"> The fan may have foreign objects in it or there may be internal damage. <ul style="list-style-type: none"> ▶ Contact a dealer for repair.
All wind speed lamps blink.	<ul style="list-style-type: none"> The fan is malfunctioned. <ul style="list-style-type: none"> ▶ Contact a dealer for repair.

規格

Specifications

數值是當電風扇以風速「5」運作時。

型號	電壓 (V~)	頻率 (Hz)	耗電量 *1 (W)	風速 *2 (m/sec)	電線長度 (m)	重量 (kg)	尺寸 (mm)
F-25UGA	220 - 240	50	18	4.5	2.0	2.1	高 277 闊 250 深 250

*1 電風扇連接至電源且關機的情況下，耗電量大約是 0.5 W。

*2 最大風速數值由本公司的測量方法計算。(正面 75 cm)

The values shown are when the fan operates at wind speed "5".

Model No.	Voltage (V~)	Frequency (Hz)	Power *1 (W)	Air Velocity*2 (m/sec.)	Power cord length (m)	Weight (kg)	Dimensions (mm)
F-25UGA	220 - 240	50	18	4.5	2.0	2.1	H 277 W 250 D 250

*1 When the fan is connected to the power supply with the power turned off, power consumption is about 0.5 W.

*2 Air velocity is a value measured by a method specified by Panasonic. (at a distance 75 cm from the front of the product)

