

Panasonic®

電風扇
Electric Fan

30cm 起居室電風扇 說明書
30cm Living Fan Operating Instructions

型號
Model No. **F-30PLH**

This product is for indoor use only.

本產品只可在室內使用

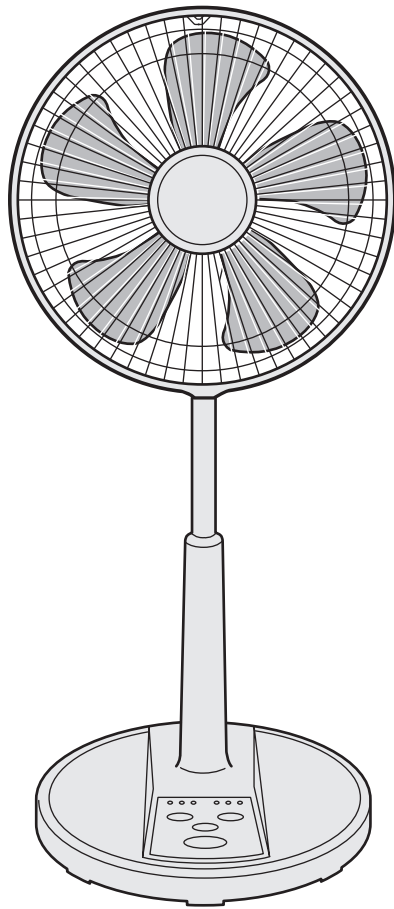

| 目錄 Contents | 頁數 Page |
|--------------------------------------|------------|
| 安全注意事項 Safety precautions | 2 |
| 如何裝配 How to assemble | 6 |
| 使用方法 How to operate | 8 |
| 清潔 / 規格 Cleaning / Specifications | 11 |

多謝閣下選購本 Panasonic 產品。

Thank you for purchasing this Panasonic product.

- 在使用本產品之前，請仔細閱讀使用說明書，並將使用說明書妥善保管，以備將來需要時之用。
- Before operating this product, please read the instructions carefully, and save this manual for future use.

安全注意事項 Safety precautions

請務必遵守
Always follow these precautions

為了避免對您自己或其他人造成可能的傷害或財物損害，請務必注意以下安全注意事項。

These safety precautions are provided for your protection. Please read and follow them carefully to avoid unnecessary injury and damage to the product itself or other properties.

■無視或錯誤理解這些標誌，會產生下列兩種情況。

■The following symbols differentiate the levels of danger and injury that may result if the product is not used specifically as instructed.



警告
WARNING

本標誌所表示的內容為“可能造成人員重傷或死亡”。

This symbol indicates that improper handling may cause a risk of death or serious injury.



注意
CAUTION

本標誌所表示的內容為“可能造成人身傷害或其他物品損害”。

This symbol indicates that improper handling may cause a risk of injury or damage to the product or to your properties.

■務必遵守的內容分類，用標誌區分說明如下：

■This manual uses a number of other symbols to indicate additional information for a particular item. (The symbols given below are examples.)



此標誌表示為禁止事項。

This symbol indicates an action that must not be performed.



此標誌表示為強制事項。

This symbol indicates an action that must be performed.



警告
WARNING

■切勿擅自拆散、修理或改造。

Never try to take apart, repair or modify this product.



會引致火災或觸電。
It may cause fire or electric shock.

禁止拆散
Do not take apart

- 若本品故障時請找經銷商修理。
Contact the dealer for repairing this product.

■裝配或拆除扇葉或保護網

時不可按高度調節按鈕。

Do not push the height adjustment button when assembling or removing blade and guards.



禁止
Prohibited

馬達及柱部可能會快速升高而擊傷使用者。
Motor and pole may rise rapidly and cause injury.

■不可接上220-230V~，50Hz以外的電源。

Do not connect this unit to power supply other than 220-230V~, 50Hz.



禁止
Prohibited

否則可能會引起火警。
Otherwise it may cause fire.

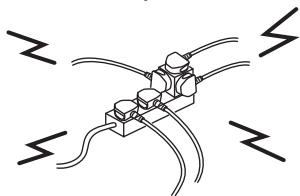

■確定電源插頭完全插入插座。

Make sure power plug is fully inserted into socket.



若插頭插得不好，可能會引致觸電或插頭過熱而造成火災。
Loose engagement of plug and socket may cause electric shock or fire due to overheat of plug.

- 不要使用已損壞的插頭或鬆脫的插頭。
Do not use damaged or loosen plug.



警告 WARNING

- 扇葉或保護網未裝好時切勿開機。
Do not turn on the unit if blade or guard is not installed properly.



禁止
Prohibited

引致受傷
Causing injury

- 不可讓風扇沾水。
Do not contact with water.



禁止沾水
Avoid water

引起火災或觸電。
Causing fire or electric shock.

- 勿令電線或插頭損壞。
Do not damage power cord or power plug.

（例如對其加工、放在發熱器具附近，不正常地折曲或扭曲、強行拉長、負重、把電線捆成一扎。
e.g. modify, put near heat generating appliance, abnormally twist or bend, forcefully elongate, pull heavy weight, bundle up power cord.



禁止
Prohibited

引致受傷、觸電、甚至因短路引起火災。
Causing injury, electric shock or even fire due to short circuit.

為免造成傷亡，如電源線損壞必須送交其製造商或製造商指定的維修代理或類似的合資格人士作更換。
If the supply cord is damaged, it must be replaced by the manufacturer or its service agent or a similarly qualified person in order to avoid a hazard.

- 手濕時切勿接觸電源插頭。
Never touch the plug if your hands are wet.



手濕不可觸碰
No wet hand

可能會引致觸電。
May cause electric shock.

- 清潔本機前，請拔出電源插座。
Be sure to disconnect the power plug before cleaning the unit



拔掉插頭
Unplug

本機可能會無預期地開始運作，且可能引致觸電。
The unit may start operating unexpectedly and electric shock may occur.

- 要定期清除電源插頭及插座上之灰塵。
Wipe off dust on the plug and socket periodically.



如果電源插頭上積聚了灰塵，天氣潮濕時會容易引致絕緣不良而導致火災。
Accumulation of dust on plug in humid season may cause poor insulation and may result in fire.

- 請將電源插頭拔出，用乾布抹淨。
Disconnect from power supply and use a piece of dry cloth to clean the plug.
- 若長時期不使用風扇，請將電源插頭拔出。
Unplug the fan if it will not be used for a period.

安全注意事項 Safety precautions

請務必遵守
Always follow these precautions



警告 WARNING

■ 移動時切勿拉扯電源線。

Do not pull on the power cord when carrying the unit.



禁止
Prohibited

可能損壞電線內部，
導致火災或觸電事故。

It may damage the wires
inside the cord, and fire or
electric shocks may occur.

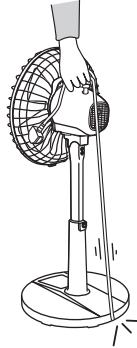

■ 切勿在電風扇運作時拉緊電線。

Do not stretch the power cord while
the unit is in use.



禁止
Prohibited

可能導致短路或折斷電線內的
金屬線，這樣可能會發生火災
或觸電。

It may cause shortcircuits or
broken wires which may cause
fire or electric shocks.

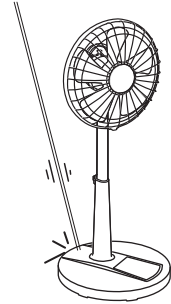

■ 切勿將電風扇放近熱源。

Do not place the unit near a heat source.



禁止
Prohibited

塑膠零件可能會
熔化並導致火災。

Plastic parts may melt
and cause fire.

■ 切勿損壞電源線或插座。

Do not do anything that may damage
the power cord or power plug.



禁止
Prohibited

■ 請勿擠壓電源線。

Do not clamp the power cord.



禁止
Prohibited

若未能注意這種情況，
電源線可能發生短路或破損，
並可能導致火災或電擊。

If this is not observed, short-circuits
or breakages may occur in the cord,
and fire or electric shocks may result.



- 切勿割割、改裝、過度扭曲、拉扯、扭轉和擰絞電源線。
切勿在電源線上放置重物或擠壓。
(使用已破損的電源線可能會導致觸電或火災事故。)
- 要修理時，請與商戶聯繫。
- 如果機器的電源線損壞了，必須找該機器的廠商，
維修服務中心或合資格技術人員替您更換以防危險發生。
- Power cord must not be damaged, modified, bent,
pulled, twisted or wrapped into a bundle.
Also, do not place heavy objects on top of it or clamp in.
(If damaged power cord is being used, electric shock or
fire may occur.)
- Consult distributors to carry out any repairs.
- If the supply cord is damaged, it must be replaced by
the manufacturer, its service agent or similarly qualified
persons in order to avoid a hazard.



注意 CAUTION

- 不要在以下場所使用風扇：接近氣體爐具；有易燃氣體的地方；有雨淋或容易被滴水的地方。
Do not use under the following situations:
Near gaseous fuel cooker and inflammable gas; place which is exposed to rain fall or water pour.



禁止
Prohibited

可能會吹熄爐火，引致漏氣及爆炸；引致觸電、短路、火災。
May cause gaseous fuel leakage and explosion; Leading to electric shock, over heat, fire and explosion.

- 不要長時間把風扇吹著身體。
Avoid continuous exposure to direct wind from the fan.



禁止
Prohibited

導致身體不適。
It may cause discomfort.

- 要拔出電源插頭時，必須抓住電源插頭來拔，不能拉電源線。
Hold the plug when disconnect from main supply, never pull the cord.



可能會造成電線短路或斷線而引致火災或觸電。
May cause short circuit or damage of power supply cord and lead to fire or electric shock.

- 將機桿牢固地插入底座之前，切勿操作機組。
Do not operate the set before the pole is firmly inserted onto the base.



禁止
Prohibited



如果風扇狀態不穩定，則可能會倒下。
Being unstable, may cause the fan to fall.

- 不要把風扇放置在不平坦的地方或障礙物周圍。
Don't place the fan on unstable surface or near obstacles.



禁止
Prohibited

容易引致風扇倒下而導致受傷。
Risk on injury by falling fan.

- 切勿用手指插入網罩中或各可動部分。
Do not put your fingers into the guard or any moving part of the fan.



禁止接觸
Don't touch

引致受傷。
Causing injury.

- 請勿在直接日照、雨淋風吹的位置使用。
Do not use in places which are exposed to direct sunlight, rain or wind.



禁止
Prohibited

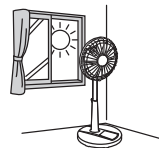

本機可能會過熱、著火或引致觸電。
The unit may overheat, and fire or electric shocks may occur.

注意 Notice

- 不要把風扇放在接近殺蟲劑、油或腐蝕性物品的地方使用（引致風扇變質或損壞）。
Do not put the fan near insecticide, oil corrosive solvent (may cause bad effects on quality or damages).
- 不要把風扇放在高溫、濕度高或塵埃多的地方使用（引致風扇變質或損壞）。
Do not put the fan in high temperature, high humidity or dusty place (may cause bad effects on quality or damages).
- 本產品不適合有殘障、智障或精神障礙的人士、缺乏經驗及常識者（包括兒童）使用，除非負責他們安全的人士在場看護或指導。
兒童在使用本產品期間，需要有人在場看護，以防將產品當作玩具。
This appliance is not intended for use by persons (including children) with reduced physical, sensory or mental capabilities, or lack of experience and knowledge, unless they have been given supervision or instruction concerning use of the appliance by a person responsible for their safety.
Children should be supervised to ensure that they do not play with the appliance.

如何裝配 How to assemble

安裝底座 Installing the base

- 將架子的凸桿插入底座的孔洞中，然後將架子推入底座中，直到卡入定位為止。
Insert the projection on the stand into the hole in the base, and then push the stand into the base until it clicks into place.

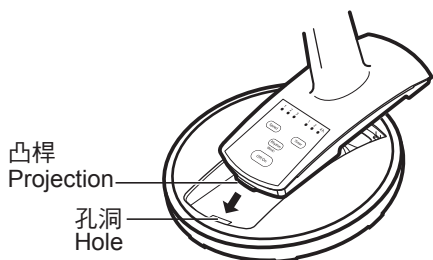

- 握住主機體，讓它面朝下（如圖例所示），然後以順時針方向旋轉螺帽，將架子固定到底座。
Hold the main unit so that it is facing downward as shown in the illustration, and then turn the nut clockwise to secure the stand to the base.

- 牢牢地鎖緊螺帽，讓螺帽不致鬆脫。
Tighten the nut securely so that it will not loosen.

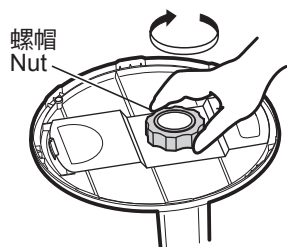

從底座移除架子時 When removing the stand from the base

移除螺帽，然後將底座的兩個調整片朝箭頭的方式移動來移除底座。
Remove the nut, and then slide the two tabs of the base in the directions of the arrows to remove the base.

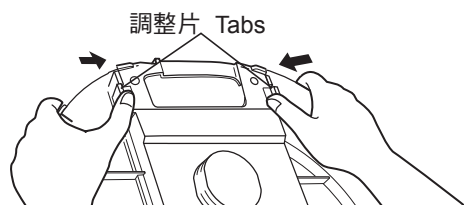

裝上後保護網 Assemble Rear Guard

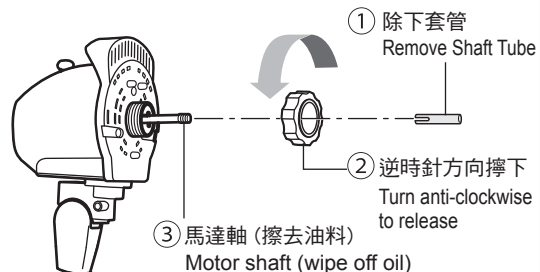

- 請不要扔掉套管，以便收藏風扇時套回（有助防止馬達軸氧化）。
Please keep the plastic tube for future storing (Prevent motor shaft from rusting).

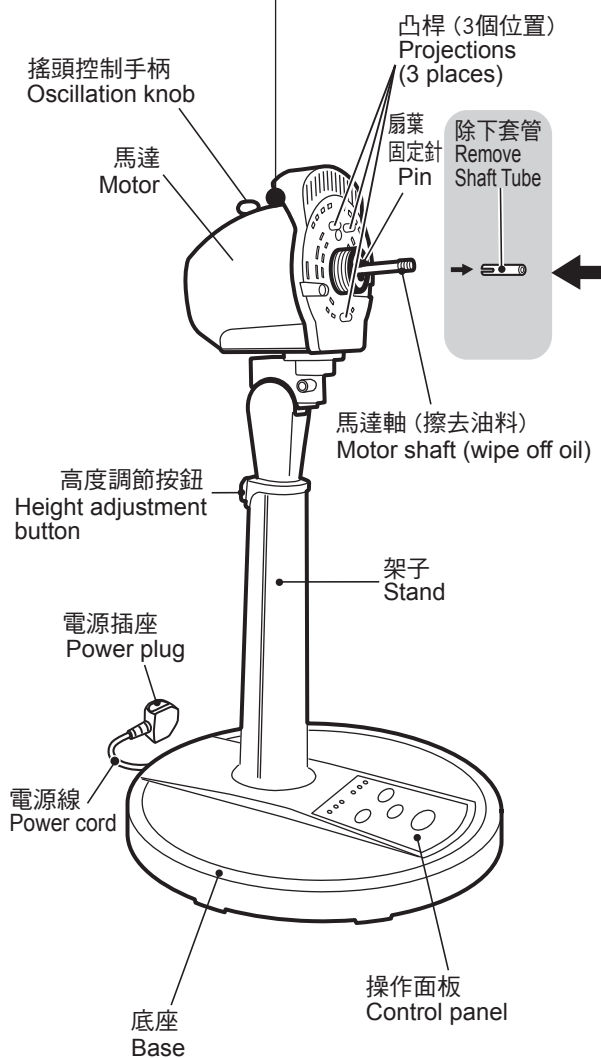

扇葉的安裝 Assemble Blade

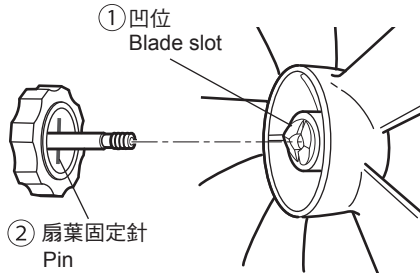

將馬達軸上的固定針對齊風扇中的凹槽。
Align the pin on the motor shaft with the groove in the fan.

注意 Notice

- 請確保擰緊保護網固定螺母和旋蓋以防在使用中鬆脫。
Please tighten the guard set nut and spinner firmly to prevent them from loosening.

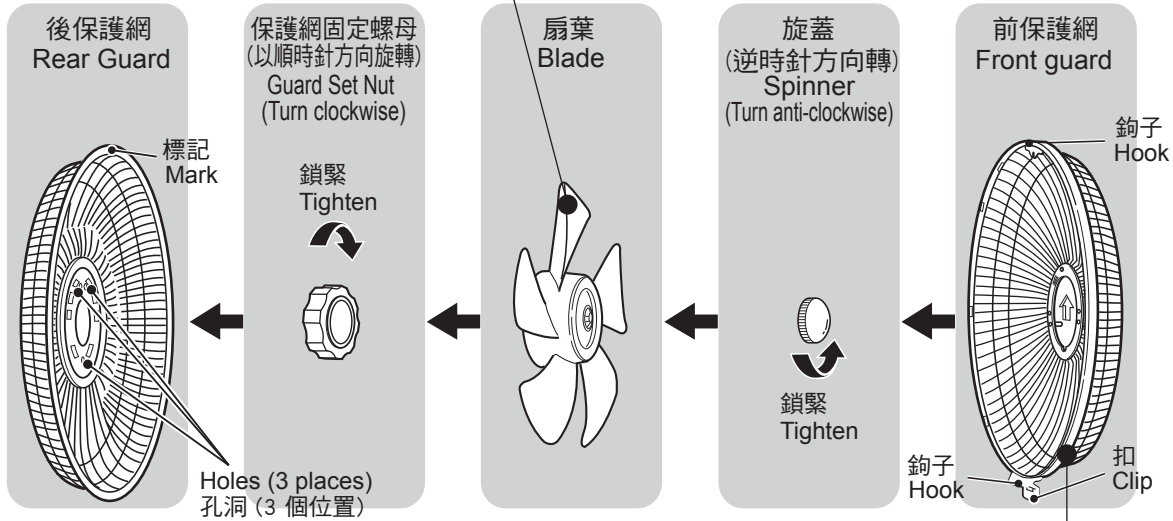

安裝前保護網 Assemble Front Guard

- 前保護網安裝方法之注意事項
Note on installation method for front guard

前後保護網對位
Match front and rear guards

以由上到下的順序插入
(一路到底)
Insert in order from top
to bottom
(all the way around)

將扣固定在右圖所示的位置。
推入扣，直到卡入定位為止。
Securely engage the clip in the
position shown in the illustration
at right.
Push in until it clicks into place.

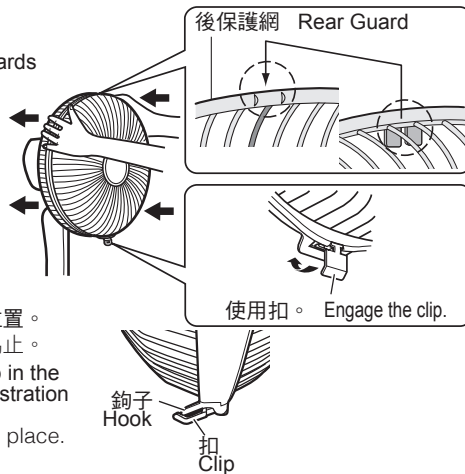

- 如果保護網套環由前保護網脫落
If guard ring falls out from front guard

- ① 將「配合標記」扣入爪部
Place the "Marked spot" directly
under the notch
- ② 將餘下的爪全部扣上
Clip on all remaining notches

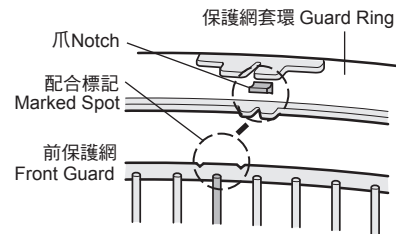

使用方法 How to operate

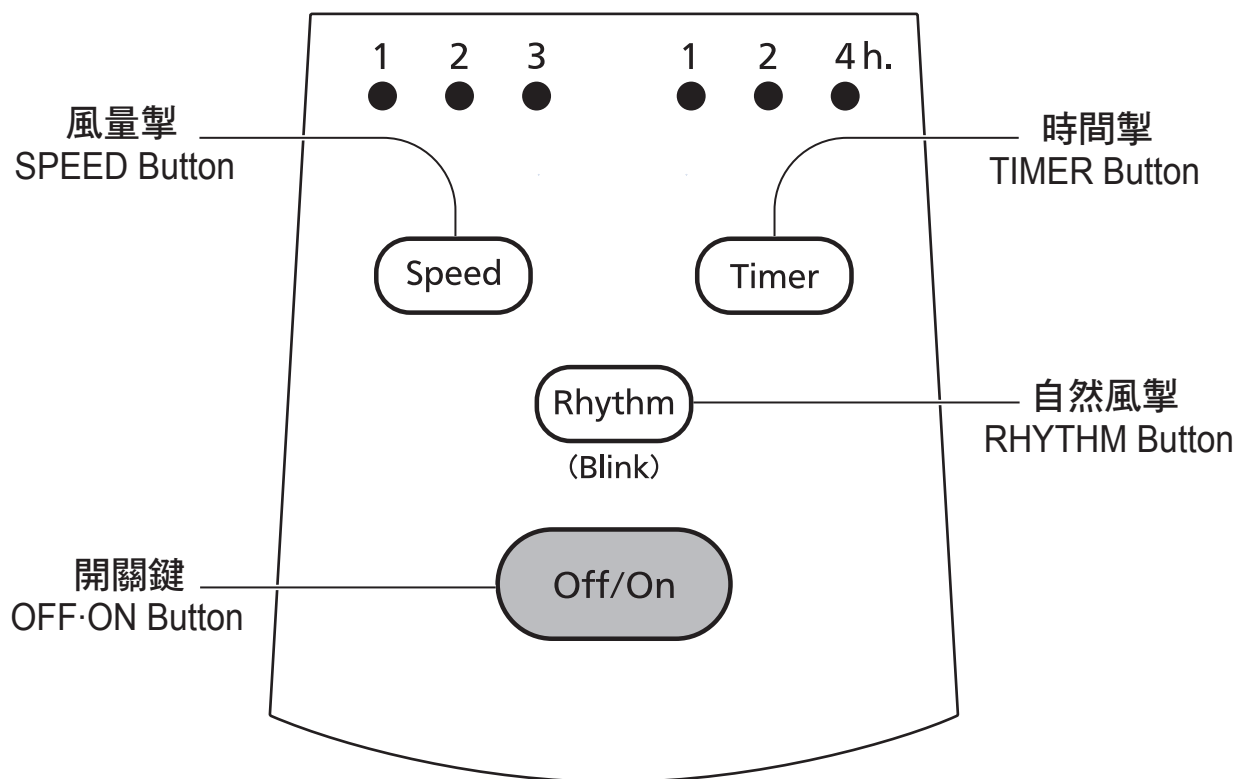

開關鍵 OFF·ON Button

每按鍵一次切換開關狀態

Press to toggle OFF·ON

- 第一次接通電源後，開始是慢檔
The speed is "1" at the first time after connecting to power supply.
- 風扇未開時其他按掣沒有作用
Other buttons will not function when the fan is turned off.

記憶功能 Memory function

- 關機後再次開機，運轉狀態和關機前相同
- 時間掣並無記憶功能
- 切斷電源後記憶會消失
- When turn on the fan, it operates at previously set mode.
- No memory function for "Timer"
- Memory will be cleared when cut off power

與空調配合使用能有效節能

Using with air-conditioner can save energy

風量掣 SPEED Button

按此鍵切換風量

Press this button to change wind speed.

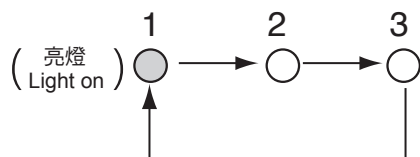

適當地調節風力及啟動風扇搖頭能增強涼快感覺
Properly adjust wind speed and activate oscillation can enhance the cooling effect.

時間掣 TIMER Button

每按一次時間掣如下圖所示變換時間掣的設定

Press this button to set the timer as shown below.

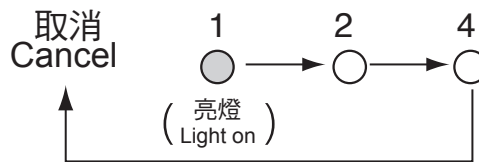

- 指示燈會隨剩餘時間減少而改變
Indicating lamp will change accordingly as remaining time reduces.

適當地使用時間掣既可省電又可避免
睡著時著涼
Proper use of Timer can save energy
and prevent user from discomfort.

自然風掣 RHYTHM Button

按此鍵以切換自然風或連續運轉模式

Press to toggle "Rhythm" or "Continuous" operation

注意 Notice

自然風就是每隔4秒自動改變風速（自然風模式啟動時風速指示燈會閃爍）

The wind strength is automatically changed at about 4 sec. intervals. (Speed indicating light will blink when rhythm mode is activated)

善用不同的風量、時間掣和自然
風的組合能令使用者倍感舒適。
Use different combinations of speed,
timer setting and rhythm function to
achieve most comfortable feeling.

注意 Notice

- 按下按鈕時，會響起操作指示聲。
When the button is pressed there will be a sound that indicates the operation.
- 若長時間不使用風扇時，請拔電源插頭以節省能源（即使在關機狀態風扇仍會消耗若1W的電能）
In order to save energy, disconnect unit from power source if it will not be used for a period.
(The fan consumes about 1W power even at "OFF" mode)
- 有時風扇會因承托面凹凸不平而震動並發出雜聲，這時請略為移動風扇的位置或調較風扇的高度直到風扇不再震動及發出雜聲。
The fan may vibrate and make a loud noise if the supporting surface is not flat or level. If this happens, please move the fan a little bit or adjust its height until the vibration and noise stop.
- 請根據以下書面說明操作，以避免使用者受傷或損害財物。
製造商無須對因安裝瑕疵或安裝不完全所造成的事故或傷害負責。
To avoid the possibility of causing injury to users or damaging properties, please follow all the explanation written below.
The manufacturer is not responsible for accidents and injuries caused by defective or deficient installation.

使用方法 How to operate

搖頭 Oscillation

搖頭角度80° Oscillation angle 80°

按下搖頭
Push down to
oscillate



拉上停止
Pull up to stop

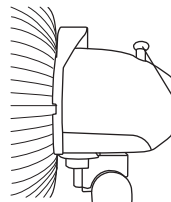

搖頭控制手柄
Oscillation knob

風向調節 Adjustment of Wind Direction

可左右自由調節
Adjust
horizontally

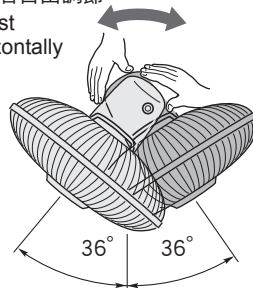

可上下調節
Adjust vertically

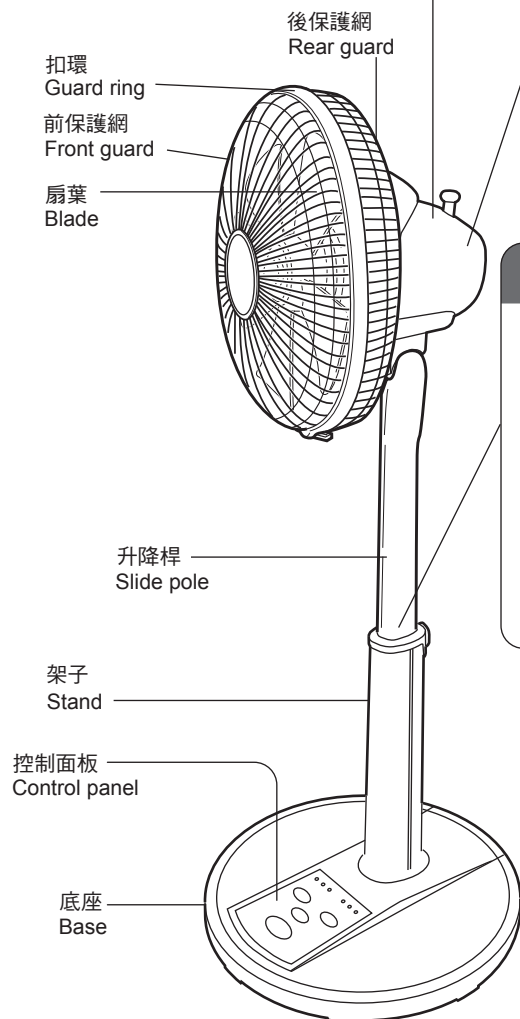
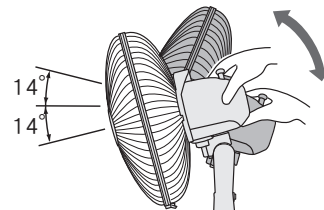

高度調節 Height Adjustment

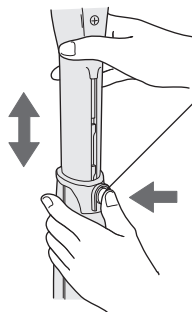

高度調節按鈕
Height adjustment button

升高：按下調節鈕，將升降桿提高至所需位置後放開按鈕。
下降：將升降桿按下至所需位置。

Elevating: Push and hold the adjustment button, pull up the slide pole to desired position, then release the button.

Lowering: Push down the slide pole to desired position.

清潔 / 規格 Cleaning / Specifications

清潔本機前，請拔出電源插座。
Be sure to disconnect the power plug before cleaning the unit.

清潔 Cleaning

- 弄濕抹布，用力扭乾，然後用來抹拭主機外圍。
 - 要清除頑固污漬，可用水混合少量稀釋的廚房清潔劑一起清洗。
- Dampen a cloth, wring it out firmly, and then use it to wipe the outer part of the main unit.
 - For stubborn stains, use water mixed with a small amount of diluted kitchen detergent.

須知 Notice

- 防止刮花塑膠部份，請不要用乾布大力擦拭。
- 防止機身變質、變色，請不要用稀釋劑、石油精、酒精、去污粉、鹼性清潔劑等清洗。
- 使用化學抹布時，請先詳閱其使用說明。
- Rubbing too heavily with dry cloth may scratch the surface of plastic parts.
- Do not use thinner, benzene, alcohol, cleaning powder, alkaline detergent, etc.
- When using chemically treated cloth, please follow its instructions.



規格 Specifications

| 電壓 Voltage (V~) | 頻率 Frequency (Hz) | 耗電量 Power (W) | 轉速 r.p.m. (r/min.) | 風速 Air Velocity (m/min.) | 風量 Air Volume (m ³ /min.) | 搖頭角度 Oscillation | 電線長度 Cord Length (m) | 重量 Weight (kg) | 尺寸 Dimension (mm) |
|-----------------------|-------------------------|---------------------|--------------------------|--------------------------------|--|---------------------|----------------------------|----------------------|-------------------------|
| 220 | 50 | 36 | 1040 | 200 | 43 | 0° , 80° | 2 | 3.6 | 高H690~875 |
| 230 | 50 | 38 | 1050 | 202 | 44 | | | | 闊W 367 |
| | | | | | | | | | 深D 350 |

Panasonic Corporation

Web Site : <http://panasonic.net/>

© Panasonic Ecology Systems Co., Ltd. 2012

B000760880
K1111Y0