

Panasonic®

EX750H series

English

Operating Instructions LED TV

50-inch model

58-inch model

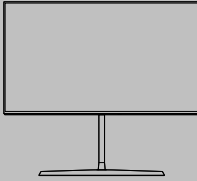

65-inch model

75-inch model



VIERA

For more detailed instructions, please refer to
[eHELP] (Built-in Operating Instructions).

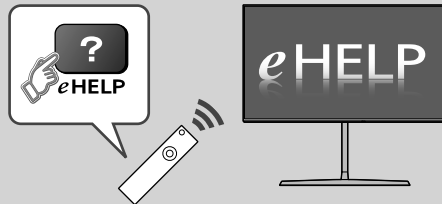

- How to use [eHELP] → (p. 25)

Thank you for purchasing this Panasonic product.

Please read these instructions carefully before operating this product and retain them for future reference.

Please carefully read the "Safety Precautions" of this manual before use.

The images shown in this manual are for illustrative purposes only.

M0417-1057



TQB4GC1667-1

English

 **DOLBY AUDIO™**



- For information about the trademarks, refer to [eHELP] (Search by Purpose > Read first > Before use > Licence).

Contents

Be Sure to Read

Important Notice	3
Safety Precautions	4

Quick Start Guide

Accessories	7
Connections	16
Identifying Controls	22
First time Auto Tuning	24

Using your VIERA

Watching TV	25
How to Use eHELP	25
Viewing 3D images	26

Others

FAQs	28
Maintenance	29
Specifications	29

The illustration for TH-58EX750H is used in this manual unless otherwise mentioned.
Illustrations shown may be different between models and countries.

Important Notice

Notice for Digital terrestrial broadcasting functions

- Function related to Digital broadcasting will work in the areas where the digital terrestrial broadcasting services are received. Consult your local Panasonic Dealer with coverage areas.
- Not all the features are available depending on the country, area, broadcaster and service provider.
- This TV has the capability for Digital broadcasting specifications. But future Digital broadcasting services cannot be guaranteed.

Panasonic does not guarantee operation and performance of peripheral devices made by other manufacturers; and we disclaim any liability or damage arising from operation and/or performance from usage of such other maker's peripheral devices.

The recording and playback of content on this or any other device may require permission from the owner of the copyright or other such rights in that content. Panasonic has no authority to and does not grant you that permission and explicitly disclaims any right, ability or intention to obtain such permission on your behalf. It is your responsibility to ensure that your use of this or any other device complies with applicable copyright legislation in your country. Please refer to that legislation for more information on the relevant laws and regulations involved or contact the owner of the rights in the content you wish to record or playback.

This product is licensed under the AVC patent portfolio license for the personal and non-commercial use of a consumer to (i) encode video in compliance with the AVC Standard ("AVC Video") and/or (ii) decode AVC Video that was encoded by a consumer engaged in a personal and non-commercial activity and/or was obtained from a video provider licensed to provide AVC Video. No license is granted or shall be implied for any other use.

Additional information may be obtained from MPEG LA, LLC.

See <http://www.mpegla.com>.

Panasonic and its affiliates make no representations or warranties of any kind with respect to the USB devices and the performance of communication between the USB devices and the USB port of Panasonic products, and expressly disclaims any and all warranties, whether express or implied or otherwise, including without limitation any implied warranty of fitness for a particular purpose, any loss of data, and any implied warranties arising from course of dealing or course of performance of data communication between the USB devices and the USB port of Panasonic products.

Transport only in upright position.



This mark shows that the construction of the product is double-insulated.



This mark indicates the product operates under AC voltage.

Safety Precautions

To help avoid risk of electrical shock, fire, damage or injury, please follow the warnings and cautions below:

■ Mains plug and lead

Warning

If you detect anything unusual, immediately remove the mains plug.

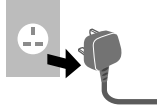

- This TV is designed to operate on AC ~ 220-240 V, 50 / 60 Hz.
- Insert the mains plug fully into the mains socket.
- To turn Off the apparatus completely, you must pull the mains plug out of the mains socket. Consequently, the mains plug should be easily accessible at all times.
- Disconnect the mains plug when cleaning the TV.
- Do not touch the mains plug with wet hands.



- Do not damage the mains lead.

- Do not place a heavy object on the lead.



- Do not place the lead near a high temperature object.



- Do not pull on the lead. Hold onto the mains plug body when disconnecting the plug.



- Do not move the TV with the lead plugged into a mains socket.
- Do not twist the lead, bend it excessively or stretch it.
- Do not use a damaged mains plug or mains socket.
- Ensure the TV does not crush the mains lead.

■ Take care

Warning

- Do not remove covers and never modify the TV yourself as live parts are accessible and risk of electric shock when they are removed. There are no user serviceable parts inside.



- Do not expose the TV to rain or excessive moisture. This TV must not be exposed to dripping or splashing water and objects filled with liquid, such as vases, must not be placed on top of or above the TV.



- Do not insert foreign objects into the TV through the air vents.
- If the TV is used in an area where insects may easily enter the TV.

It is possible for insects to enter the TV, such as small flies, spiders, ants, etc. which may cause damage to the TV or become trapped in an area visible on the TV, e.g. within the screen.

- Do not use an unapproved pedestal / mounting equipment. Be sure to ask your local Panasonic dealer to perform the setup or installation of approved wall-hanging brackets.

- Do not apply any strong force or impact to the display panel.

- Ensure that children do not climb on the TV.

- Do not place the TV on sloping or unstable surfaces, and ensure that the TV does not hang over the edge of the base.



Warning

Never place a TV in an unstable location. A TV may fall, causing serious personal injury or death. Many injuries, particularly to children, can be avoided by taking simple precautions such as:

- Using cabinets or stands recommended by the manufacturer of the TV.
- Only using furniture that can safely support the TV.
- Ensuring the TV is not overhanging the edge of the supporting furniture.
- Not placing the TV on tall furniture (for example, cupboards or bookcases) without anchoring both the furniture and the TV to a suitable support.
- Not placing the TV on cloth or other materials that may be located between the TV and supporting furniture.
- Educating children about the dangers of climbing on furniture to reach the TV or its controls.

If your existing TV is being retained and relocated, the same considerations as above should be applied.

- Do not expose the TV to direct sunlight and other sources of heat.



To prevent the spread of fire, keep candles or other open flames away from this product at all times



■ Suffocation / Choking Hazard

Warning

- The packaging of this product may cause suffocation, and some of the parts are small and may present a choking hazard to young children. Keep these parts out of reach of young children.

■ Pedestal

Warning

- Do not disassemble or modify the pedestal.

Caution

- Do not use any pedestal other than the one provided with this TV.
- Do not use the pedestal if it becomes warped or physically damaged. If this occurs, contact your nearest Panasonic dealer immediately.
- During setup, make sure that all screws are securely tightened.
- Ensure that the TV does not suffer any impact during installation of the pedestal.
- Ensure that children do not climb onto the pedestal.
- Install or remove the TV from the pedestal with at least two people.
- Install or remove the TV according to the specified procedure.

■ Radio waves

Warning

- Do not use the TV in any medical institutions or locations with medical equipment. Radio waves may interfere with the medical equipment and may cause accidents due to malfunction.
- Do not use the TV near any automatic control equipment such as automatic doors or fire alarms. Radio waves may interfere with the automatic control equipment and may cause accidents due to malfunction.
- Keep at least 15 cm away from the TV if you have a cardiac pacemaker. Radio waves may interfere with the operation of the pacemaker.
- Do not disassemble or alter the TV in any way.

■ Built-in wireless LAN

Caution

- Do not use the built-in wireless LAN to connect to any wireless network (SSID*) for which you do not have usage rights. Such networks may be listed as a result of searches. However, using them may be regarded as illegal access.

*SSID is a name for identifying a particular wireless network for transmission.

- Do not subject the built-in wireless LAN to high temperatures, direct sunlight or moisture.
- Data transmitted and received over radio waves may be intercepted and monitored.
- The built-in wireless LAN uses 2.4 GHz and 5 GHz frequency bands. To avoid malfunctions or slow response caused by radio wave interference when using the built-in wireless LAN, keep the TV away from other devices that use 2.4 GHz and 5 GHz signals such as other wireless LAN devices, microwave ovens, and mobile phones.
- When problems occur due to static electricity, etc., the TV might stop operating to protect itself. In this case, turn the TV off at the Mains power On / Off switch, then turn it back on.

■ Bluetooth® wireless technology

Caution



- The TV uses the 2.4 GHz radio frequency ISM band (Bluetooth®). To avoid malfunctions or slow response caused by radio wave interference, keep the TV away from the devices such as other wireless LAN devices, other Bluetooth devices, microwaves, mobile phones and the devices that use 2.4 GHz signal.

■ Ventilation

Caution

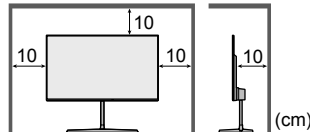
Allow sufficient space (at least 10 cm) around the TV in order to help prevent excessive heat, which could lead to early failure of some electronic components.



- Ventilation should not be impeded by covering the ventilation openings with items such as newspapers, tablecloths and curtains.  
- Whether you are using a pedestal or not, always ensure the vents at the bottom of the TV are not blocked and there is sufficient space to enable adequate ventilation.

■ Moving the TV

Caution

Before moving the TV, disconnect all cables.

- At least two people are required to move the TV.

Support the TV as shown below to prevent injury that may be caused by the tipping or falling of TV.

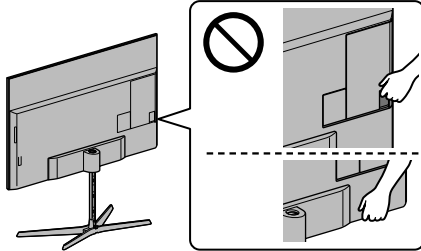

■ When not in use for a long time

Caution

This TV will still consume some power even in the Off mode, as long as the mains plug is still connected to a live mains socket.

- Remove the mains plug from the wall socket when the TV is not in use for a prolonged period of time.

■ Use conditions

Caution

- This appliance is intended for use in tropical climates.

■ Excessive volume

Caution

- Do not expose your ears to excessive volume from the headphones. Irreversible damage can be caused.
- If you hear a drumming noise in your ears, turn down the volume or temporarily stop using the headphones.



■ Battery for the Remote Control

Caution

- Incorrect installation may cause battery leakage, corrosion and explosion.
- Replace only with the same or equivalent type.
- Do not mix old and new batteries.
- Do not mix different battery types (such as alkaline and manganese batteries).
- Do not use rechargeable batteries (Ni-Cd, etc.).
- Do not burn or break up batteries.
- Do not expose batteries to excessive heat such as sunshine, fire or the like.
- Make sure you dispose of batteries correctly.
- Remove the battery from the unit when not using for a prolonged period of time to prevent battery leakage, corrosion and explosion.

■ Viewing 3D Images

Caution

- Pay special attention when children are viewing 3D images. 3D images should not be viewed by children younger than about 6 years old, as a guideline. All children must be fully supervised by parents or guardians who must ensure their safety and health while they are viewing 3D images.
- Stop viewing 3D images immediately if you feel tired, feel unwell, experience any other uncomfortable sensation or clearly see double images. Take an appropriate break before continuing to view. When you set the 3D effect by using [3D Adjustment], take into account that the vision of 3D images varies among different individuals.
- Do not view 3D images if you have a history of oversensitivity to light, heart problems or any other medical conditions.
- When viewing 3D images, your sense of distance may be tricked or go wrong. Be careful not to hit the TV screen or other people unintentionally. Ensure there are no breakable objects around you to avoid any accidental damage or injury.
- The recommended viewing distance is at least 3 times of the image height. Do not view 3D images from a distance shorter than recommended.

Accessories

Standard accessories

Remote Control

➔ (p. 22)

- N2QAYB001119
or N2QAYB001133



Pedestal

50-inch model 58-inch model 65-inch model

➔ (p. 7)

75-inch model

➔ (p. 14)

Cable clamp

➔ (p. 19)



50-inch model 58-inch model 65-inch model

Cable tie (3)

➔ (p. 19)

75-inch model

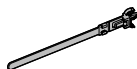

Cable tie (4)

➔ (p. 19)

50-inch model 58-inch model

Cable band (2)

➔ (p. 20)

Assembly screw (2)

M4 × 5.5 (mm)

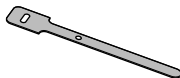

Batteries (2)

- R6

➔ (p. 23)



Operating Instructions

- Accessories may not be placed all together. Take care not to throw them away unintentionally.

Optional accessories

3D Eyewear

- If you need 3D Eyewear, please purchase Panasonic optional accessories.
- Use Panasonic 3D Eyewear supporting Bluetooth wireless technology for active shutter 3D.
- For information about 3D Eyewear (English only): <http://panasonic.jp/support/global/cs/tv/>

Assembling / Removing the pedestal

50-inch model 58-inch model 65-inch model

A Assembly screw (10)



M4 × 12 (mm)

B Assembly screw (2)



M5 × 15 (mm)

C Main bracket

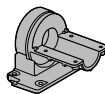

D Pole

50-inch model 58-inch model

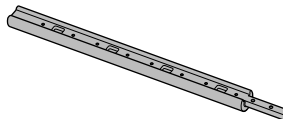

65-inch model

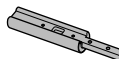

E Support bracket



F Base

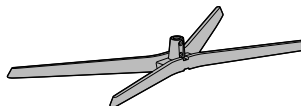

© Cover

50-inch model

58-inch model

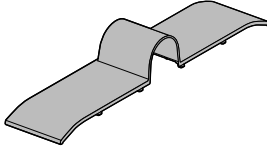

65-inch model

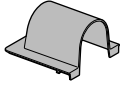

About the pedestal height

50-inch model

58-inch model

- Select a pedestal height from the following 4 types.
- The pedestal height can be changed according to step 2 in "Assembling the pedestal". (p. 9)
- For each dimension, refer to "Specifications". (p. 29)

High

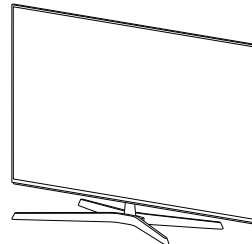
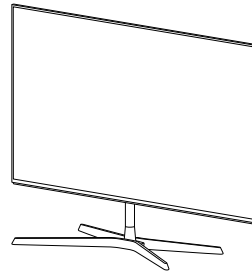
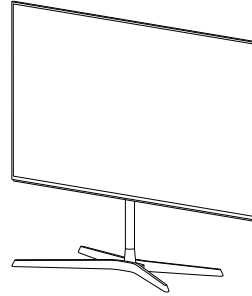
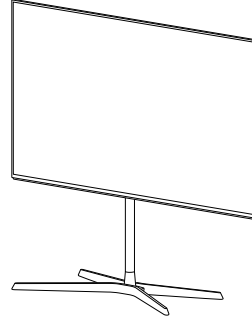

Low

Preparations

Take out the pedestal and the TV from the packing case and put the TV onto a work table with the screen panel down on the clean and soft cloth (blanket, etc.)

- Use a flat and firm table bigger than the TV.
- Do not hold the screen panel part.
- Make sure not to scratch or break the TV.

Assembling the pedestal

50-inch model 58-inch model

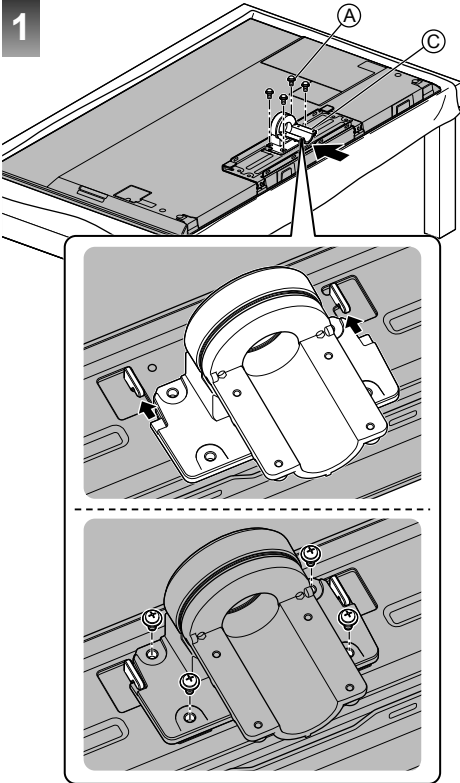

2

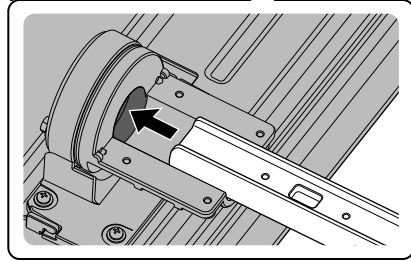
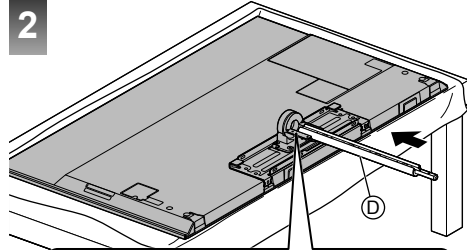

High

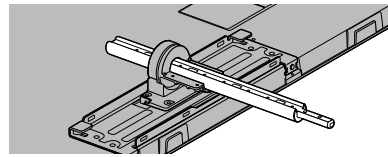
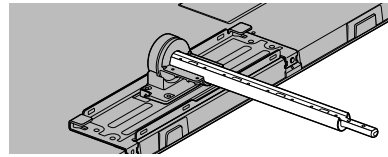

Low

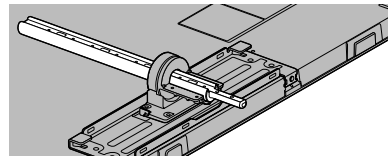
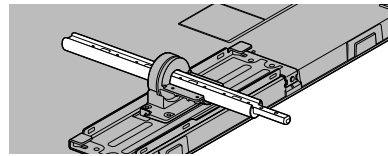

3

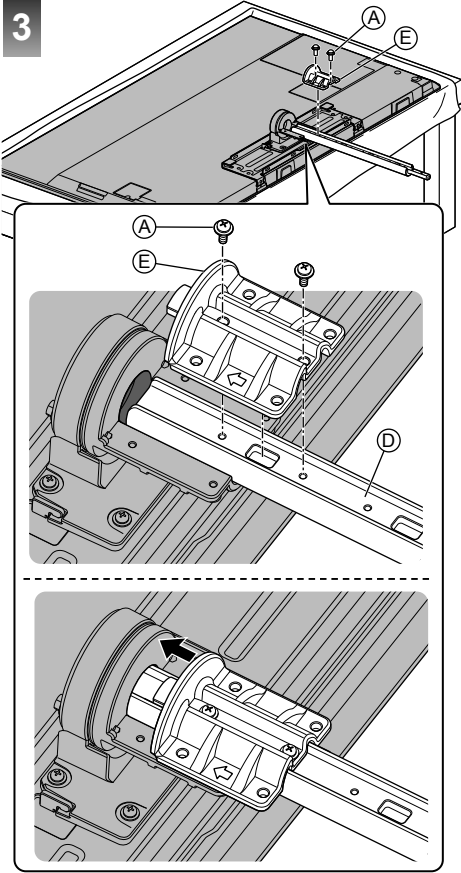

4

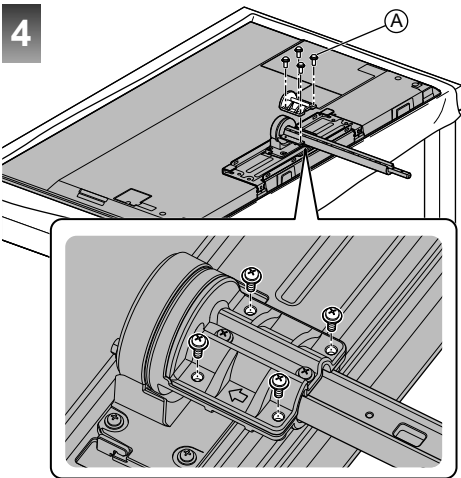

5

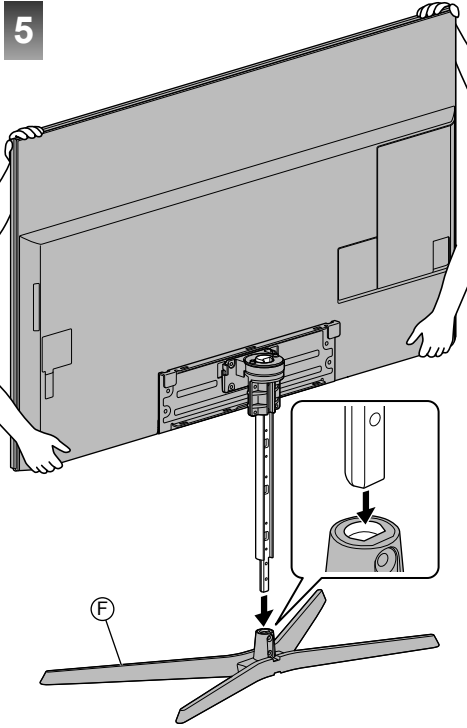

6

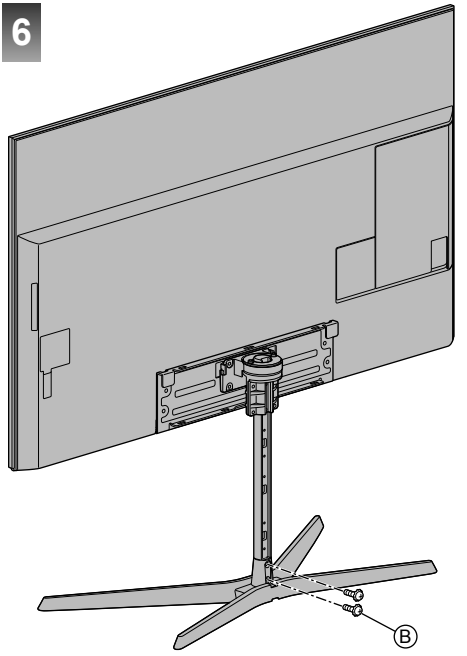

7

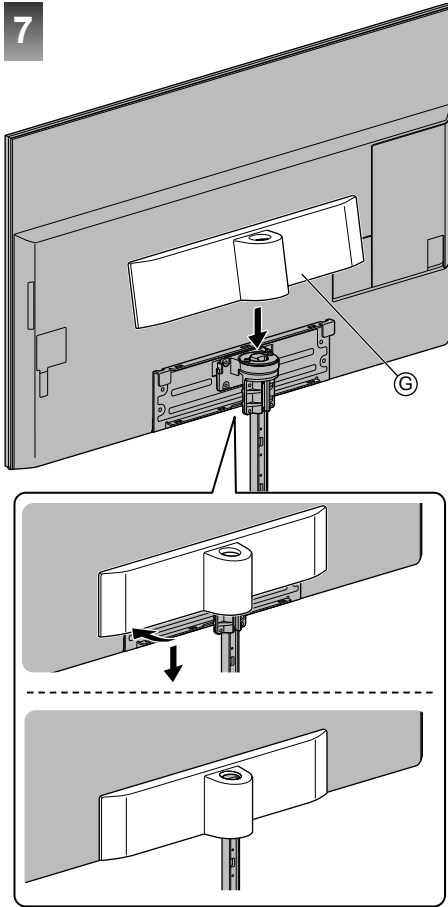

Assembling the pedestal

65-inch model

1

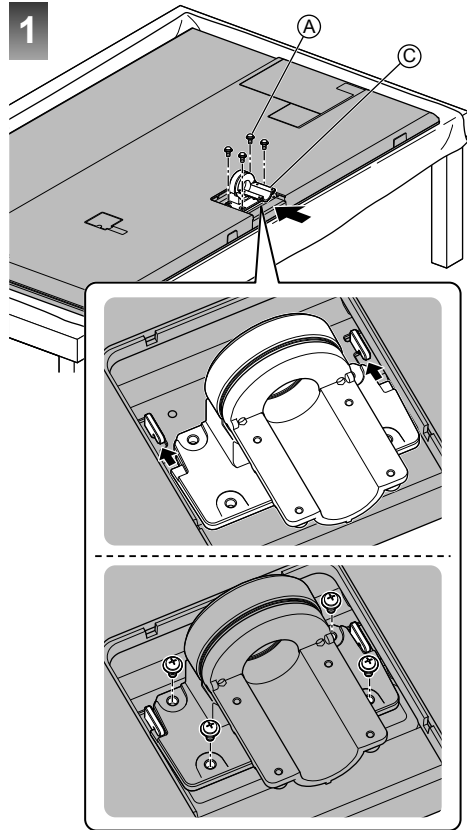

■ To change the height

Be sure to perform the following procedures when you change the height after assembling the pedestal.

- 1 Remove the cover (G).
- 2 Remove the assembly screws (B) from the base.
- 3 Lift the TV and pull out the pole from the base.
- 4 Put the TV onto a work table with the screen panel down on the clean and soft cloth.
- 5 Remove the assembly screws (A) from the support bracket.
- 6 Pull out the pole from the main bracket.
- 7 Remove the support bracket.
- 8 Change the height. (p. 9)
- 9 Use the assembly screws (A) to fasten the support bracket (B) to the pole (D) securely.
- 10 Assemble the pedestal according to steps 2 to 5 in "Assembling the pedestal". (p. 9)

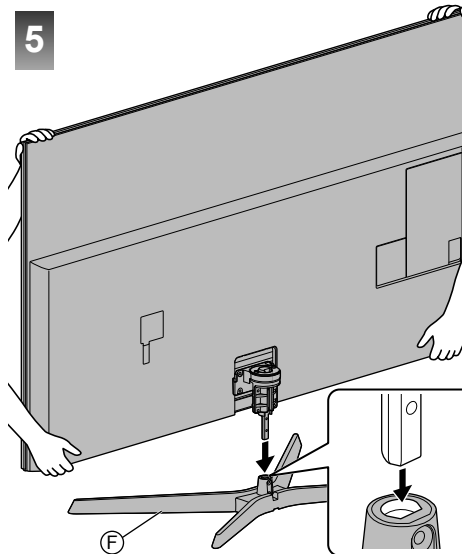
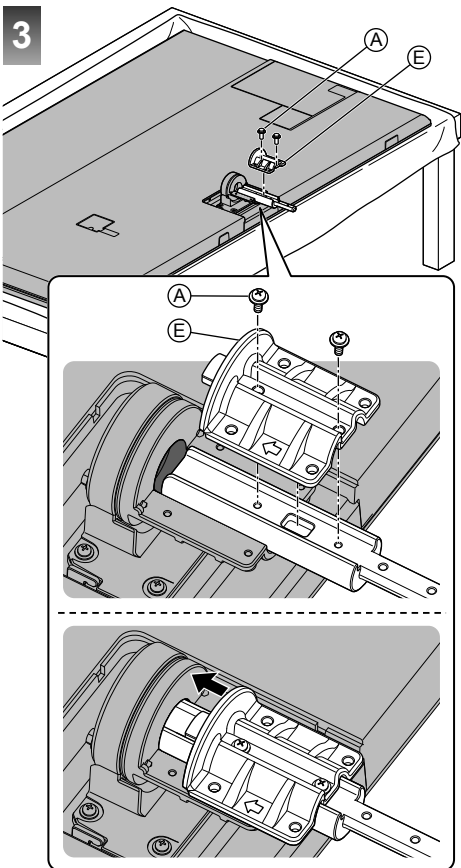
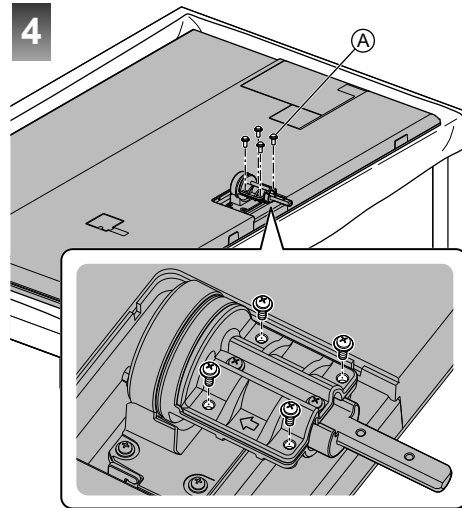
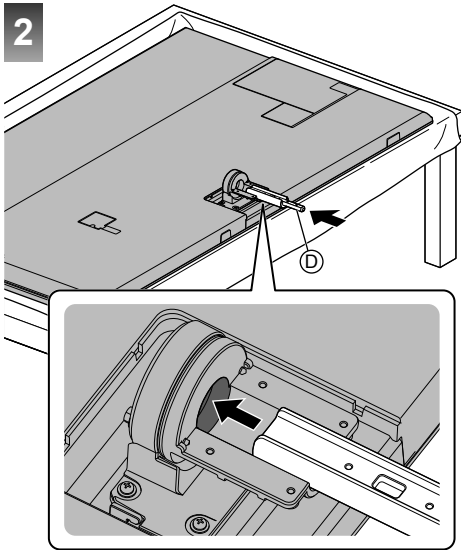

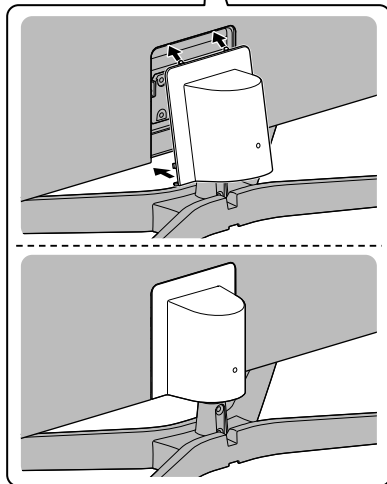
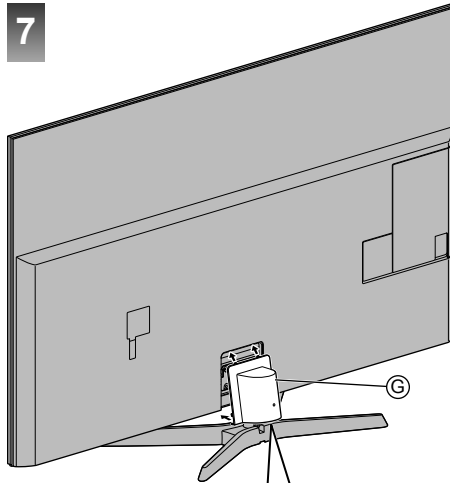
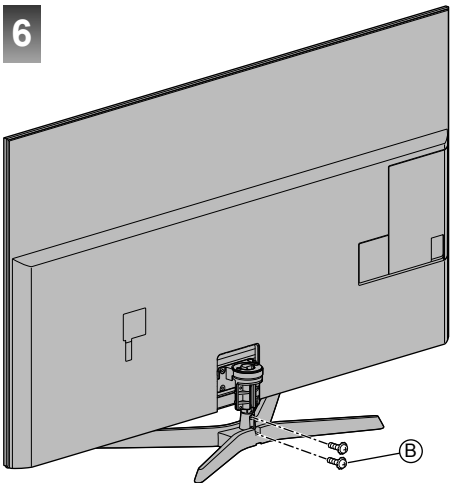

Adjusting the panel to your desired angle

50-inch model 58-inch model 65-inch model

- Do not place any objects within the full rotation range.

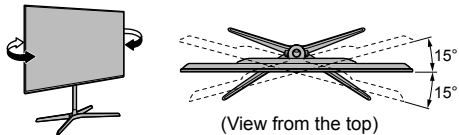

Removing the pedestal

Be sure to remove the pedestal in the following procedures when you repack the TV.

- 1 Remove the cover ③.
- 2 Remove the assembly screws ② from the base.
- 3 Lift the TV and pull out the pole from the base.
- 4 Put the TV onto a work table with the screen panel down on the clean and soft cloth.
- 5 Remove the assembly screws ① from the support bracket.
- 6 Pull out the pole from the main bracket.
- 7 Remove the assembly screws ④ from the main bracket.
- 8 Remove the main bracket.

50-inch model 58-inch model

■ When using the wall-hanging bracket

In addition to removing the pedestal, removing the following back bracket ① is needed.

- 9 Remove the assembly screws ⑤ / ⑥ from the back bracket ①.
- 10 Remove the back bracket ①.
- 11 Remove the assembly screws ④.

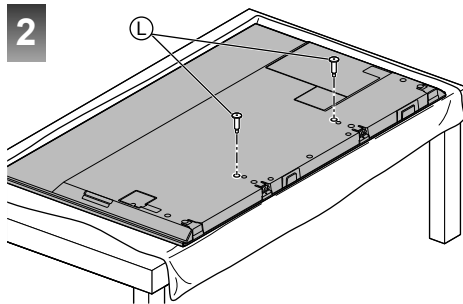
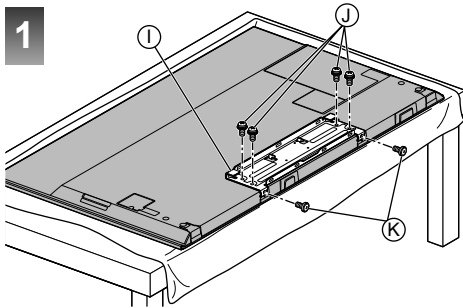

Assembling / Removing the pedestal

75-inch model

① Assembly screw (4)

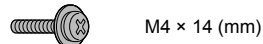

② Pedestal

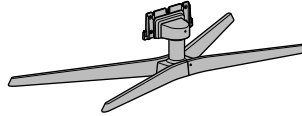

③ Cover

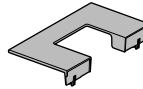

Assembling the pedestal

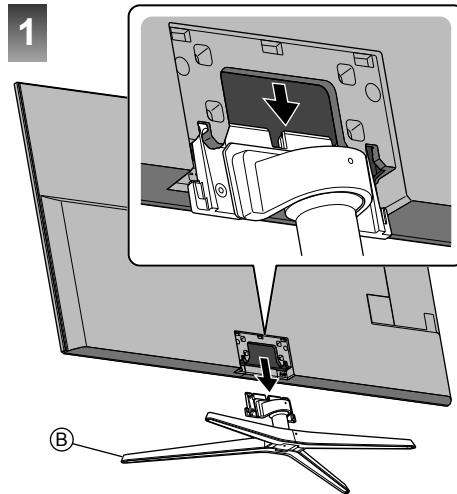

2

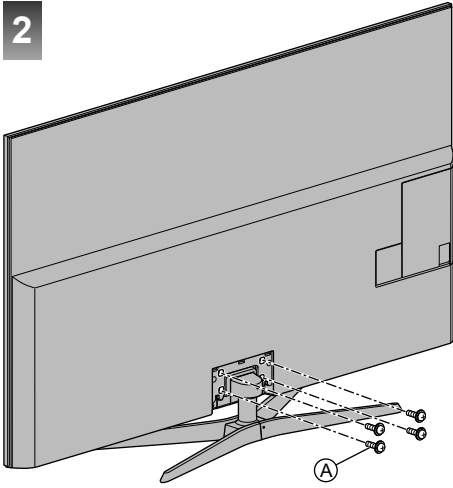

3

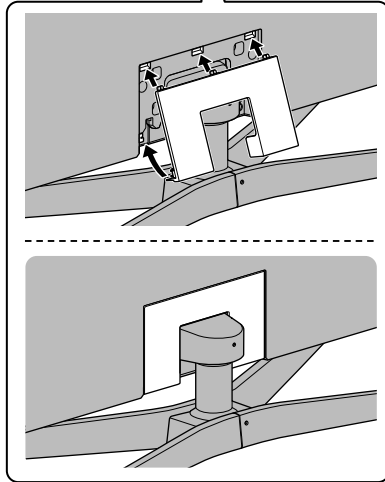
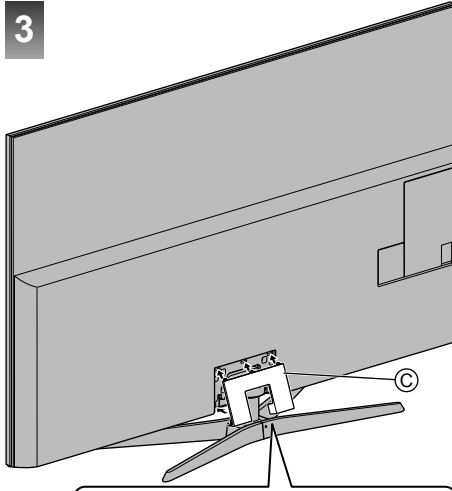

Removing the pedestal

Be sure to remove the pedestal in the following procedures when you use the wall-hanging bracket or repack the TV.

- 1 Remove the cover ©.
- 2 Remove the assembly screws Ⓐ from the pedestal.
- 3 Pull out the pedestal from the TV.

Connections

- External equipment and cables shown are not supplied with this TV.
- Please ensure that the unit is disconnected from the mains socket before attaching or disconnecting any cables.
- Check the terminal type and cable plugs are correct for connection.
- Use a fully wired HDMI compliant cable.
- Keep the TV away from electronic equipment (video equipment, etc.) or equipment with an infrared sensor, otherwise distortion of image / sound may occur or operation of other equipment may be affected.
- Please also read the manual of the equipment being connected.

Removing the cable cover / terminal cover from the TV

- Be sure to remove the cable cover / terminal cover before connecting or disconnecting cables.
- When the connections are completed, attach the cable cover / terminal cover. ➔ (p. 20)

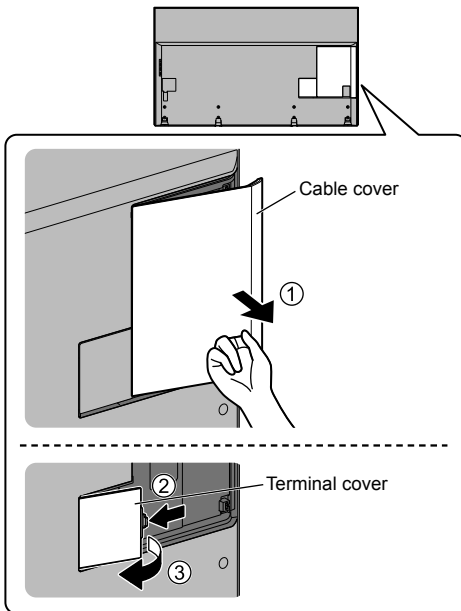

Terminals

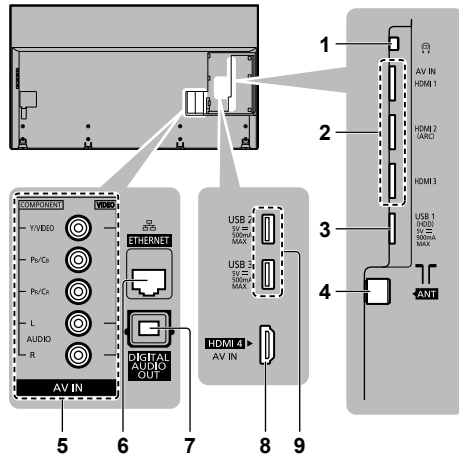

- 1 Headphone jack ➔ (p. 18)
- 2 HDMI 1 - 3 ➔ (p. 17, 18)
- 3 USB 1 port
- 4 Aerial terminal ➔ (p. 16)
- 5 AV IN (COMPONENT / VIDEO) ➔ (p. 18)
- 6 ETHERNET terminal ➔ (p. 17)
- 7 DIGITAL AUDIO OUT
- 8 HDMI 4
- 9 USB 2 - 3 port
 - To watch content in 4K format, use HDMI terminal. ➔ (p. 17)

Basic connections

■ Mains lead

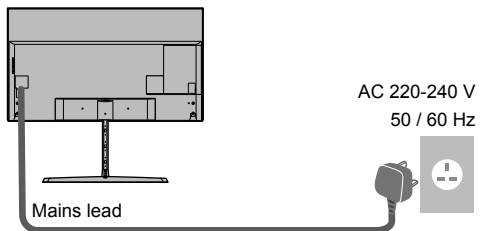

■ Aerial

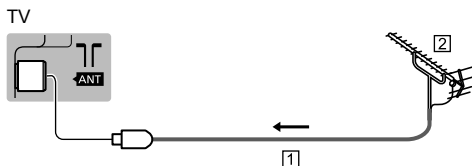

- 1 RF cable
- 2 Aerial

- For Digital TV, Analogue TV
- Keep RF (aerial) cable away from the mains lead to avoid and minimise mains interference pickup.
- Do not place the RF cable under the TV.
- An aerial, correct cable (75 Ω coaxial) and correct terminating plug are required to obtain optimum quality picture and sound.
- If a communal aerial system is used, you may require the correct connection cable and plug between the wall aerial socket and the TV.
- Your local Television Service Centre or dealer may be able to assist you in obtaining the correct aerial system for your particular area and the accessories required.
- Any matters regarding aerial installation, upgrading of existing systems or accessories required, and the costs incurred, are the responsibility of you, the customer.

AV devices

■ DVD Recorder / Blu-ray Recorder, etc.

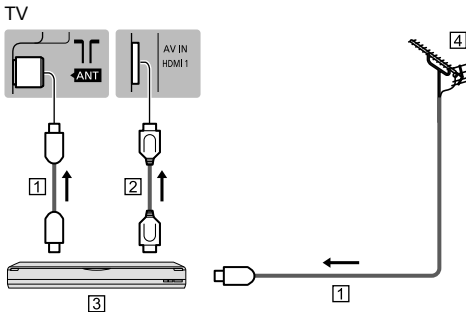

- ① RF cable
- ② HDMI cable
- ③ DVD Recorder / Blu-ray Recorder, etc.
- ④ Aerial

■ Set top box

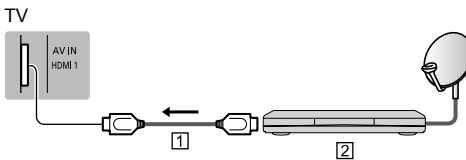

- ① HDMI cable
- ② Set top box

Network

A broadband network environment is required to be able to use internet services.

- If you do not have any broadband network services, please consult your retailer for assistance.
- Prepare the internet environment for wired connection or wireless connection.
- Setup of the network connection will start when first using the TV. ➔ (p. 24)

■ Wired connection

TV

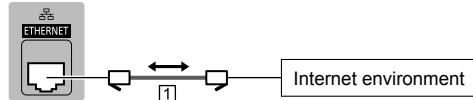

- ① LAN cable (Shielded)
 - Use Shielded Twist Pair (STP) LAN cable.

■ Wireless connection

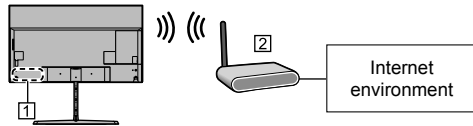

- ① Built-in wireless LAN
- ② Access point

Connections for 4K compatible equipment

TV

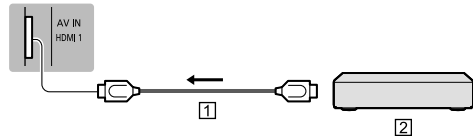

- ① HDMI cable
- ② 4K compatible equipment
 - To watch high-definition 4K more accurately or HDR content, connect the 4K compatible equipment to HDMI1 or 2 terminal.
 - Connect the 4K compatible equipment to HDMI terminal using a 4K compatible cable and you can watch content in 4K format.

■ [HDMI Auto Setting] (Setup Menu)

Reproduces the image more precisely with the expanded colour gamut when connecting the 4K compatible equipment. Select the mode depending on the equipment.

[Mode1]:

For better compatibility. Set to [Mode1] when the image or sound in HDMI input is not played properly.

[Mode2]:

For the 4K compatible equipment that has the function to output the image precisely with the expanded colour gamut

- To change the mode
 1. Select the HDMI input mode connected to the equipment.
 2. Display the menu and select [HDMI Auto Setting] (Setup Menu).
- For information about the valid format, refer to [eHELP] (Search by Purpose > Watching > 4K resolution > HDMI Auto Setting).

Other connections

■ DVD Player

(COMPONENT equipment)

TV

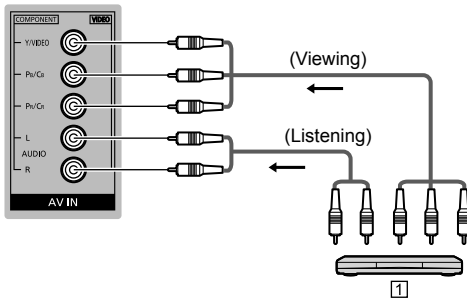

1 DVD Player

■ Camcorder / Game equipment

(VIDEO equipment)

TV

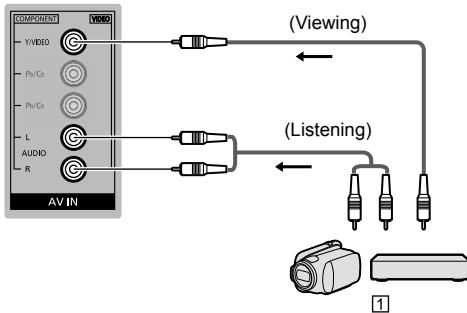

1 Camcorder / Game equipment

■ Amplifier (listening with external speakers)

- Use HDMI2 to connect the TV to an amplifier which has ARC (Audio Return Channel) function.

If connecting to an amplifier without ARC function, use DIGITAL AUDIO OUT.

- To enjoy multi-channel sound from external equipment (e.g. Dolby Digital 5.1ch), connect the equipment to the amplifier. For information about the connections, read the manuals of the equipment and amplifier.

TV

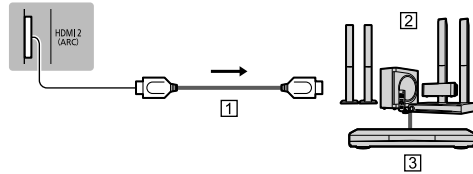

1 HDMI cable

2 Amplifier with speaker system

3 External equipment (DVD Player, etc.)

Note

- ARC function is not supported when performing mirroring on the TV set.

■ Headphones

- For information about the volume settings, refer to [eHELP] (Search by Purpose > Settings > Sound).

TV

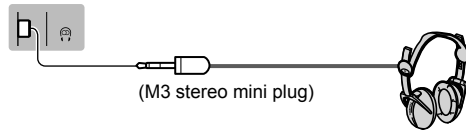

(M3 stereo mini plug)

■ USB HDD (for recording)

- Use USB 1 port for connecting the USB HDD.
- For details, refer to [eHELP] (Search by Purpose > Recording).

■ VIERA Link

- Use HDMI1 - 4 for VIERA Link connection.
- For details, refer to [eHELP] (Search by Purpose > Functions > VIERA Link "HDAVI Control™").

Cable arrangement

Fix the cables using the cable clamp, cable tie, etc. and then attach the cable cover / terminal cover to the TV.

■ Fixing the mains lead using the cable clamp

50-inch model 58-inch model

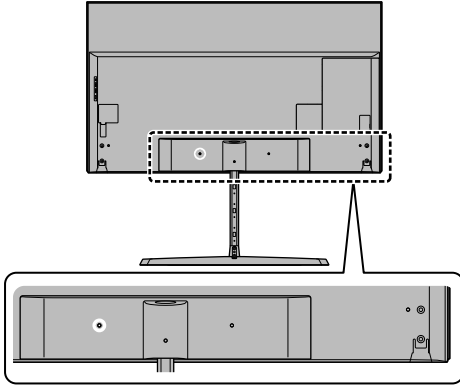

65-inch model

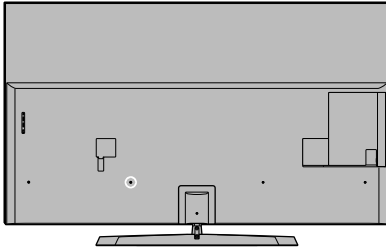

75-inch model

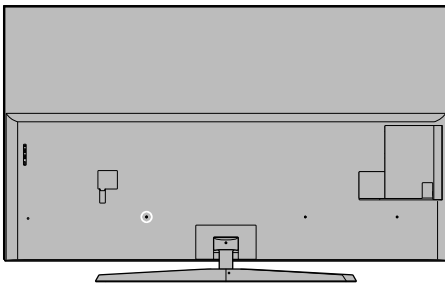

Attach the cable clamp

Insert the cable clamp in a hole

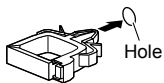

Bundle the cable

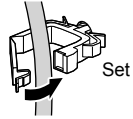

To release:

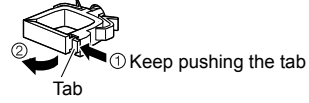

To remove from the TV:

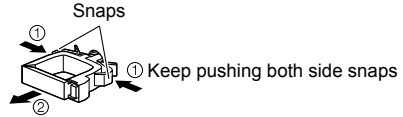

■ Fixing the cables using the cable tie

50-inch model 58-inch model

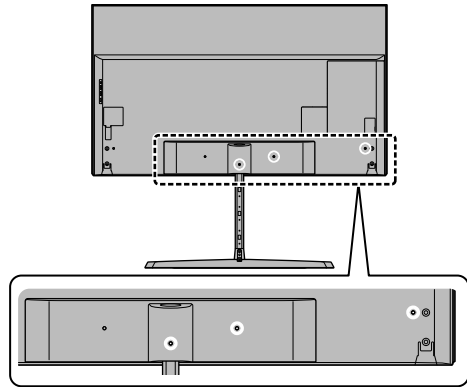

65-inch model

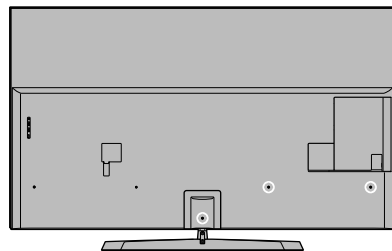

75-inch model

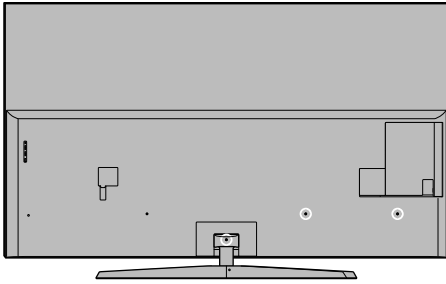

Attach the cable tie

Insert the cable tie in a hole

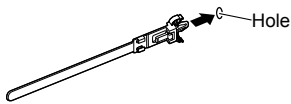

Bundle the cables

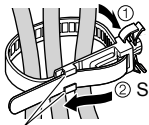

② Set the tip in the hooks

Hooks

To loosen:

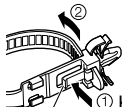

① Keep pushing the knob

Knob

To remove from the TV:

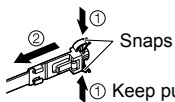

① Snaps

① Keep pushing both side snaps

50-inch model

58-inch model

■ Fixing the cables using the cable band

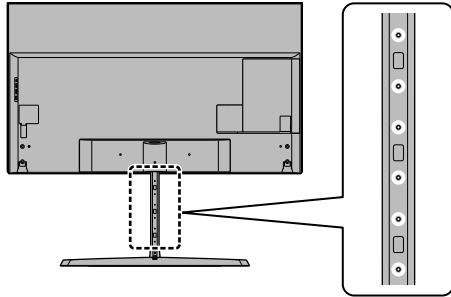

Attach the cable band

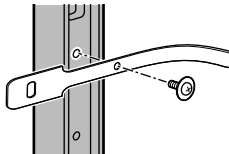

Bundle the cables



- Fix cables as necessary.
- When using the optional accessory, follow the option's assembly manual to fix cables.

■ Attaching the cable cover / terminal cover

- Do not apply load to the cable cover / terminal cover.
- Be careful not to nip the cables between the TV and the cable cover / terminal cover.
- When using USB 2 port, USB 3 port or HDMI4 terminal, you cannot attach the cable cover. Keep the removed cable cover for future use.
- When using AV terminal, ETHERNET terminal or DIGITAL AUDIO, you cannot attach the terminal cover. Keep the removed terminal cover for future use.

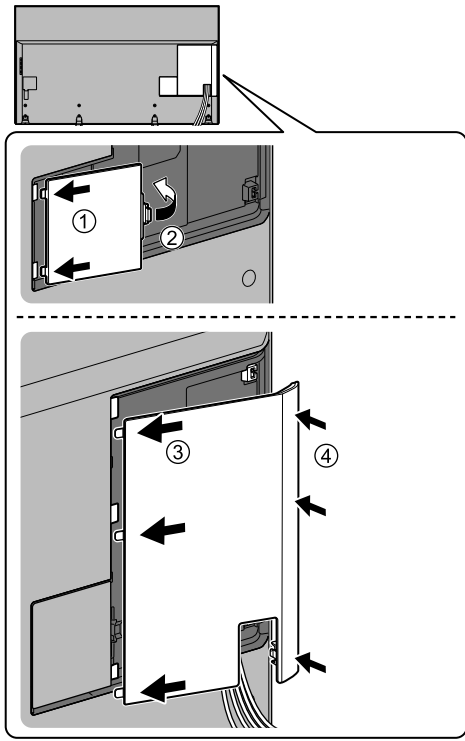

Identifying Controls

Remote Control

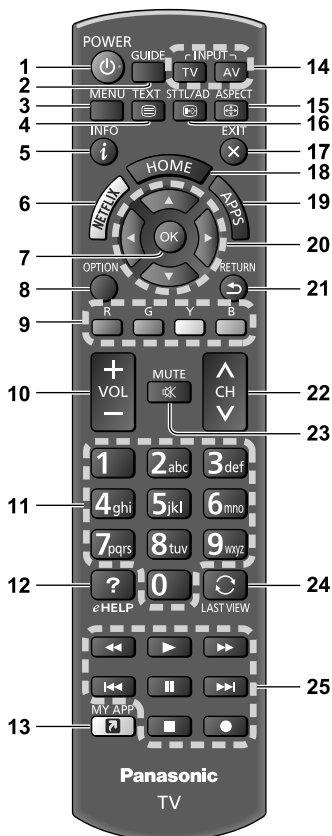

- 1 **[Power]**: Standby On / Off switch
- 2 **TV Guide**
- 3 **[Main Menu]**
 - Press to access Picture, Sound, Network, Timer, Setup and Help Menus, etc.
- 4 **Teletext button**
 - This button is not used for this model.
- 5 **Information**
 - Displays channel and programme information.
- 6 **Netflix**
 - Accesses NETFLIX service directly.
 - A broadband network environment is required in order to fully use this function.
 - This service may be stopped or changed without notice.

- 7 **OK**
 - Confirms selections and choices.
 - Press after selecting channel positions to quickly change channel.
 - Displays channel list.
- 8 **[Option Menu]**
 - Easy optional setting for viewing, sound, etc.
- 9 **Coloured buttons (red-green-yellow-blue)**
 - Used for the selection, navigation and operation of various functions.
- 10 **Volume Up / Down**
- 11 **Numeric buttons**
 - Changes channel.
 - Sets characters.
 - When in Standby mode, switches TV on.
- 12 **[eHELP]**
 - Displays [eHELP] (Built-in Operating Instructions).
- 13 **[My App]**
 - Assigns a favourite application. After setting, starts the application easily by pressing this button.
 - For details, refer to [eHELP] (Search by Purpose > Home Screen > Apps > My App)
- 14 **Input mode selection**
 - TV - switches to Digital TV / Analogue TV.
 - AV - switches to AV input mode from Input Selection list.
- 15 **Aspect**
 - Changes aspect ratio.
- 16 **Subtitles**
 - Displays subtitles.
- 17 **Exit**
 - Returns to the normal viewing screen.
- 18 **HOME**
 - Displays [Home Screen].
 - For details, refer to [eHELP] (Search by Purpose > Read first > Features).
- 19 **APPS**
 - Displays [Apps] (applications list).
- 20 **Cursor buttons**
 - Makes selections and adjustments.
- 21 **Return**
 - Returns to the previous menu / page.
- 22 **Channel Up / Down**
- 23 **Sound Mute On / Off**
- 24 **Last view**
 - Switches to previously viewed channel or input mode.
- 25 **Operations for contents, connected equipment, etc.**

■ Installing / Removing batteries

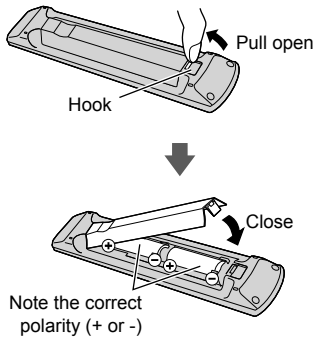

Indicator / Control panel

- When pressing 4, 5, 6 buttons, the control panel guide appears on the right side of the screen for 3 seconds to highlight which button has been pressed.

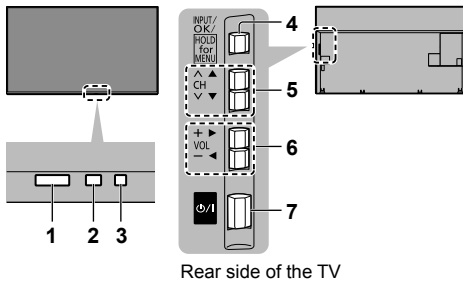

1 Remote control signal receiver

- Do not place any objects between the TV remote control signal receiver and remote control.

2 Ambient sensor

- Senses brightness to adjust picture quality when [Ambient Sensor] in the Picture Menu is set to [On].

3 Power LED

Red: Standby

Green: On

Orange: Standby with some functions (recording, etc.) active

- The LED blinks when the TV receives a command from the remote control.

4 Input mode selection

- Press repeatedly until you reach the desired mode.

[Main Menu]

- Press and hold for about 3 seconds to display main menu.

OK (when in the menu system)

5 Channel Up / Down

- Cursor Up / Down (when in the menu system)

6 Volume Up / Down

- Cursor Left / Right (when in the menu system)

7 Mains power On / Off switch

- Use to switch the mains power.
- To turn Off the apparatus completely, you must pull the mains plug out of the mains socket.
- **[⏻/⏻]**: Standby / On

First time Auto Tuning

When the TV is turned on for the first time, it will automatically search for available TV channels and give options to set up the TV.

- These steps are not necessary if the setup has been completed by your local dealer.
- Please complete connections (p. 16 - 21) and settings (if necessary) of the connected equipment before starting Auto Tuning. For information about the settings for the connected equipment, read the manual of the equipment.

1 Plug the TV into a live mains socket and turn the power on

POWER • Takes a few seconds to be displayed.

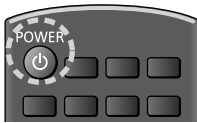

2 Select the following items

Set up each item by following the on-screen instructions.

Example:

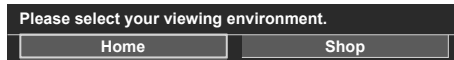

■ How to use the remote control



Move the cursor



Access the item / store the setting



Return to the previous item (if available)

Select the language

Select [Home]

Select [Home] for use in a home viewing environment.

- [Shop] is for shop display.
- To change the viewing environment later on, the set will need to have all settings initialised by accessing Shipping Condition.

Set up the network connection

Tick the TV signal mode to tune, and then select [Start Auto Tuning]

- : tune (search for the available channels)
- : skip tuning

■ When you select the analogue TV signal, select your area.

- When selecting [CATV/Other], press the OK button, and then select the Channel Plan from Indian CATV, South Africa, American System, American CATV or Japan CATV.

Auto Tuning is now complete and the TV is ready for viewing.

If tuning has failed check the RF cable, and the network connection, and then follow the on-screen instructions.

Note

- The TV goes into Standby mode when no operation is performed for 4 hours if [Auto Standby] in the Timer Menu is set to [On].
- The TV goes into Standby mode when no signal is received and no operation is performed for 10 minutes if [No signal Power off] in the Timer Menu is set to [On].
- To retune all channels
 - ➔ [Auto Tuning] in [Tuning Menu] (Setup Menu)
- To add the available TV signal mode later
 - ➔ [Add TV Signal] in [Tuning Menu] (Setup Menu)
- To initialise all settings
 - ➔ [Shipping Condition] in [System Menu] (Setup Menu)

Watching TV

1 Turn power on

 (TV)

or

POWER



(Remote Control)

- Mains power On / Off switch should be on. (p. 23)

Displays information bar on the edge of screen for several seconds.

- For information about the operation and settings, refer to [eHELP]. (Search by Purpose > Read first > Features)

2 Select Digital TV or Analogue TV

 TV

3 Select a channel

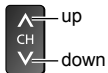

or



- To select a channel position with 2 or more-digit, e.g. 399



How to Use eHELP

[eHELP] is the detailed operating instructions built into the TV, and gives a more detailed explanation for a better understanding of the operation of each feature.

1 Display [eHELP]



eHELP

or

MENU



[Help]



[eHELP]

- If the [eHELP] has been accessed previously since the TV was turned on, the confirmation screen is displayed to select whether to go to the [First page] or to the [Last viewed page].

2 Select the menu

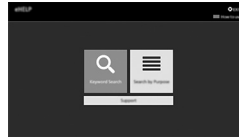

① select

② access

- To access [How to use]

G

 (green)

[Keyword Search]:

Search the content of eHELP in the keyword.

[Search by Purpose]:

Search the content of eHELP for each item.

[Support]:

Access the support information (FAQs, etc.).

3 Select the item

Example:



① select

② access

- To return to the previous screen / field

RETURN



- To scroll the description (if more than 1 page)
While the description is highlighted



- To open the reference screen ( →)



- To display the menu related to the description (only for some descriptions)



- To check the features of this TV

Search by Purpose > Read first > Features

Viewing 3D images

You can enjoy viewing 3D images of content or programmes supporting 3D effects by wearing the 3D Eyewear (optional).

- The 3D Eyewear must be worn to view 3D images.
- When using the 3D Eyewear, please also read the manual of the 3D Eyewear.
- This TV supports [Frame Sequential]*, [Side by Side] and [Top and Bottom] 3D formats. (3D content in 4K format is not supported.)
- For details, refer to [eHELP] (Search by Purpose > Watching > 3D).

*:Frame Sequential is the 3D format that the images for right and left eyes are recorded with high definition quality and alternately played back.

To view the 3D images

- Use Panasonic 3D Eyewear supporting Bluetooth wireless technology for active shutter 3D.
- **Playing back 3D-compatible Blu-ray disc (Frame Sequential format)**
- Connect the 3D-compatible player via a fully wired HDMI compliant cable. (If you use the non 3D-compatible player, the images will be displayed in 2D mode.)
 - If the input mode is not switched automatically, select the input mode connected to the player using the AV button.
- **3D-supported broadcast**
- Please consult the suppliers of content or programmes for availability of this service.
- **3D photos and 3D videos taken by 3D-compatible Panasonic products**
- Available in Media Player and Network services.
- **2D images converted to 3D**
- Set to [2D→3D] mode in [3D Mode Selection] ([Picture] > [3D Settings] > [3D Mode]). (Content in 4K format cannot be converted to 3D mode.)

Ensure that the registration of the 3D Eyewear has been completed. For details, read the manual of the 3D Eyewear.

1 Turn the 3D Eyewear on and put it on

Connection status and battery status are displayed on the bottom right of the screen.

2 View the 3D images

Safety precautions will be displayed when you first watch the 3D image. Select [Yes] or [No] to continue to view 3D images.

Note

- Turn off the 3D Eyewear after using it.
- Use the 3D Eyewear within approximately 3.2 m from the TV. You cannot view the 3D images with the 3D Eyewear too far from the TV, because of the difficulty of receiving radio waves from the TV.
- The range may be shortened depending on the obstacles between the TV and the 3D Eyewear, or the surrounding environment.
- When viewing 3D images, make sure your eyes are in a horizontal position where double vision does not occur.
- If the room is lit by fluorescent lights (50 Hz) and light appears to flicker when using the 3D Eyewear, switch off the fluorescent light.
- There are differences in the viewing range of the 3D Eyewear among individuals.

FAQs

Before requesting service or assistance, please follow these simple guides to solve the problem.

- For details, refer to [eHELP] (Support > FAQs).
-

The TV does not switch on

- Check the mains lead is plugged into the TV and the mains socket.
-

The TV goes into Standby mode

- Auto power standby function is activated.
-

The remote control does not work or is intermittent

- Are the batteries installed correctly? ➔ (p. 23)
 - Has the TV been switched on?
 - The batteries may be running low. Replace them with new ones.
 - Point the remote control directly at the TV's remote control signal receiver (within about 7 m and a 30 degree angle of the signal receiver).
 - Situate the TV away from sunshine or other sources of bright light so they do not shine on the TV's remote control signal receiver.
-

No image is displayed

- Check the TV is turned on.
 - Check the mains lead is plugged into the TV and the mains socket.
 - Check the correct input mode is selected.
 - Check the setting of [AV] ([COMPONENT] / [VIDEO]) in [Input Selection] to match the signal being output by the external equipment.
 - Is [Backlight], [Contrast], [Brightness] or [Colour] in the Picture Menu set to the minimum?
 - Check all required cables and connections are firmly in place.
-

An unusual image is displayed

- This TV has a built-in Self Test. Makes a diagnosis of picture or sound problems.
➔ [TV Self Test] (Help Menu)
 - Turn the TV off with Mains power On / Off switch, then turn it on again.
 - If the problem persists, initialise all settings.
➔ [Shipping Condition] in [System Menu] (Setup Menu)
-

The image or sound from external equipment are unusual when the equipment is connected via HDMI

- Set [HDMI Auto Setting] (Setup Menu) to [Mode1]
➔ (p. 17)
-

Parts of the TV become hot

- Parts of the TV may become hot. These temperature rises do not pose any problems in terms of performance or quality.
-

When pushed with a finger, the display panel moves slightly and makes a noise

- There is a little gap around the panel to prevent damage to the panel. This is not a malfunction.

Maintenance

First, remove the mains plug from the mains socket.

Display panel, Cabinet, Pedestal

Regular care:

Gently wipe the surface of the display panel, cabinet, or pedestal by using a soft cloth to remove dirt or fingerprints.

For stubborn dirt:

- (1) First clean the dust from the surface.
- (2) Dampen a soft cloth with clean water or diluted neutral detergent (1 part detergent to 100 parts water).
- (3) Wring out the cloth firmly. (Please note, do not let liquid enter the TV inside as it may lead to product failure.)
- (4) Carefully wipe moisten and wipe away the stubborn dirt.
- (5) Finally, wipe away all the moisture.

Caution

- Do not use a hard cloth or rub the surface too hard, otherwise this may cause scratches on the surface.
- Take care not to subject the surfaces to insect repellent, solvent, thinner or other volatile substances. This may degrade surface quality or cause peeling of the paint.
- The surface of the display panel is specially treated and may be easily damaged. Take care not to tap or scratch the surface with your fingernail or other hard objects.
- Do not allow the cabinet and pedestal to make contact with a rubber or PVC substance for a long time. This may degrade surface quality.

Mains plug

Wipe the mains plug with a dry cloth at regular intervals. Moisture and dust may cause fire or electrical shock.

Specifications

■ TV

Model No.

50-inch model	: TH-50EX750H
58-inch model	: TH-58EX750H
65-inch model	: TH-65EX750H
75-inch model	: TH-75EX750H

Dimensions (W × H × D)

50-inch model

With Pedestal

(listed in order of height)

- 1 115 mm × 997 mm × 348 mm
- 1 115 mm × 907 mm × 348 mm
- 1 115 mm × 817 mm × 348 mm
- 1 115 mm × 727 mm × 348 mm

TV only

- 1 115 mm × 647 mm × 40 mm

58-inch model

With Pedestal

(listed in order of height)

- 1 290 mm × 1 103 mm × 446 mm
- 1 290 mm × 1 013 mm × 446 mm
- 1 290 mm × 923 mm × 446 mm
- 1 290 mm × 833 mm × 446 mm

TV only

- 1 290 mm × 753 mm × 41 mm

65-inch model

With Pedestal

- 1 457 mm × 921 mm × 446 mm

TV only

- 1 457 mm × 841 mm × 52 mm

75-inch model

With Pedestal

- 1 680 mm × 1 046 mm × 413 mm

TV only

- 1 680 mm × 966 mm × 70 mm

Mass

50-inch model

- 22.5 kg Net (With Pedestal)
- 16.0 kg Net (TV only)

58-inch model

- 30.5 kg Net (With Pedestal)
- 24.0 kg Net (TV only)

65-inch model

- 43.5 kg Net (With Pedestal)
- 39.0 kg Net (TV only)

75-inch model

62.5 kg Net (With Pedestal)
54.0 kg Net (TV only)

Power source

AC 220-240 V, 50 / 60 Hz

Rated power consumption**50-inch model**

149 W

58-inch model

182 W

65-inch model

196 W

75-inch model

231 W

Standby power consumption

0.50 W

Visible screen size (diagonal)**50-inch model**

126 cm

58-inch model

146 cm

65-inch model

164 cm

75-inch model

189 cm

Display resolution

3 840 (W) × 2 160 (H)

Panel

LED backlight Liquid Crystal Display

Sound**Speaker output**

20 W (10 W + 10 W)

Headphones

M3 (3.5 mm) stereo mini Jack × 1

Connection terminals**AV IN (COMPONENT / VIDEO)****VIDEO**

RCA PIN Type × 1

1.0 V[p-p] (75 Ω)

AUDIO L - R

RCA PIN Type × 2

0.5 V[rms]

Y

1.0 V[p-p] (including synchronisation)

PB/CB, PR/CR

±0.35 V[p-p]

HDMI 1 / 2 / 3 / 4 input

TYPE A Connectors

HDMI1 / 3 / 4: 4K, 3D (3D content of 4K format is not supported.), Content Type, Deep Colour, x.v.Colour™

HDMI2: 4K, 3D (3D content of 4K format is not supported.), Content Type, Audio Return Channel, Deep Colour, x.v.Colour™

- This TV supports "HDMI Control 5" function.

ETHERNET

10BASE-T / 100BASE-TX

USB 1 / 2 / 3

USB1: DC ≐ 5 V, Max. 900 mA [SuperSpeed USB (USB 3.0)]

USB2 / 3: DC ≐ 5 V, Max. 500 mA [Hi-Speed USB (USB 2.0)]

DIGITAL AUDIO OUT

PCM / Dolby Digital, Fibre optic

Receiving systems / Band name

17 Systems		Function
1	PAL B, G, H	Reception of broadcast transmissions and Playback from Video Cassette Tape Recorders
2	PAL I	
3	PAL D, K	
4	SECAM B, G	
5	SECAM D, K	
6	SECAM K1	
7	NTSC M (NTSC 3.58/4.5 MHz)	Playback from Special VCR's or DVD
8	NTSC 4.43/5.5 MHz	
9	NTSC 4.43/6.0 MHz	
10	NTSC 4.43/6.5 MHz	
11	NTSC 3.58/5.5 MHz	
12	NTSC 3.58/6.0 MHz	
13	NTSC 3.58/6.5 MHz	
14	SECAM I	Playback from Special Disc Players and Special VCR's or DVD
15	PAL 60 Hz/5.5 MHz	
16	PAL 60 Hz/6.0 MHz	
17	PAL 60 Hz/6.5 MHz	

Digital terrestrial TV

GB20600-2006 free-to-air TV broadcast reception

Receiving channels (Analogue TV)

VHF BAND

- 2-12 (PAL/SECAM B, K1)
- 0-12 (PAL B AUST.)
- 1-9 (PAL B N.Z.)
- 1-12 (PAL/SECAM D)
- 1-12 (NTSC M Japan)
- 2-13 (NTSC M USA)

UHF BAND

- 21-69 (PAL G, H, I/SECAM G, K, K1)
- 28-69 (PAL B AUST.)
- 13-57 (PAL D, K)
- 13-62 (NTSC M Japan)
- 14-69 (NTSC M USA)

CATV

- S1-S20 (OSCAR)
- 1-125 (USA CATV)
- C13-C49 (JAPAN)
- S21-S41 (HYPER)
- Z1-Z37 (CHINA)
- 5A, 9A (AUST.)

Aerial input

VHF / UHF

Operating conditions

Temperature

0 °C - 40 °C

Humidity

20 % - 80 % RH (non-condensing)

Built-in wireless LAN

Standard compliance and Frequency range*1

- IEEE802.11a/n
- 5.15 GHz - 5.35 GHz, 5.47 GHz - 5.85 GHz
- IEEE802.11b/g/n
- 2.400 GHz - 2.4835 GHz

Security

- WPA2-PSK (TKIP/AES)
- WPA-PSK (TKIP/AES)
- WEP (64 bit/128 bit)

Bluetooth wireless technology*2

Standard Compliance

Bluetooth 3.0

Frequency Range

2.402 GHz - 2.480 GHz

*1: The frequency and channel differ depending on the country.

*2: Not all the Bluetooth compatible devices are available with this TV. Up to 5 devices can be used simultaneously (except the 3D Eyewear).

Note

- Design and Specifications are subject to change without notice. Mass and Dimensions shown are approximate.
- For information about the open source software, refer to [eHELP] (Search by Purpose > Read first > Before use > Licence).
- TH-50EX750H / TH-58EX750H / TH-65EX750H / TH-75EX750H complies with China Terrestrial Television National Standard (GB20600-2006) Mode-C=3780.

■ When using the wall-hanging bracket

50-inch model 58-inch model

- 1 Remove the assembly screws ① / ② from the back bracket ③.
- 2 Remove the back bracket ④.
- 3 Remove the assembly screws ⑤.

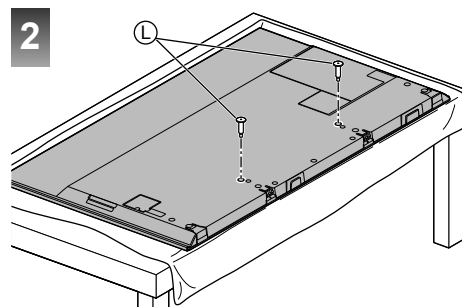
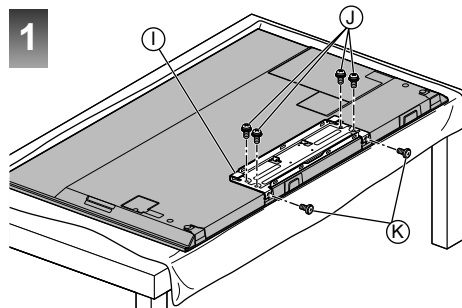

Please contact your local Panasonic dealer to purchase the recommended wall-hanging bracket.

- Holes for wall-hanging bracket installation
Rear of the TV

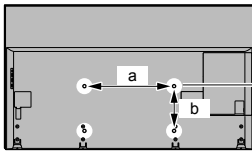

50-inch model

58-inch model

65-inch model

a: 400 mm

b: 200 mm

75-inch model

a: 600 mm

b: 300 mm

(View from the side)

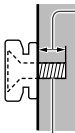

Depth of screw

50-inch model

minimum: 10 mm

maximum: 15 mm

Diameter: M6

58-inch model

minimum: 10 mm

maximum: 17 mm

Diameter: M6

65-inch model

minimum: 9 mm

maximum: 30 mm

Diameter: M6

75-inch model

minimum: 11 mm

maximum: 30 mm

Diameter: M8

Screw for fixing the TV onto the wall-hanging bracket (not supplied with the TV)

Warning

- Using other wall-hanging brackets, or installing a wall-hanging bracket by yourself have the risk of personal injury and product damage. In order to maintain the unit's performance and safety, be absolutely sure to ask your dealer or a licensed contractor to secure the wall-hanging brackets. Any damage caused by installing without a qualified installer will void your warranty.
- Carefully read the instructions accompanying optional accessories, and be absolutely sure to take steps to prevent the TV from falling off.
- Handle the TV carefully during installation since subjecting it to impact or other forces may cause product damage.
- Take care when fixing wall brackets to the wall. Always ensure that there are no electrical cables or pipes in the wall before hanging bracket.
- To prevent fall and injury, remove the TV from its fixed wall position when it is no longer in use.

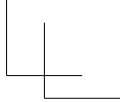
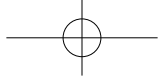
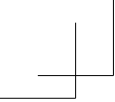

A series of 20 horizontal dashed lines spanning the width of the page, intended for handwriting practice.

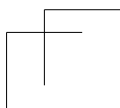
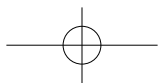
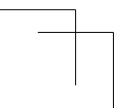
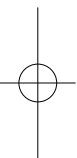

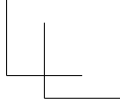
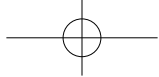
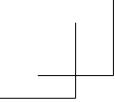

A series of 20 horizontal dashed lines spanning the width of the page, intended for handwriting practice.

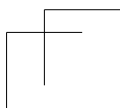
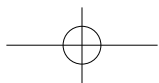
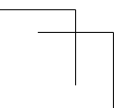
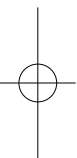

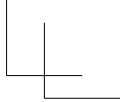
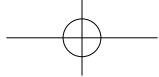
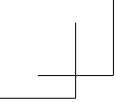

A series of 18 horizontal dashed lines spanning the width of the page, intended for handwriting practice.

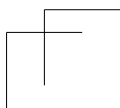
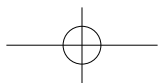
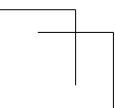
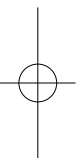

Information on Disposal in other Countries outside the European Union



This symbol is only valid in the European Union. If you wish to discard this product, please contact your local authorities or dealer and ask for the correct method of disposal.



Customer's Record

The model number and serial number of this product may be found on its rear panel. You should note this serial number in the space provided below and retain this book, plus your purchase receipt, as a permanent record of your purchase to aid in identification in the event of theft or loss, and for Warranty Service purposes.

Model Number

Serial Number

Panasonic Corporation

Web Site: <http://www.panasonic.com>

English

© Panasonic Corporation 2017

Printed in Malaysia