

5.1.2 CS-YU18ZKA CS-YU24ZKA

<Top View>

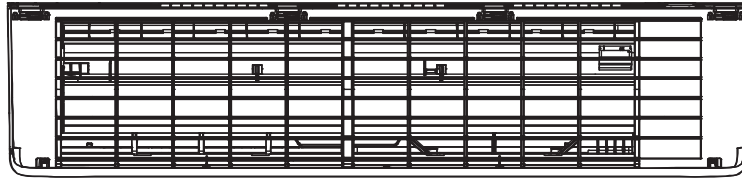

<Side View>

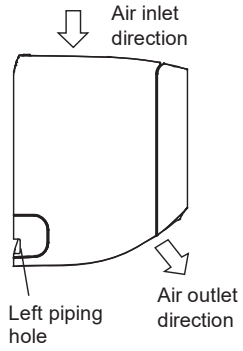

<Front View>

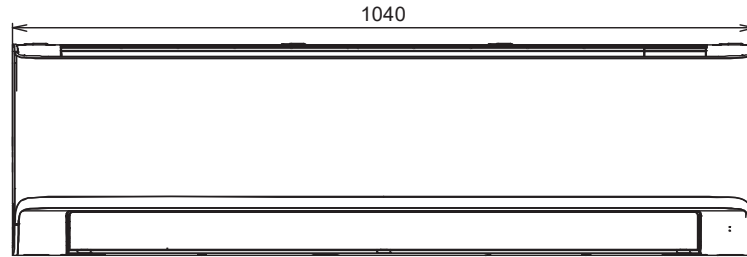

<Side View>

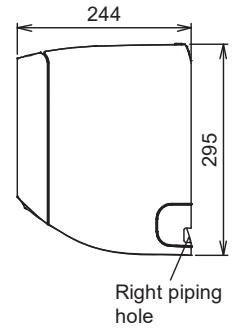

<Bottom View>

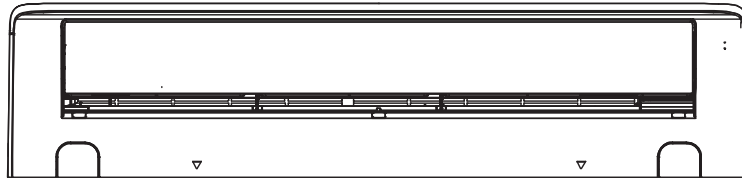

<Remote Control>

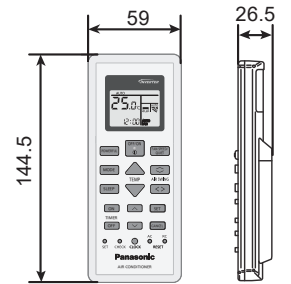

<Rear View>

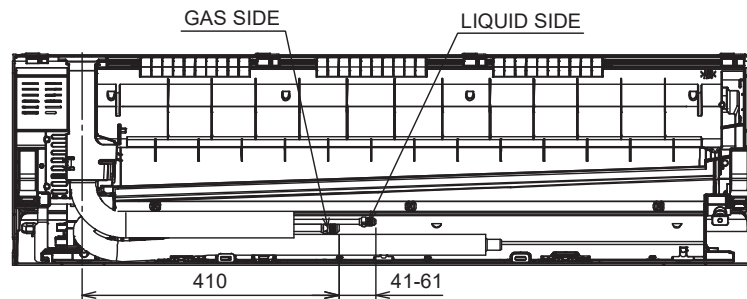

<Remote Control Holder>

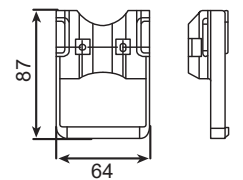

Relative position between the indoor unit and the installation plate <Front View>

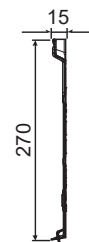
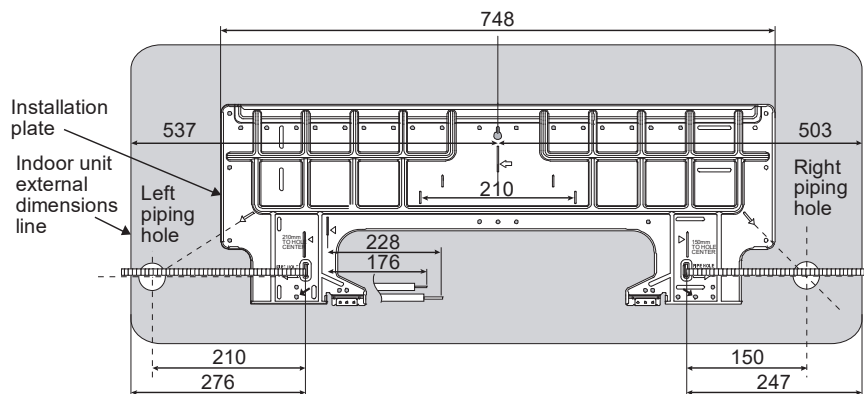

Unit: mm

5.2.3 CU-YU18ZKA

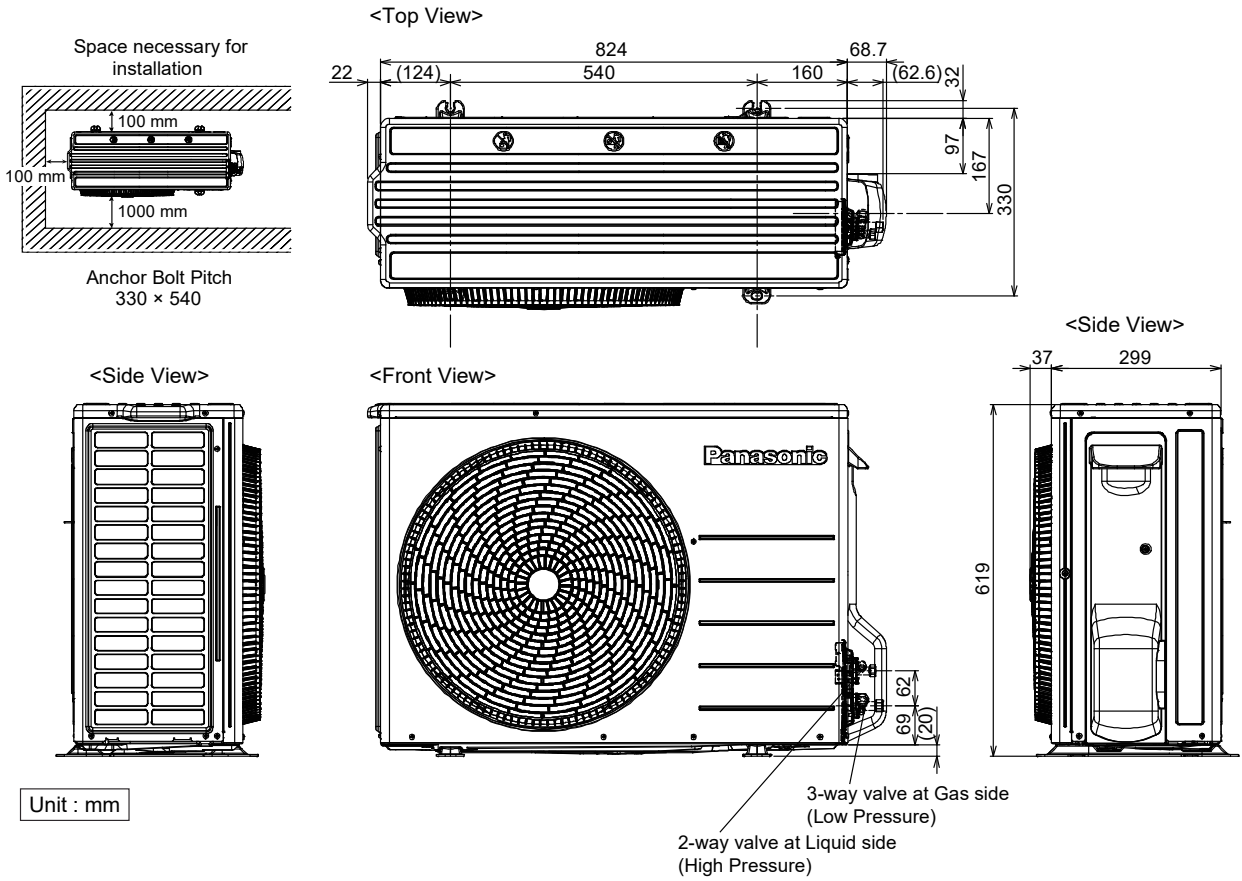

5.2.4 CU-YU24ZKA

