

# Panasonic®

## Operating Instructions 使用說明書

Electric Thermo Pot Household Use

電子保溫熱水瓶 家庭用

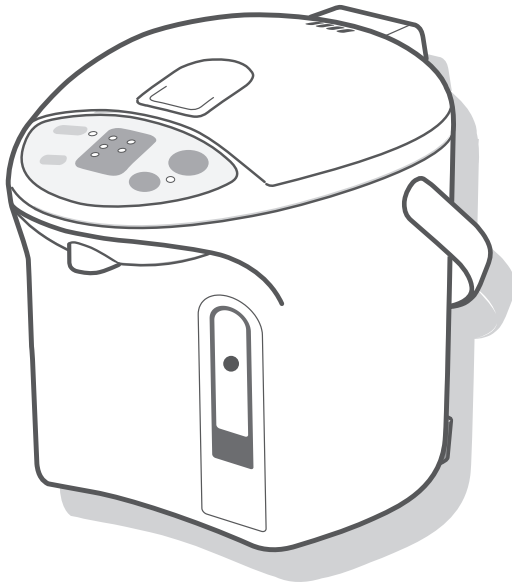

Model No./ 型號 **NC-EG4000**  
**NC-EG3000**  
**NC-EG2200**

Thank you for purchasing this Panasonic product.

- Please read this Operating Instructions carefully in order to use this product correctly and safely.
- Before using this product, **please give your special attention to the Safety Precautions.**
- Please keep this Operating Instructions for future use.
- Panasonic will not accept any liability if the appliance is subject to improper use, or failure to comply with these instructions.

感謝購買本樂聲牌產品。

- 請細閱本操作說明書，以正確及安全地使用本產品。
- 使用本產品前，**請特別注意安全措施。**
- 請保留本操作說明書作日後使用。
- 若不正確使用器具或未有遵照說明書指示，樂聲牌將概不負責。

①

## Table of Contents

Main Features.....	4
Safety Precautions .....	5-7
Part Names and Handling Instructions .....	8-9
How to Use .....	10-11
Convenient use methods.....	12-13
Daily Maintenance .....	14
• How to clean the inner container using citric acid .....	15
Troubleshooting.....	16
Replacement of Parts.....	17
Specifications .....	17

## 目錄

主要特點 .....	18
安全注意事項 .....	19-21
各部分名稱和操作方法 .....	22-23
使用方法 .....	24-25
方便的使用方法 .....	26-27
日常保養方法 .....	28
• 當附著水垢時，請用檸檬酸清洗 .....	29
故障排除 .....	30
更換易耗品 .....	31
規格 .....	31

# Main Features

## Easy to Clean

- **Charcoal coated non-stick inner container**  
The inner container is fluoridated with floury charcoal, which is easy to clean and maintain.

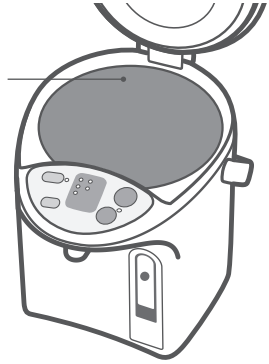

## Convenient

- **Electric dispense**  
(See "Dispensing" on P.10-11)
- **Slow Drip mode for making drip coffee (P.12-13)**

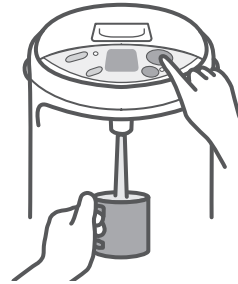

## Economy use

- **6h Timer**  
(See "Setting the 6h timer" on P.12-13)
- **4 Keep-warm temperature selections**  
98 / 90 / 80 / 70 keep-warm temperature can be selected.  
(See "Keep-warm Function" on P.12-13)

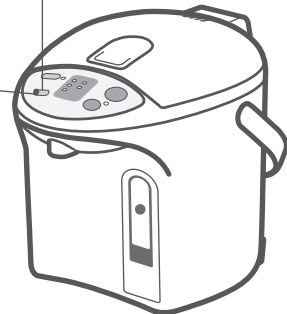

# Safety Precautions

Please take these precautions strictly

For your safety and in order to prevent the property damage and the hazards to the users and others, please read the following instructions strictly.

- The signals indicate harm and damage when the product is used wrongly.



## WARNING

Indicating "it may cause severe injuries and death."



## CAUTION

Indicating "the user may get injured or the product may cause the property damage."

- The symbols indicate specified items that must be followed.



This symbol indicates prohibition.



This symbol indicates mandatory.



# WARNING

## To Prevent Burns



- **Do not let the unit fall over. Do not lift, tilt or shake the unit or carry it by the lid.**  
Even when the Pour Out key is locked, hot water may leak through the dispensing spout and the steam vent, causing burns, if the unit falls over or is tilted.

- **Do not close the lid by force.**  
Hot water can spill causing burns.
- **Do not pour in water above the maximum water level indication line.**  
If the appliance is overfilled, boiling water may be ejected. Hot water can spill causing burns.

- **Do not boil anything other than water.**  
Do not heat tea bags, tea leaves, milk, alcohol or anything other than water which may cause it to spurt out hot liquid or steam and cause burns.  
The water tube may also get clogged, the inner container may burn or corrode, and the fluororesin insulating coating may peel off.

- **Do not block the steam vent.**  
Hot water can overflow causing burns.
- **Do not throw away the remaining hot water while the lid is attached.**  
If the lid comes off, hot water may splash causing burns.

- **Do not touch the steam vent.**  
This may cause burns. Take special care to prevent infants from touching the steam vent.



- **This appliance is not intended for use by persons (including children) with reduced physical, sensory or mental capabilities, or lack of experience and knowledge, unless they have been given supervision or instruction concerning use of the appliance by a person responsible for their safety.**  
**Children should be supervised to ensure that they do not play with the appliance.**

- **Close the lid securely.**

If the unit topples, hot water may spill out causing burns.

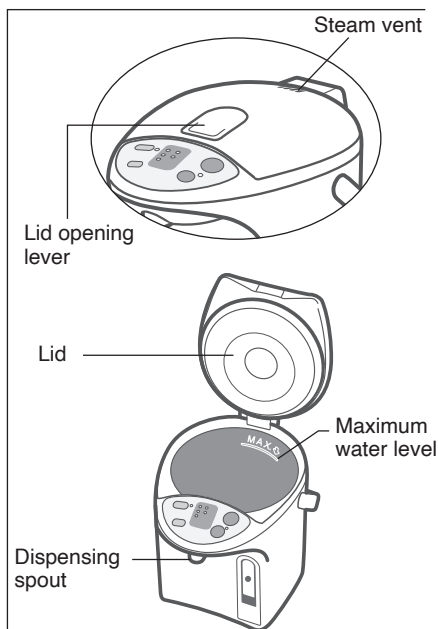

# Safety Precautions

Please take these precautions strictly



## WARNING

### Power Cord



- **Never do anything that might cause damage to the cord, power plug or body plug.**

Do not damage them, modify them, place hot objects near to them, bend them, twist them, stretch them, place heavy objects on them, or bundle them together.

If the unit is used when damaged, electrical short circuit or fire may cause.

- If the supply cord is damaged, it must be replaced by the manufacturer, its service centre or similarly qualified persons in order to avoid a hazard.
- **Do not connect or disconnect the power plug or the body plug with wet hands.**  
This may cause electric shock.
- **Do not allow infants access to the body plug.**  
You must pay special attention to prevent infants from putting the body plug into their mouths. This may cause electric shock or injury.
- **Do not place small metal parts near the body plug.**  
This may cause electric shock, electrical short circuit or fire.
- **Make sure the power plug is correctly inserted into the wall outlet.**  
If the plug is inserted improperly it may cause electric shock or generate heat causing fire.
  - Do not use a damaged plug or a connection in a loose outlet.
- **To prevent electric shock and/or fire, dust off power plug or body plug regularly.**  
Water-laden dust settled on the cable or plug may cause insufficient insulation.
  - Remove the plugs and clean them with a dry cloth.
- **Use a single outlet that matches the power rating of the unit.**  
Plugging multiple appliance into one outlet may generate heat and cause fire.

### Power cord

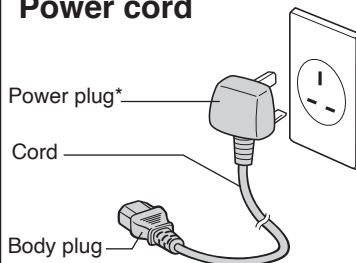

\* The shape of plug differs according to region.



### During use



- **Do not immerse the unit, connector of power plug and body plug in water or splash water over them.**
  - Do not supply water directly from the tap or place the unit in a sink where the bottom may get wet.
  - Do not turn the unit upside down when the bottom is wet.  
This may cause a short circuit and electric shock, due to water enters the electrical parts in the main unit.
- **Never disassemble, repair or modify the unit.**  
Any attempt to do so may cause the unit to operate abnormally and may cause fire or injury.
  - Please contact an authorized dealer for a check or repair.
- **Do not use to store ice.**  
Condensation will occur, creating a potential source of electric shock and malfunction.



# CAUTION

## To Prevent Burns



- **Do not place the unit on unstable surfaces.**  
The appliance may topple over causing burns.
- **Do not open the lid or dispense hot water while boiling.**  
Splashing hot water or steam may cause burns.
- **Do not rotate the unit while dispensing hot water.**  
Splashing hot water may cause burns.
- **Do not touch the hot parts of the unit during use or shortly after use.**  
This may cause burns.



- **When opening or closing the lid, keep hands away from the steam.**  
Steam can cause burns.
- **When carrying the unit, do not touch the lid opening lever.**  
The lid may open causing burns and other injury.
- **The heating element surface is subject to residual heat after use. Wait until the unit is cooled down before maintenance.**  
A hot appliance may cause burns.
  - When disposing hot water, be careful not to get burned.

## Power Cord



- **Do not use a different power cord and do not use this power cord with any other device. (Do not use a power cord other than the one designed specifically for the unit.)**  
It may cause malfunction or fire.



- **When the unit is not in use, unplug the power plug from the wall outlet.**  
Deteriorating insulation may cause electric shock and/or fire.
- **When unplugging the unit, pull by the power plug - not the cord.**  
Electric shock and short circuit may cause fire.

## During use



- **Do not use the unit on surfaces that can be affected by heat for a long time.**  
The unit may get discolored or break up.
- **Do not place near walls or furniture.**  
Steam and heat could damage walls and furniture, causing a change in color and shape.



- **Replace gasket if it discolors whitish. (P.17)**  
Otherwise it may cause hot water to spill out when it is leaned or knocked down accidentally.
- **This product is intended for household use only.**
- **Ensure to clean the surfaces in contact with food after use.**  
(See page 14-15 "Daily maintenance".)

# Part Names and Handling Instructions

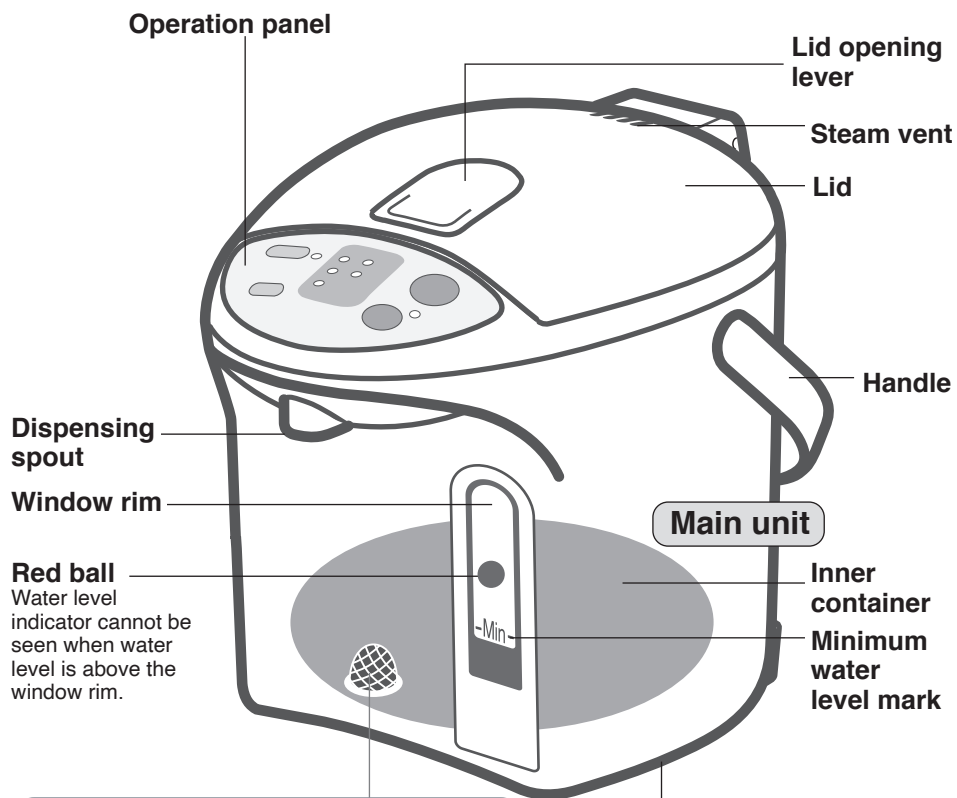

## Mesh filter

### (Replaceable part)

It may have been come off from the bottom of the inner container.

Push it completely into the correct position. (See P.17)

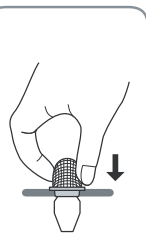
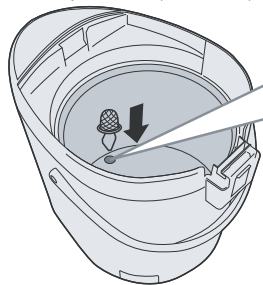

APB97-480-0U

## Rotating base (360 degrees)

When rotating the unit, do not allow the cord to wind around the main unit.

## Power cord

Power plug\*

Cord

Body plug

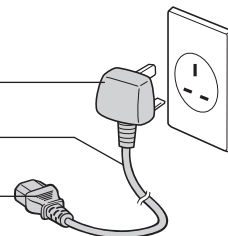

\*The shape of plug differs according to region.



## How to Remove the Lid

**Press and lift the lid opening lever to open the lid.**

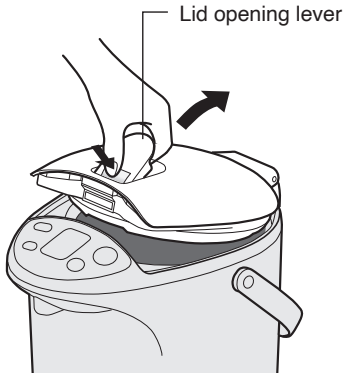

### To close

Press down until hearing "click" sound.

**Pull it up slantwise while pressing the lid release lever.**

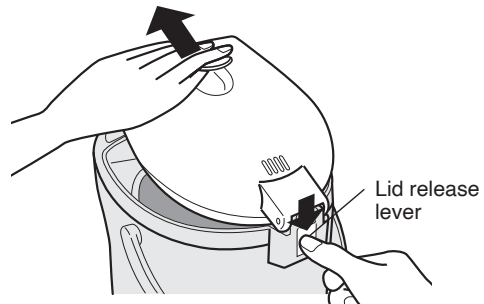

### To attach

Insert the lid slantwise.

## Overheating Protection

If an empty inner container is heated, the overheat safety function (which prevents an empty inner container from being heated) will be activated. The power will be shut off automatically to prevent the problems that may occur due to overheating. This will be shown on the display as shown below.

Flashing alternately

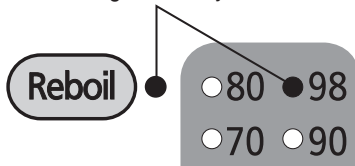

### Causing

- Less than the minimum water level in the inner container was boiled.
- After water is added, the lid might be left open.

### How to cancel the display

Supply water into the container, and press **Reboil** key.

### Notice

If an empty inner container is heated, an odor will be emitted and the container may be discolored.

# How to Use

How to Use

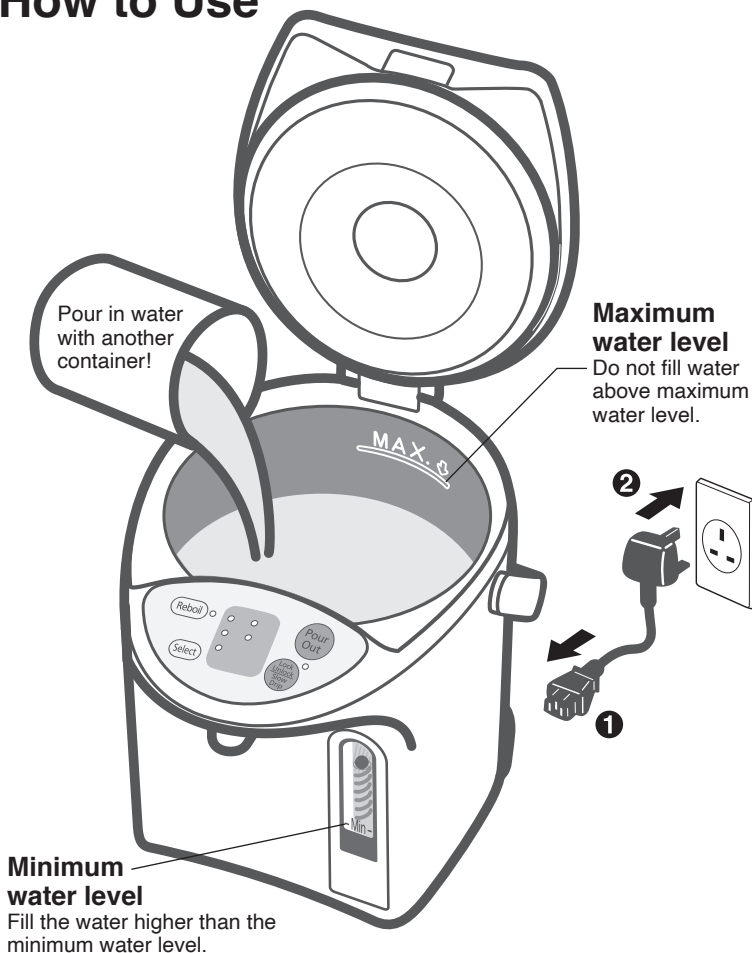

## Before you use this unit for the first time

- 1 Pour in water with another container to the maximum level.
- 2 Close the lid securely.
- 3 Boil the water until Reboil light goes out.
- 4 Dispense the hot water.
- 5 Unplug and remove the lid.
- 6 Pour out any remaining hot water slowly via the DRAIN mark.

## How to reduce the chlorine in the water

Press **Reboil** key to make the indicator light flash. (Long Boil mode)

( Press one time while water is being boiled, )  
( and press twice while water is being kept warm. )

Extends the boiling time by about 6 minutes to reduce the chlorine by about 80% in the water.

- Press **Reboil** key again to boil.

Pour in water with another container. Close the lid securely.  
**Securely plug the body plug horizontally into the body.**  
**Plug into wall outlet. (P.10 ①→②)**

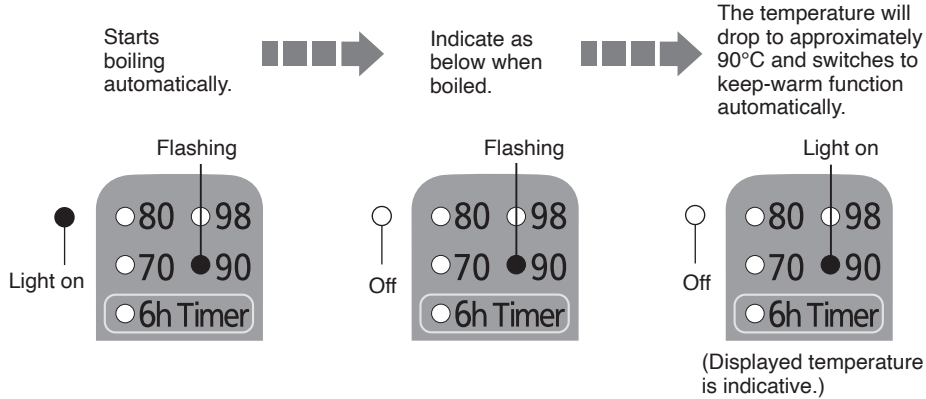

**Time required to boil water**

NC-EG4000: approx. 35 min. / NC-EG3000: approx. 27 min. / NC-EG2200: approx. 20 min.  
 (Amount of water: Maximum Water / Room temperature: 20°C)

Press **Lock/Unlock/Slow Drip** key to release lock. The indicator light beside the key will light up.

Press twice **Lock/Unlock/Slow Drip** key for slow drip. The indicator light beside the key will flash. (See "slow drip" on P.12-13)

Press **Pour Out** key to dispense the hot water.

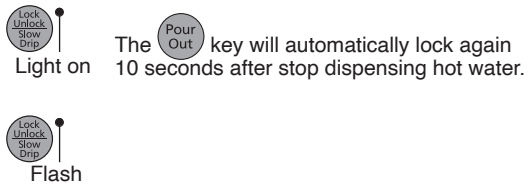

**When the unit is not in use**

Unplug, and remove the lid. Pour out any remaining hot water slowly via the **DRAIN** mark.

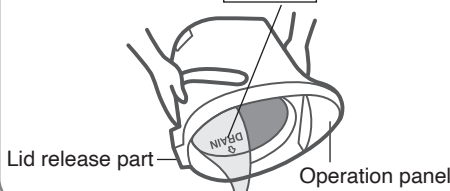

**Cautions**

- Do not pour out water too swiftly. (If water splashes over lid release part or operation panel, it may cause a malfunction.)
- Do not leave water in the inner container. (It may cause the container to corrode or smell.)

# Convenient use methods

Convenient use methods

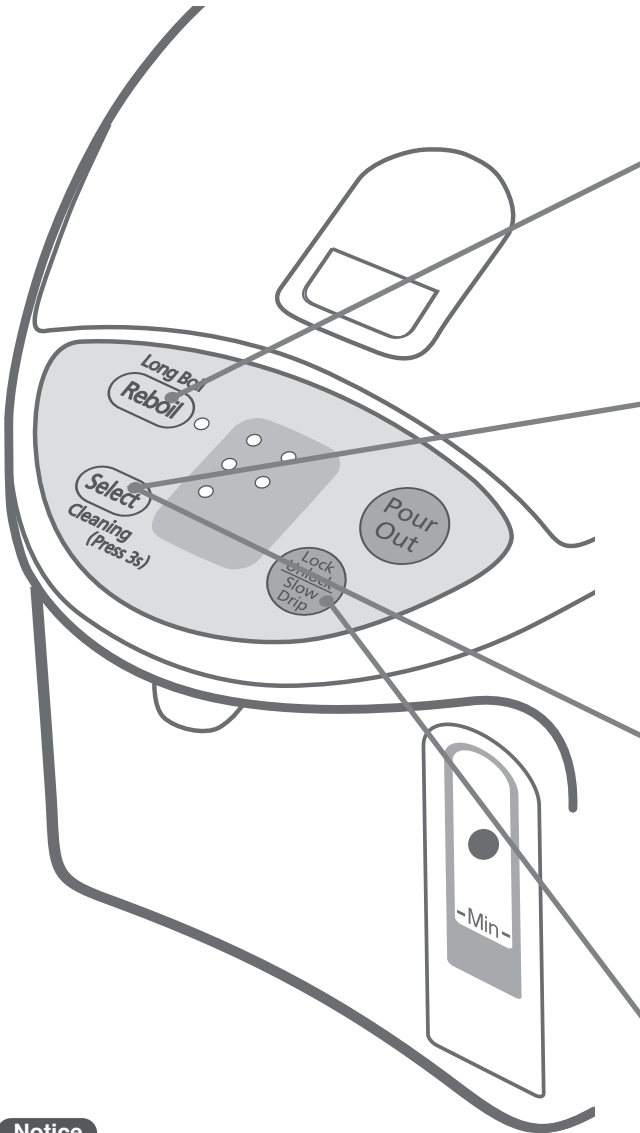

## Reboil

- It is ideal to use boiling water for making coffee / tea / instant cup noodle etc.

## Keep-warm function

- "80 keep-warm" is an ideal mode for making green tea.
- "70 keep-warm" is an ideal mode for making milk for a baby. Be sure to leave milk to cool down or mix it with cool boiled water before giving it to a baby.

- When the unit will not be used for a short time, such as when you go out for a day...

## Setting the 6h timer

- While setting the timer, the electrification of heater stops.

### Notice

- The keep-warm temperature or the timer can be set while the water is being boiled or being kept warm.
- After power is restored in the event of a power failure, the keep-warm temperature will be automatically set to 90, even if the timer or the "98", "80" or "70" keep-warm function was previously selected.

## Slow Drip mode for making drip coffee

- Dispense water slowly.
- Right after boiling, it maybe difficultly dispensed or be dispensed unsteady.

Press **Reboil** key to reboil water that is being kept warm.

After a few minute, water will be boiled.

- The keep-warm temperature setting is left unchanged.

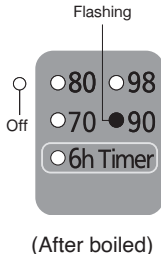

**Time required for the reboil procedure**

From 98 keep-warm: approx. 2.5-4 min.  
 From 90 keep-warm: approx. 4-6.5 min.  
 From 80 keep-warm: approx. 6-12 min.  
 From 70 keep-warm: approx. 7-14 min.

( Amount of water: Maximum )  
 ( Room temperature: 20°C )

Press **Select** key.

○ 80 ○ 98

○ 70 ● 90

○ 6h Timer

Each time the key is pressed, “●” mark will shift to the next choice and change the keep-warm temperature or set the timer.

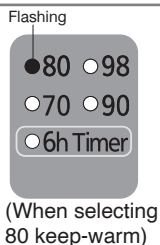

**Time required to reach the settled keep-warm temperature**

90 → 98 keep-warm: approx. 2-4 min.  
 90 → 80 keep-warm: approx. 0.5-1 hour  
 90 → 70 keep-warm: approx. 1.5-2.5 hours

( Amount of water: Maximum )  
 ( Room temperature: 20°C )  
 ( Previous keep-warm setting: 90°C )

After a short time, water will be kept warm at approximately 80°C.

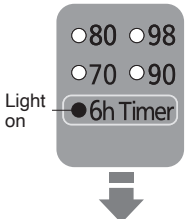

**6 hours later, timer will turn off and water starts boiling**

When the water is brought up to boiling temperature, it will be kept warm at 90°C.

Press **Lock/Unlock/Slow Drip** key twice, then press **Pour Out** key for making drip coffee.

- Automatically locked in 30 seconds after dispensing is finished.
- To dispense hot water again, press **Pour Out** key before time count up to 30 seconds.
- The **Pour Out** key will automatically lock again 10 seconds if **Pour Out** key is not pressed.

Each time **Lock/Unlock/Slow Drip** is pressed, function will be switched as below.

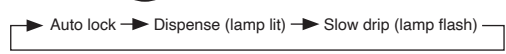

# Daily Maintenance

(Before cleaning, be sure to disconnect the power plug from outlet, dispense water and cool down the unit.)

## Main unit and lid

### Clean with a damp, well-wrung cloth.

- Do not wet or soak the main unit in water.  
(If water enters the main unit from the bottom or from the dispensing spout, it can also get into the electrical components in the main unit and may cause a malfunction.)
- Do not use detergents.  
(They may leave an odor.)
- Do not use benzine or thinner.  
(They may damage the surface.)

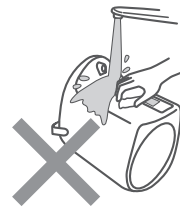

## Inner container

### Clean with a wet soft sponge.

- Do not use polishing powder, a scrub brush or a nylon brush.  
(They may damage the fluororesin finish of the inner container.)

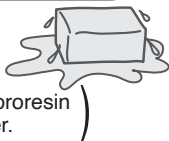

## About "Scale"

While you are using this unit, minerals contained in the water (like calcium) can get stuck on the inner container or on the mesh filter. This is called "scale", and it is harmless.

- Milky-white gritty surface (caused by calcium)
- White or glittering floating material (crystals of minerals)
- Discoloration in the finish like dark brown, gray, or green areas (metallic ion made on the fluororesin covering)

These are not discoloration or corrosion of the inner container itself, nor are they flakes from the fluororesin covering.



**Clean the inner container using citric acid. (See P.15)**

## Mesh filter

### Clean the filter with a brush.

When filter is clogged, water does not flow smoothly.

\* After cleaning the filter, be sure to reattach it to the inner container.

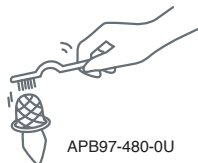

APB97-480-0U

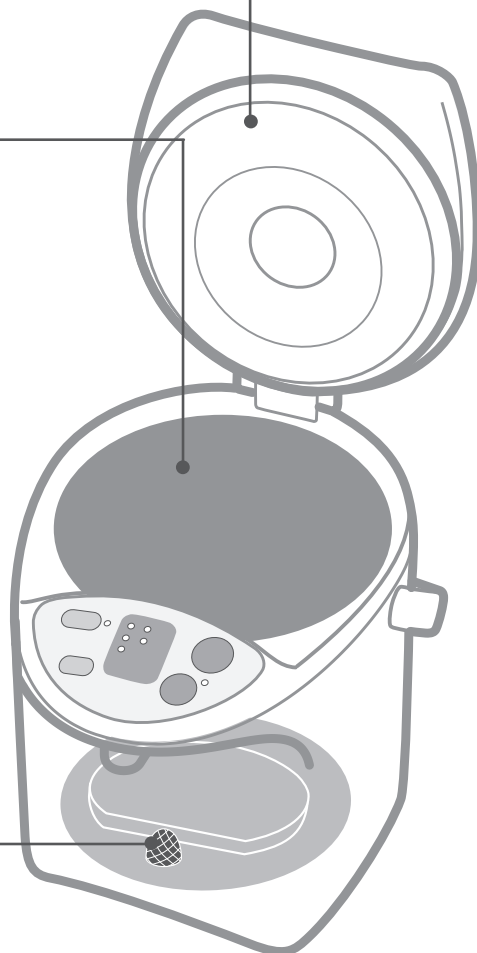

## When storing the unit

- Dry it thoroughly.
- Put it into a plastic bag and seal the bag to keep insects from getting in.

# How to clean the inner container using citric acid.

(Once every two or three months to clear scale.)  
(More frequent cleaning may be required depending on the usage conditions.)

## 1 Make sure that the mesh filter is attached to the inner container.

## 2 Put citric acid in the inner container.

- Amount of citric acid to be used at one time:  
80 g (two packages) or seven level tablespoons
- \* In case that our citric acid is not available, place 1-2 sliced lemons wrapped with a thin cloth into the inner container instead.  
(The detergency of lemon is less effective than using the citric acid.)

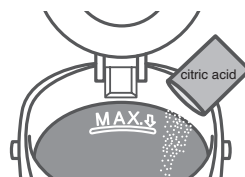

**The citric acid is available from an authorized dealer. (Model No: SAN-80N)**

\* Follow the directions for cleaning printed on the citric acid package.

\* Since the citric acid used for cleaning is a food additive, it is harmless to humans.

## 3 Add water to the maximum water level mark, and mix the citric acid and water well. Close the lid.

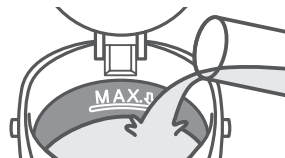

## 4 Connect the plug immediately after stirring and press **Select** key for more than 3 seconds.

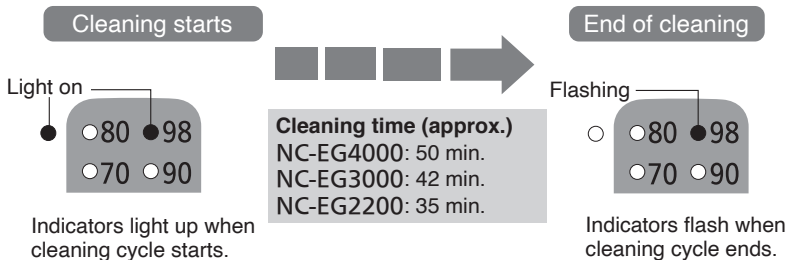

## 5 Dispense some water, then unplug, remove the lid and drain away the hot water via the 'DRAIN' mark.

## 6 Refill with water and boil it to remove the smell of the citric acid or lemons. Then throw the hot water away as same as step 5.

- To remove any discoloration from the area above the maximum water level, rub the inside lightly with a wet soft sponge.
- If the discoloration cannot be removed by rubbing, clean the inner container several times using citric acid or lemons.

### Cautions

- Please use citric acid to clean the inner container of this unit.
- Do not fill with water above maximum water level.
- Fill the inner container only with tap water (do not fill with hot water). Hot water may spout out causing burns.

# Troubleshooting

Before calling a service supplier, please check the following possible causes.

## Troubleshooting

If...	Possible cause	How to fix
White or glittering flakes floating in the hot water. Rough milky white substances are adhered to inner container.	<ul style="list-style-type: none"> <li>The cause of this is "scale". (see P.14) It is not flakes of fluororesin.</li> <li>*Water with a large content of minerals in it such as mineral water or ionized water, is more likely to cause a scale or white layer in the hot water.</li> </ul>	<ul style="list-style-type: none"> <li>Clean the inner container with a wet soft sponge. (See P.14)</li> <li>If the "scale" still remains, clean with citric acid. (See P.15)</li> </ul>
Boiling sounds become louder.	<ul style="list-style-type: none"> <li>When "scale" adheres, boiling sounds become louder.</li> </ul>	
Hot water has odors of chlorine.	<ul style="list-style-type: none"> <li>Odors of chlorine remain depending on the amount of chlorine in tap water.</li> </ul>	<ul style="list-style-type: none"> <li>Press <b>Reboil</b> key to reduce the chlorine. (See P.10)</li> </ul>
Hot water has an unpleasant odor.	<ul style="list-style-type: none"> <li>When the unit is new, resin used in the manufacturing process may give off a mild odor. This will disappear with use.</li> <li>If the unit is placed on surfaces such as a vinyl sheet, the odor may be carried over into the water.</li> </ul>	
Hot water comes out by itself.	<ul style="list-style-type: none"> <li>Water has been added above maximum water level.</li> </ul>	<ul style="list-style-type: none"> <li>Lower the water level.</li> </ul>
Hot water does not flow out smoothly.	<ul style="list-style-type: none"> <li>The mesh filter may be clogged with "scale". (See P.14)</li> <li>When scale is accumulated in the inner container and remaining hot water is low, hot water does not flow out smoothly.</li> <li>Immediately after boiling, hot water may not flow out smoothly.</li> </ul>	<ul style="list-style-type: none"> <li>Clean the filter with a brush.</li> <li>If the "scale" cannot be removed, replace the filter (See P.17)</li> </ul>
The indicator lights flash alternately.	<ul style="list-style-type: none"> <li>Overheating protection has been activated (See P.9)</li> </ul>	<ul style="list-style-type: none"> <li>Add water and press <b>Reboil</b> key.</li> </ul>
	<ul style="list-style-type: none"> <li>The indicator lights may flash alternately by adding boiling water or the way the water is supplied.</li> </ul>	<ul style="list-style-type: none"> <li>Press <b>Reboil</b> key.</li> </ul>
	<ul style="list-style-type: none"> <li>When the inner container is cleaned with citric acid, citric acid has built up on the bottom.</li> </ul>	<ul style="list-style-type: none"> <li>Disconnect the plug, and stir the citric well to dispose.</li> </ul>
Hot water does not dispense.	<ul style="list-style-type: none"> <li>The automatic lock has been engaged.</li> </ul>	<ul style="list-style-type: none"> <li>Press <b>Lock Unlock Slow Drip</b> key.</li> </ul>
<ul style="list-style-type: none"> <li>If the problem is not fixed after checking the above possible causes, or if you think something is strange, disconnect the body plug from the unit. Wait at least 10 seconds and then re-connect the plug.</li> <li>The semi-transparent inner part inside the lid may become yellowish. This does not affect operation of the unit.</li> <li>The rattling noise in the lid is made by small ball-shaped components which prevent water from flooding out if the unit topples over.</li> <li>If the room temperature is very high, the outside of the main unit may reach about 55°C.</li> </ul>		
The unit does not turn on.	<ul style="list-style-type: none"> <li>You poured in water directly from a tap.</li> </ul>	<ul style="list-style-type: none"> <li>It is broken if the electric components are immersed in water. Contact the store where you purchased the unit for repair.</li> </ul>
	<ul style="list-style-type: none"> <li>You put the unit on the sink.</li> </ul>	
	<ul style="list-style-type: none"> <li>You turn the unit upside down with its bottom wet.</li> </ul>	
	<ul style="list-style-type: none"> <li>You washed the unit in water.</li> </ul>	
"Reboil" and "80" indicator lights flash alternately.	<ul style="list-style-type: none"> <li>This is malfunction of the sensor.</li> <li>Contact the stores where you purchased.</li> </ul>	



# Replacement of Parts

## Rubber gasket set

Replace gaskets if they crack, lose their pliability or, for any other reasons which allow steam to escape from between the container and the lid.

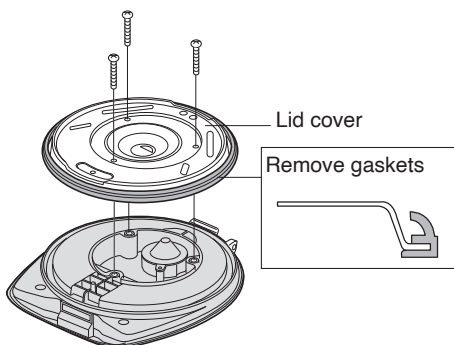

Remove lid, unscrew 3 tapping screws and remove the lid cover.

Exchange the gaskets and then place the lid cover back and secure with the tapping screws.

## Mesh filter

Replace the filter, if foreign matter which clog the filter cannot be removed, even after you scrub with a cleaning brush, etc.

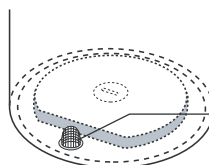

The filter can be removed by pulling firmly on it.

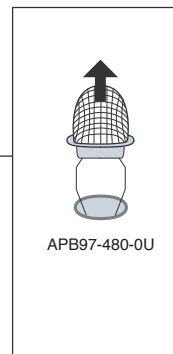

**For replacement parts, please contact an authorized dealer.**

Part name	Part No.
Rubber gasket set	APH65-480
Mesh filter	APB97-480-0U

# Specifications

Model No.		NC-EG4000	NC-EG3000	NC-EG2200
Power supply		220V ~ 50Hz		
Power consumption		700 W		
Average power consumption in keeping warm (approx.) (Amount of water: maximum Room temperature: 20°C)	at 98	49 Wh	45 Wh	40 Wh
	at 90	43 Wh	39 Wh	33 Wh
	at 80	35 Wh	31 Wh	27 Wh
	at 70	30 Wh	26 Wh	23 Wh
Dimensions (when the handle is tilted)	Height (approx.)	32.4 cm	27.5 cm	23.8 cm
	Width (approx.)	21.7 cm	21.7 cm	21.7 cm
	Depth (approx.)	28.7 cm	28.7 cm	28.7 cm
Weight (including power cord) (approx.)		2.2 kg	2.1 kg	2.0 kg
Rated capacity (approx.)		4.0 L	3.0 L	2.2 L

\* Under certain conditions, such as at very high altitudes and in intense cold, the unit may not function properly. Please avoid using the unit in such conditions.

\* If the unit is not used during cold conditions, make sure to empty it of water. The water left in the inner container may freeze causing damage.

# 主要特點

## 輕鬆清潔

- **木炭塗層不粘內膽**  
因內瓶採用粉狀備長碳與氟素混合加工，  
易於清潔和保養。

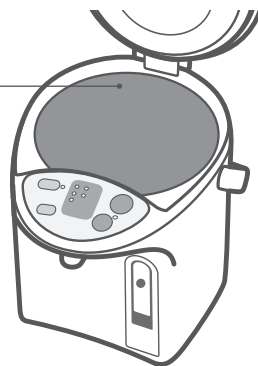

## 方便

- **電動出水**  
(參看第24-25頁的“出水”)
- **慢漏模式製作滴漏咖啡** (第26-27頁)

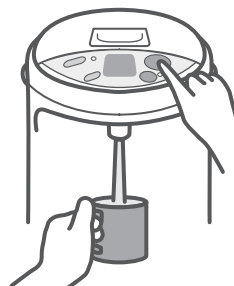

## 使用經濟

- **6小時定時器**  
(參看第26-27頁的“設定6小時定時器”)
- **4種保溫溫度選擇**  
可以選擇約98/90/80/70度保溫功能。  
(參看第26-27頁的“保溫功能”)

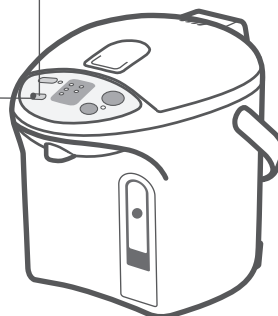

# 安全注意事項

務必遵守

為了您的安全和有效地防止損傷、避免對其他人造成危險，請認真閱讀以下說明。

■ 下面標記表示當不正確使用該產品時將出現傷害與損壞。



## 警告

這一標示欄表示“可能會導致死亡或重傷等”的內容。



## 注意

這一標示欄表示“可能會導致傷害或僅發生物質損害”的內容。

■ 下面符號表示務必遵守的詳細事項。



這個符號表示必須禁止的事項。



這個符號表示強制命令。



## 警告

### 為防止燙傷



● **勿讓本體翻倒。勿提著上蓋、傾斜及搖晃本體或搬動本體**  
即使Pour Out（倒水）鍵已上鎖，熱水瓶若翻倒或傾斜，熱水也會從出水口和蒸汽口流出，導致燙傷。

● **不要用力關閉上蓋**  
否則，熱水溢出，可致燙傷。

● **倒入水時不要超過滿水標記 如果該器具加水過多，可能會噴出沸水**  
否則，熱水溢出，可致燙傷。

● **只能用來燒水**  
若用來煮沸茶袋、茶葉、牛奶、酒，起泡噴出，可致燙傷。而且，會引致水管堵塞、燒焦或腐蝕、內瓶、氟素樹脂脫落。

● **不要用抹布等覆蓋蒸汽口**  
否則，熱水溢出，可致燙傷。

● **倒掉剩水時要卸下上蓋**  
否則，上蓋脫落，熱水濺出，可致燙傷。

● **不要用手觸摸蒸汽口**  
否則，可致燙傷。  
尤其是注意不要讓乳幼兒觸摸



● **本裝置不適合有殘障、智障或精神障礙的人士、缺乏經驗及常識者(包括兒童)使用，除非負責其安全的人士在場監督或指導。應監督兒童，勿讓他們將產品當作玩具。**

● **確切關好上蓋**  
否則，萬一翻倒時，熱水流出，可致燙傷。

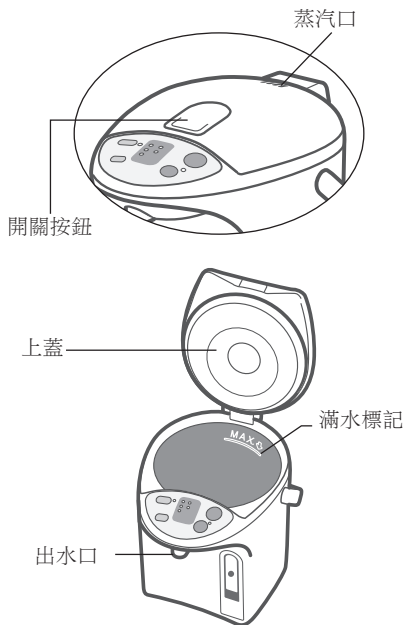

# 安全注意事項

務必遵守



## 警告

### 電源線



- **不要損傷電線、電源插頭、主機插頭**  
不得劃傷、不得加工、不得靠近發熱器具、不得強行彎曲、不得扭擰、不得牽拉、不得壓放重物、不得打捆。  
使用損傷的電線和插頭，可致觸電、短路、火災。
  - 若主電源線損壞，必須由原廠、其服務中心或類似的合資格人士更換，以免產生危險。
- **不要用濕手操作電源插頭和主機插頭**  
否則，可致觸電。
- **不要舔主機插頭**  
注意不要讓兒童舔主機插頭。  
否則，可致觸電和受傷。
- **不要在主機插頭附近放置小金屬物品。**  
否則，可致觸電、短路、着火及火災。



- **確徹插入電源插頭**  
未完全插入時，可致觸電、發熱而引起火災。
  - 不要使用損傷的插頭和鬆動的插座。
- **防止觸電和/或起火，對電源插頭或插體進行定期除塵。**  
落在電線或插頭上的含水灰塵可能會導致絕緣失效。
  - 拔下插頭，用乾布擦拭。
- **單獨使用符合額定電源的電源插座**  
若與其它電器產品共用，可致發熱，發生火災。

### 〔電源軟線〕

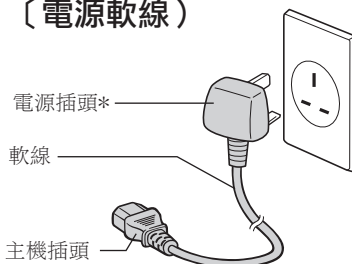

\*插頭的形狀是根據不同地區而不同。

### 操作



- **請勿將本熱水瓶、電源插頭及熱水瓶插頭的連接件浸入水中，或讓水濺到這些部件上。**
  - 請勿用水龍頭直接供水，或將本機置於水槽之中，否則底部可能會弄濕。
  - 當底部變濕時，請勿將本體倒置。  
可能會導致短路和觸電，而且，若水溢出熱水瓶，可能進入本體內置的電子部件中，從而導致功能失常。
- **千萬不要拆卸、修理和改造**  
否則，可致發火或動作異常而傷人。
  - 請聯絡授權代理商心瞭解檢修事宜。
- **不要放入冰塊用作保冷**  
否則，可致結露而引起觸電或故障。

# 注意

## 為防止燙傷



- **不要放在不穩定的地方或軟弱的墊子上**  
否則，熱水瓶翻倒，可致燙傷。
- **煮沸中不要打開上蓋或倒熱水**  
否則，熱水飛濺和蒸氣噴出，可致燙傷。
- **倒水時，不要轉動本體**  
否則，熱水飛濺，可致燙傷。
- **使用中或剛用過後，不要觸摸本體等高溫部分**  
否則，可致燙傷。



- **打開或關閉蓋子時，注意手要避開蒸氣口**  
否則，可致燙傷。
- **搬動本體時，不要觸摸開蓋按鈕**  
否則，上蓋突然開啟，可致燙傷和受傷。
- **使用後加熱元件表面會殘留熱量。等到本產品冷卻後才可觸摸或進行清潔。**  
發熱的產品可能導致灼傷。  
→當廢棄熱水時，請注意不要被燙傷。

## 電源線



- **不要使用非專用電源插頭，也不要將電源插頭用於其他裝置。**  
(請勿使用非本體專用電源線。)  
否則，可致故障、着火及火災。



- **不使用時，從電源插座上拔下電源插頭**  
否則，因絕緣老化可致觸電、漏電，引起火災。
- **拔下電源插頭時，務必握住電源插頭部分，不要牽拉電線**  
否則，可致觸電、短路，引起火災。

## 操作



- **熱水瓶不能長時間在受熱的面上使用**  
否則，將會變色或破損。
- **不要靠近牆壁和家具**  
否則，蒸氣和熱量可損傷牆壁和家具，引起變色或變形。



- **若墊圈變色發白，請更換墊圈。(第31頁)**  
否則熱水瓶傾斜或意外翻倒時熱水會溢出。
- **本產品僅供家居使用。**
- **確保使用後清潔接觸食物的表面。**  
(見第 28 至 29 頁 “日常保養方法” .)

# 各部分名稱和操作方法

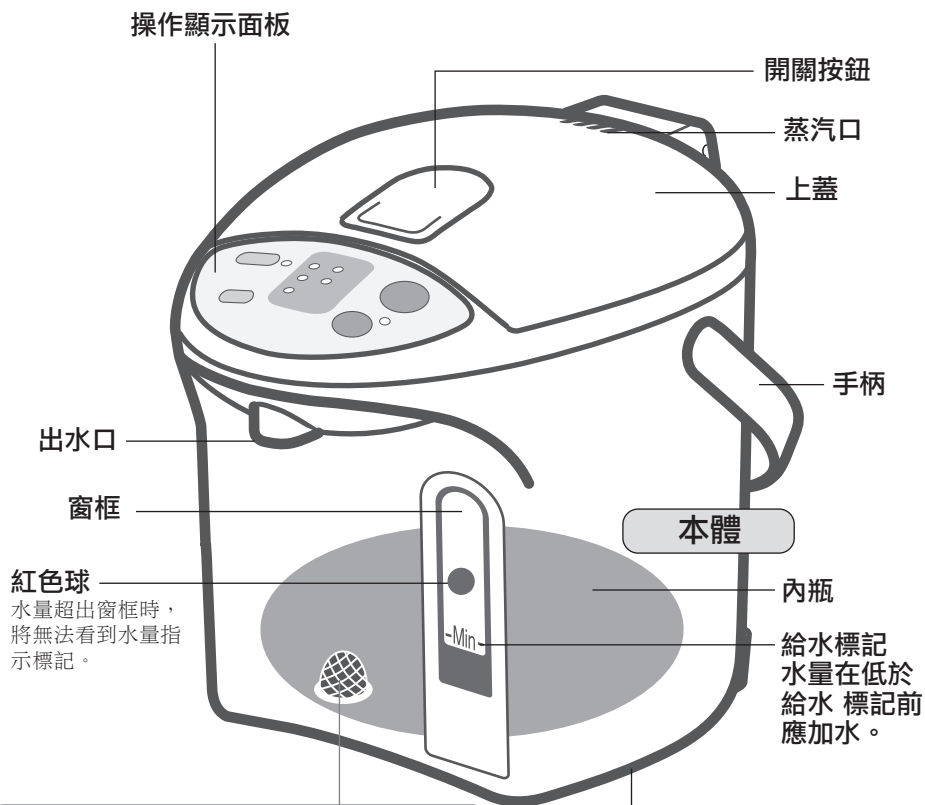

## 過濾網

### (易耗品)

過濾網有可能從內瓶底部脫落。脫落時，應將它完全裝入正確位置上。(參看第31頁)

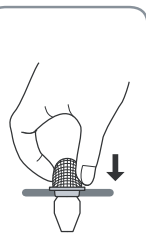
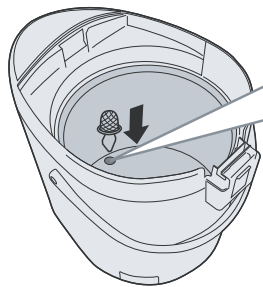

APB97-480-0U

## 旋轉台 (360°)

轉動裝置時，注意不要讓電線纏繞主機。

## 電源軟線

電源插頭\*

軟線

主機插頭

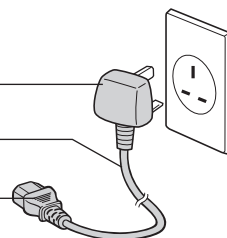

\* 插頭的形狀是根據不同地區而不同。

## 上蓋拆卸方法

按下並提起開蓋手柄，  
打開上蓋。

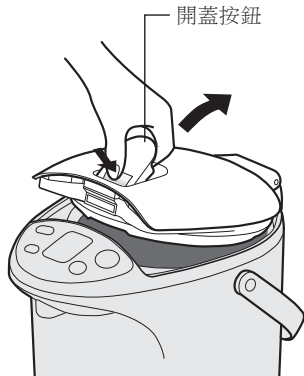

### 關閉時

下按上蓋，直至其咯嗒一聲到位

在按下上蓋裝卸鈕的同時，  
握著開蓋按鈕向斜上方拔出。

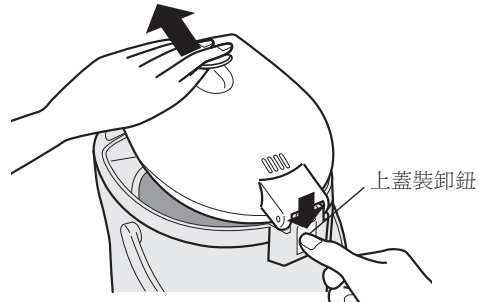

### 安裝時

以一定的角度，插入上蓋。

## 關於防止空燒

在熱水瓶裡已無水時加熱，過熱安全功能（防止內瓶空瓶加熱）會啟動。空燒或水置低於給水標記時煮沸會產生異味，氟棄樹脂變色。

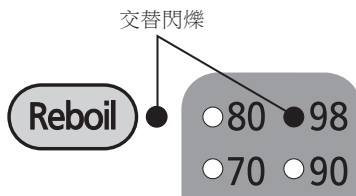

### 原因

- 在內瓶中的水低於最低水位時燒水。
- 加水後，蓋子仍打開著。

### 顯示的取消方法

在內瓶中加水，然後按 **Reboil** 鍵。

### 注意

內瓶空瓶加熱時會產生異味，容器或會變色。

# 使用方法

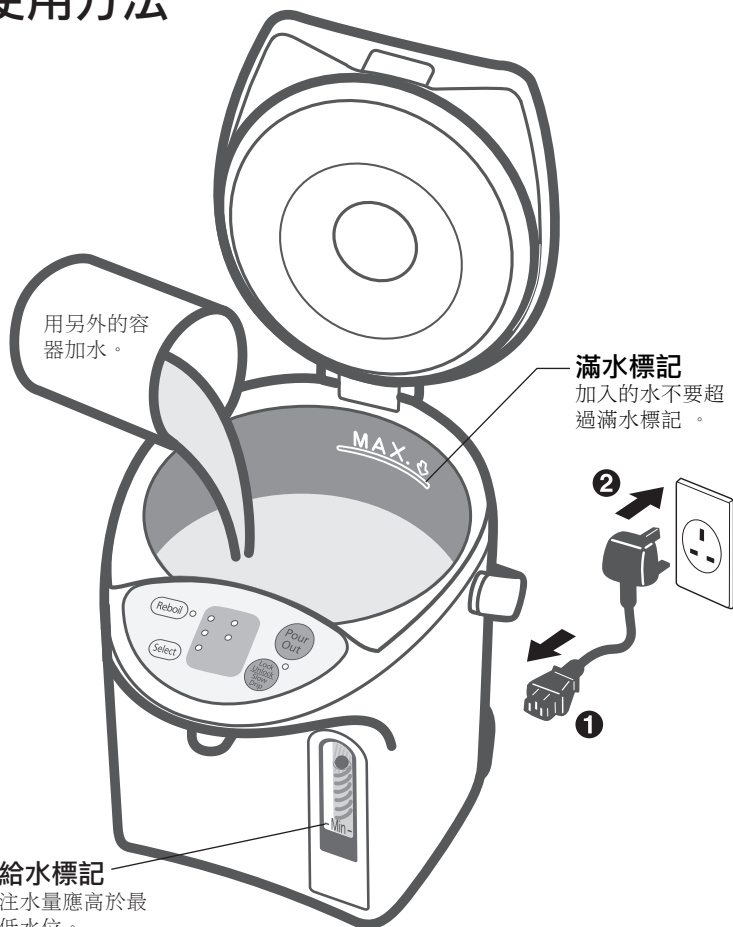

燒水

出水  
(電動出水)

## 第一次使用前

- 1 用另外的容器加水至滿水標記。
- 2 將上蓋蓋緊。
- 3 將水煮沸，直到Reboil（再次煮沸）指示燈熄滅。
- 4 倒掉一些水。
- 5 拔掉電源插頭，取下蓋子。
- 6 對照排水標記，緩慢倒出剩餘的熱水。

## 要減少氯味時

按下 **Reboil** 鍵，指示燈閃爍。  
(長時間沸騰模式)  
(在水煮沸中，按1次，在水保溫中，按2次。)  
延長沸騰時間約6分鐘，  
可減少水中約80%的氯味。

- 要返回煮沸時，再按一次 **Reboil** 鍵。



用另外的容器加水。將上蓋關緊。

將主機插頭水平地插入本體上。  
插入牆壁插座。(參看第24頁①→②)

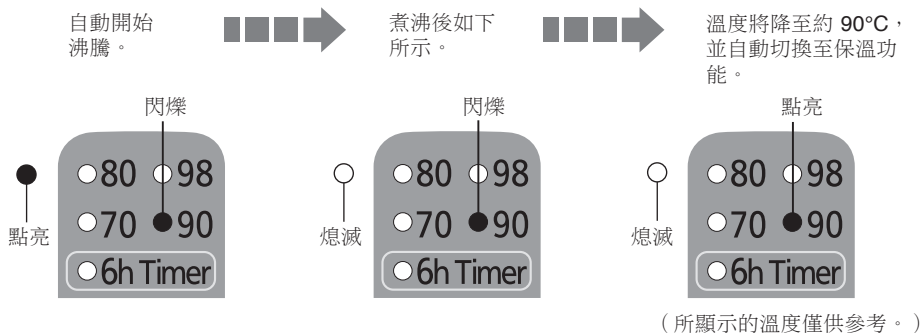

### 水燒開的時間

NC-EG4000:約 35 分 / NC-EG3000:約 27 分 / NC-EG2200:約 20 分  
(水量:最大、水/室溫:20°C)

按 **Lock/Unlock/Slow Drip** 鍵，可解鎖定。  
鍵旁邊的指示燈將會亮起。



按 **Pour Out** 鍵，可熱水流。

按2次 **Lock/Unlock/Slow Drip** 鍵，開始緩慢滴濾式出水。  
鍵旁邊的指示燈閃爍。  
(見第26-27頁「緩慢滴濾式出水」)



在熱水出來後，約10秒鐘，**Pour Out** 將自動重新鎖定。

### 不使用时

取下蓋子。通過 **DRAIN** (排水) 標記，慢慢倒掉所有剩餘的熱水。

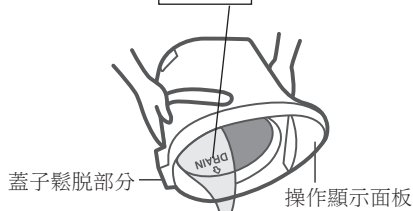

#### 注意

- 請勿倉促倒水。  
(如果水濺到蓋子鬆脫部分和操作面板上，可能會導致功能失常。)
- 請勿讓水留在內瓶中。  
(否則，可能會導致內瓶腐蝕或產生異味。)

# 方便的使用方法

方便的使用方法

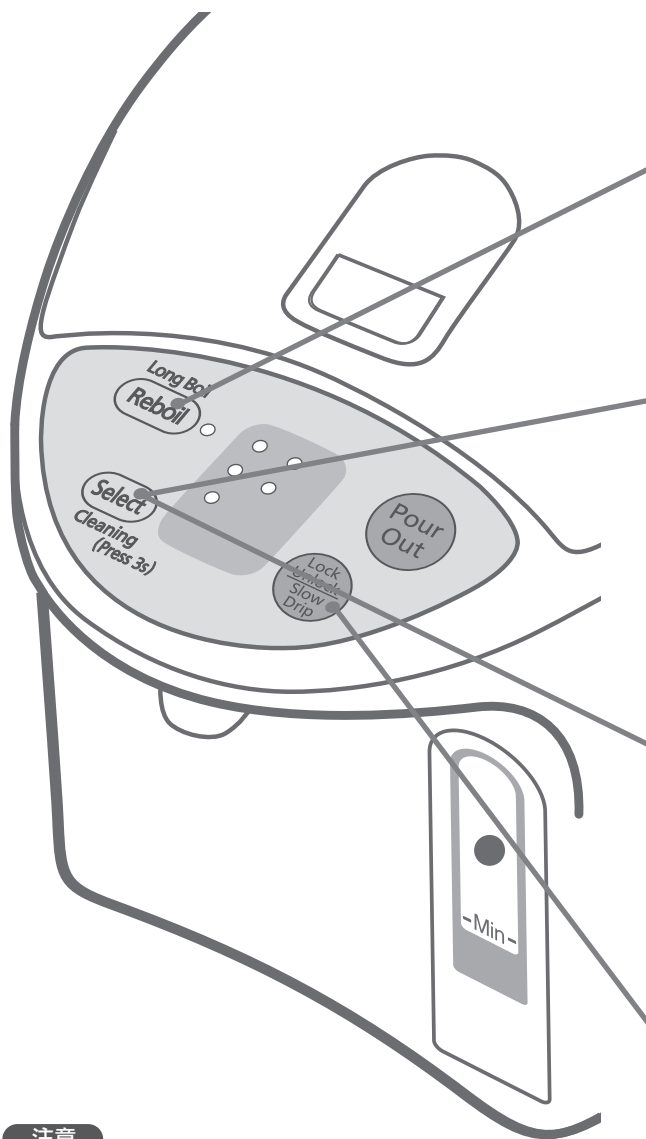

## 注意

- 在水沸騰或保溫期間，可以設定保溫溫度或定時器。
- 在發生電源故障而又恢復供電後，即使以前選擇了定時器或“98”、“80”或“70”保溫功能，保溫溫度仍將會自動設定在90。

## 再沸騰

- 沖咖啡/泡茶/泡方便面等，最好使用沸騰水。

## 保溫功能

- “80°C 保溫”為製作綠茶的理想模式。
- “70°C 保溫”為嬰兒煲奶的理想模式。請將奶在給嬰兒飲用前先冷卻，或與冷開水混和至適當溫度。

出門等暫時不使用熱水瓶時...

## 設定6小時定時器

- 在定時器設定的時間內，加熱器自動斷電。

## 慢漏模式製作滴漏咖啡

- 慢速倒水。
- 水沸騰後可能很難倒出，或倒出時不順暢。

按下 **Reboil** 鍵  將正在保溫的水重新煮沸。  
幾分鐘後，水將沸騰。  
• 保溫溫度和節約定時器的設定無變化。

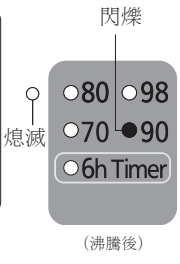

**重新煮沸的時間**  
 從98保溫: 約2.5-4分鐘  
 從90保溫: 約4-6.5分鐘  
 從80保溫: 約6-12分鐘  
 從70保溫: 約7-14分鐘  
 (水量: 最大) (室溫: 20°C)

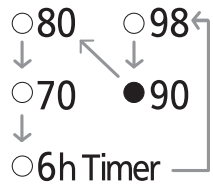
按下 **Select** 鍵 。  
  
 每次按鍵，“●”標記將移到下一個選擇，並改變保溫溫度或設定定時器。

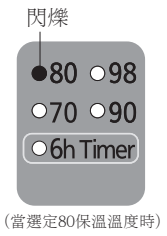

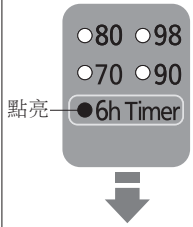

**降至所設定的保溫溫度時所需的時間**  
 90 → 98 保溫: 約2-4分鐘  
 90 → 80 保溫: 約0.5-1小時  
 90 → 70 保溫: 約1.5-2.5小時  
 (水量: 最大、室溫: 20°C) (以前的保溫設定值90°C)

短時間後，水溫將保持在80°C。



6小時後，定時器將關閉，並開始煮沸。  
當水到達沸騰溫度時，將在90°C進行保溫。

按2次 **Lock/Unlock/Slow Drip** 鍵 ，再按 **Pour Out** 鍵  製作滴漏咖啡。

- 當分配操作結束後，將自動鎖定30秒。
- 再次倒出熱水，在30秒內按 **Pour Out** 鍵 .
- 如果沒有按下 **Pour Out** 鍵 ，**Pour Out** 鍵  會在10秒後自動重新鎖定。

每次按下 **Lock/Unlock/Slow Drip** 鍵 ，將會切換至以下功能。



# 日常保養方法

(清潔之前，必須從插座上拔掉插頭，倒掉內瓶裡的水，並讓本機冷卻。)

## 本體、上蓋

### 用擰乾的濕抹布擦拭。

- 不要用水沖洗。  
(否則，水從底部和出水口進入內部，浸濕本體內的電子器件，可致故障。)
- 不要使用洗劑。  
(否則，可留有異味。)
- 不要使用汽油、天拿水等溶解液。  
(否則，可損傷表面。)

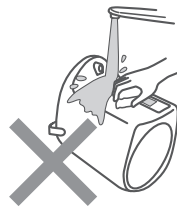

## 內瓶

### 用柔軟的海綿擦拭。

- 不要使用去污粉、草刷、尼龍刷。  
(否則，可損傷氟素樹脂塗層。)



## 關於“水垢”

使用過程中，水中含有鈣質等礦物成分會附在內瓶和過濾網上。這稱為“水垢”，對人體無害。

- 乳白色顆粒狀 (由鈣質引起)
- 白色或閃光的浮遊物 (礦物結晶)
- 茶色、灰色、綠色等變色 (氟素樹脂塗層上形成的金屬離子)

這些既不是內瓶本身的變色或腐蝕，也不是氟素樹脂塗層的剝落所致。



請用檸檬酸清洗內瓶。(參看第29頁)

## 過濾網

### 用刷子等清洗。

當過濾網堵塞時，水流可能會不暢順。  
\*清洗後，務必重新裝在內瓶中。

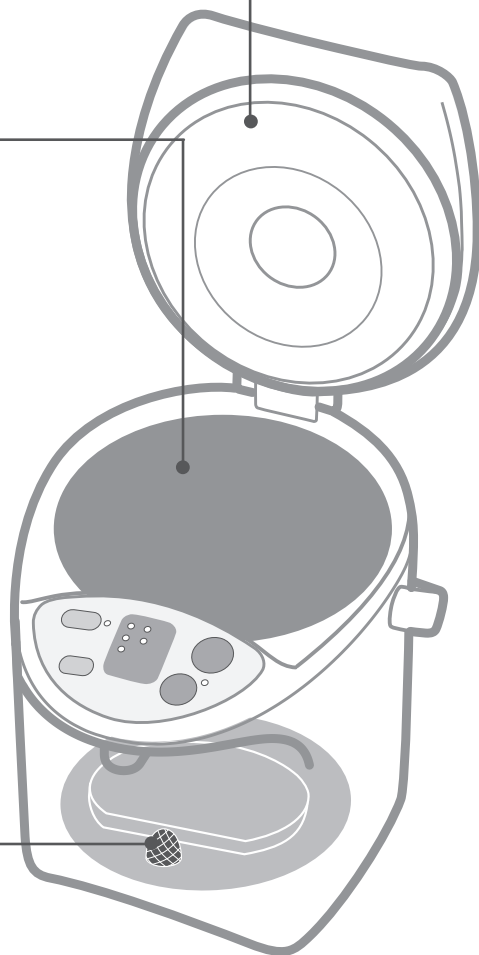
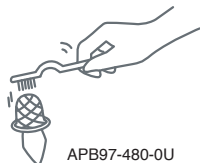

## 保管本機時

- 將其充分乾燥。
- 將其放入塑料袋中密封，防止蟲子鑽入。

# 當附著水垢時，請用檸檬酸清洗

(積垢須每兩、三個月清理一次。  
視乎使用情況，產品可能需要更頻繁清潔。)

**1** 確保濾網裝好在內膽上。

**2** 將檸檬酸放入內瓶內。

- 檸檬酸清洗一次用量  
80克(2袋) 或大茶匙7平匙
- \* 在無檸檬酸可用的情況下，請使用 1 塊薄布包裹 1 到 2 片檸檬薄片放入內瓶中。(檸檬的去垢力沒有檸檬酸好。)

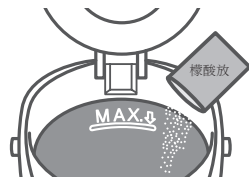

請在經銷店購買清洗用檸檬酸。(型號：SAN-80N)

- \* 請遵守清洗用檸檬酸附屬的說明書注意事項。
- \* 清洗用檸檬酸屬於食品添加物，無礙食品衛生，對人體無害。

**3** 加水至最滿水標記，將檸檬酸與水充分混合。  
關上上蓋。

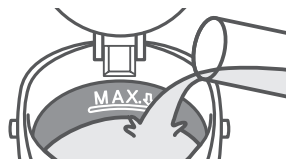

**4** 攪拌後，立即接上插頭，然後按住鍵 **Select** 3秒鐘以上。

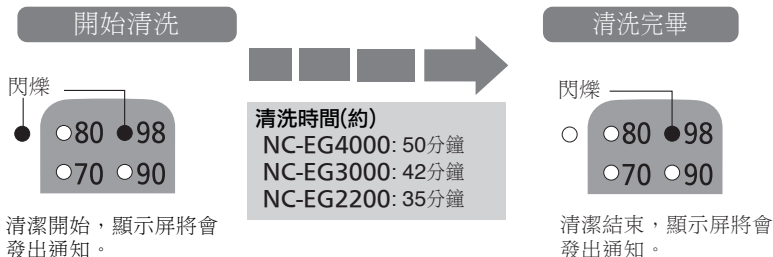

**5** 按 鍵，流出一些水，然後，拔掉插頭，拆下蓋子，通過 'DRAIN(排水)' 標記，倒掉熱水。

**6** 重新裝滿水，將其煮沸，清除檸檬酸或檸檬的氣味。  
然後，與步驟**5**一樣，倒掉熱水。

- 如需去除滿水標記以上的變色，可用濕潤的柔軟海綿輕輕擦拭。
- 如變色嚴重，一次不能清除時，可反復用檸檬酸或檸檬清洗內瓶。

## 注意

- 只能使用本公司生產的熱水瓶清洗用檸檬酸。
- 加入的水不要超過滿水標記。
- 從冷水開始煮沸(不要加入熱水)。否則，熱水起泡噴出，可致燙傷。

# 故障排除

以下所示並非故障。請在洽詢和委託修理之前，自行檢查。

癥狀	原因	處置
熱水中有白色浮游物。粗糙的乳白色物質附著於內瓶。	<ul style="list-style-type: none"> <li>這是脫落的水垢(參看第28頁)，不是脫落的氟素樹脂。</li> <li>* 礦物質多的水(礦泉水、離子淨水器處理的水)易於產生水垢，附在內瓶上或浮在水中。</li> </ul>	<ul style="list-style-type: none"> <li>請用濕潤的柔軟海綿清潔內瓶。(參看第28頁)</li> <li>如果仍有“水垢”，殘留，請用檸檬酸進行清洗。(參看第29頁)</li> </ul>
煮沸的聲音變得更大。	<ul style="list-style-type: none"> <li>當附著“水垢”時，煮沸聲音將變得更大。</li> </ul>	
熱水有氯的氣味。	<ul style="list-style-type: none"> <li>自來水中含有較多消毒用氯，可產生氯味。</li> </ul>	<ul style="list-style-type: none"> <li>按下 <b>Reboil</b> 鍵，以減少氯。(參看第24頁)</li> </ul>
熱水有令人討厭的異味。	<ul style="list-style-type: none"> <li>剛開始使用時，會產生樹脂的異味，隨著使用，將會消失。</li> <li>像放在墊子(塑料單等)上使用，有時墊子味會傳入熱水中。</li> </ul>	
熱水自然流出。	<ul style="list-style-type: none"> <li>加水是否超過滿水標記。</li> </ul>	<ul style="list-style-type: none"> <li>減少水量。</li> </ul>
熱水出水不順暢。	<ul style="list-style-type: none"> <li>過濾網可能被異物堵住，如「水垢」。(參看第28頁)</li> <li>當水垢在內瓶積聚且剩餘的熱水量較低時，熱水無法順暢地流出。</li> <li>煮沸後，熱水無法立即順暢地流出。</li> </ul>	<ul style="list-style-type: none"> <li>用刷子刷洗</li> <li>刷不掉時，應更換過濾網(參看第31頁)。</li> </ul>
指示燈交替閃爍。	<ul style="list-style-type: none"> <li>防止空燒功能啟動。(參看第23頁)</li> <li>加入熱水或視乎加水方法的不同，指示燈或會交替閃爍。</li> <li>當用檸檬酸清洗內瓶時，檸檬酸沉積在瓶底。</li> </ul>	<ul style="list-style-type: none"> <li>加水，然後按 <b>Reboil</b> 鍵。</li> <li>按下 <b>Reboil</b> 鍵。</li> <li>先拔下插頭，充分攪拌，使檸檬酸分散，然後再清洗。</li> </ul>
不出水。	<ul style="list-style-type: none"> <li>自動鎖定功能已啟動。</li> </ul>	<ul style="list-style-type: none"> <li>按下 <b>Lock/Unlock/Slow On/Off</b> 鍵。</li> </ul>
<ul style="list-style-type: none"> <li>如果進行上述檢查後，問題仍未得到解決，或者您認為有些事情很蹊蹺，請從本體上拔掉機身插頭。至少等待10秒鐘後，再重新插上插頭。</li> <li>上蓋內側的半透明部分有時發黃，但並不影響使用。</li> <li>開閉上蓋時發出的聲響，是防逆流閥工作的聲音，其作用是萬一翻倒時防止熱水流出。</li> <li>如果房間溫度非常高，本體外殼的溫度可能會達到約55°C。</li> </ul>		
本體不能通電	<ul style="list-style-type: none"> <li>從出水口直接壓水。</li> <li>本體放在水槽中。</li> <li>本體倒置、底部潮濕。</li> <li>拿用水清洗了本體。</li> </ul>	<ul style="list-style-type: none"> <li>如果電氣部件已沾上水可能產生故障。請與購買經銷商聯系修理。</li> </ul>
「再沸騰」和「80°C」指示燈交替閃爍。	<ul style="list-style-type: none"> <li>這是傳感器功能失常。</li> <li>請聯絡您購買產品的商店。</li> </ul>	

# 更換易耗品

## 密封墊圈套件

當墊圈破裂、失去彈性或可造成蒸汽從內膽與蓋子間溢出時，更換墊圈。

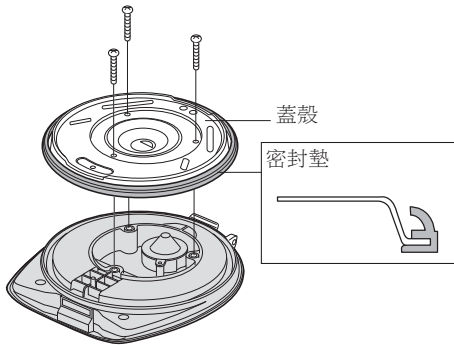

卸下三支螺釘，取下蓋殼，更換密封墊。

## 過濾網

用刷子刷不掉水垢時，應更換過濾網。

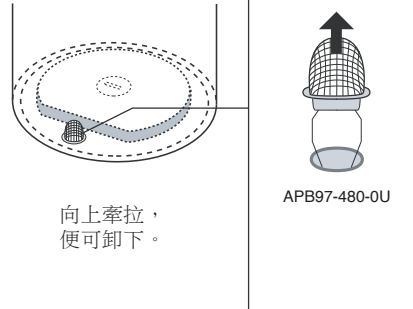

向上牽拉，  
便可卸下。

如需替換零件，  
請請聯絡授權代理商。

易耗品名稱	易耗品編號
密封墊圈套件	APH65-480
過濾網	APB97-480-0U

# 規格

型號		NC-EG4000	NC-EG3000	NC-EG2200
電源		220V ~ 50Hz		
耗電量		700W		
平均保溫時的耗電量（約） （水量：最大、室溫：20°C）	98保溫	49瓦/時	45瓦/時	40瓦/時
	90保溫	43瓦/時	39瓦/時	33瓦/時
	80保溫	35瓦/時	31瓦/時	27瓦/時
	70保溫	30瓦/時	26瓦/時	23瓦/時
尺寸 （高X寬X側寬） 放倒提手的狀 態下	高（約）	32.4厘米	27.5厘米	23.8厘米
	寬（約）	21.7厘米	21.7厘米	21.7厘米
	深（約）	28.7厘米	28.7厘米	28.7厘米
重量（包括電源線）（約）		2.2公斤	2.1公斤	2.0公斤
額定容量（約）		4.0公升	3.0公升	2.2公升

\* 在特殊地區(高地、嚴寒地區等)使用時，有時不能確保規定的性能。儘量不要在特殊地區使用。

\* 冬季不使用時，應排出剩水。否則，內瓶內的水結冰，會損傷零件。

**Panasonic Corporation**  
Website : <http://www.panasonic.com>  
© Panasonic Corporation 2015

PZ05H6933  
TP0815E31021  
Printed in Thailand