

6.1.2 CS-PN18ZKA CS-PN24ZKA

<Top View>

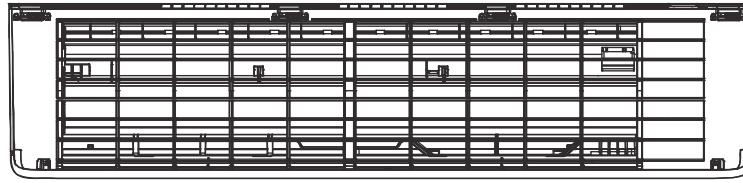

<Side View>

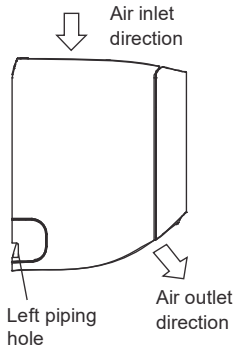

<Front View>

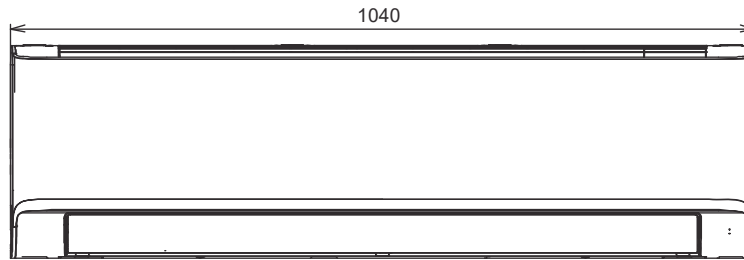

<Side View>

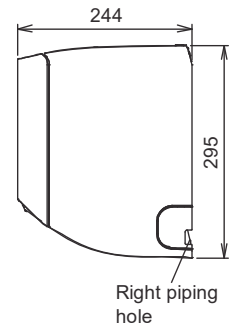

<Bottom View>

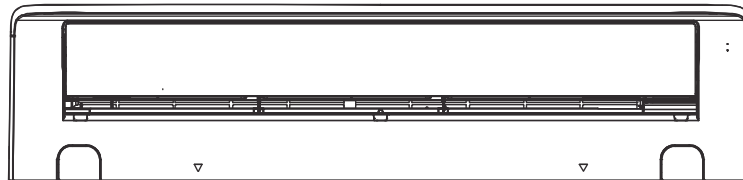

<Remote Control>

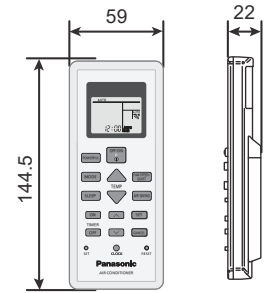

<Rear View>

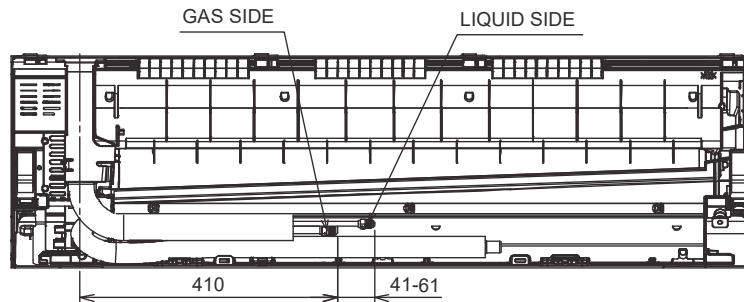

<Remote Control Holder>

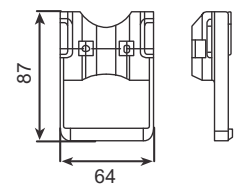

Relative position between the indoor unit and the installation plate <Front View>

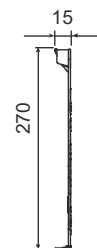
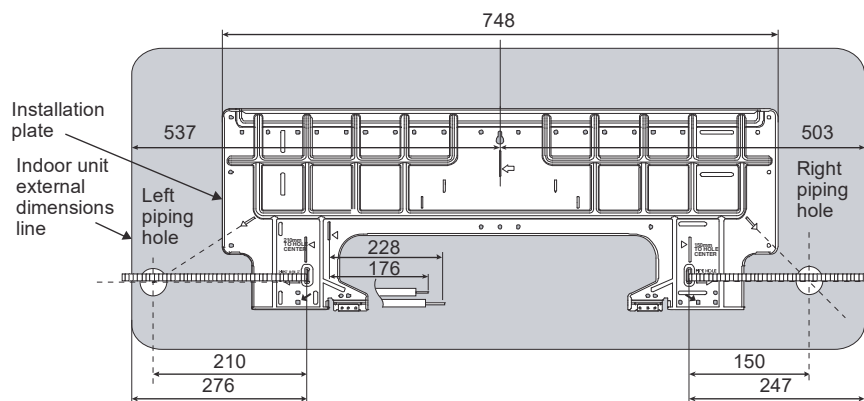

Unit: mm

6.2.3 CU-PN18ZKA CU-PN24ZKA

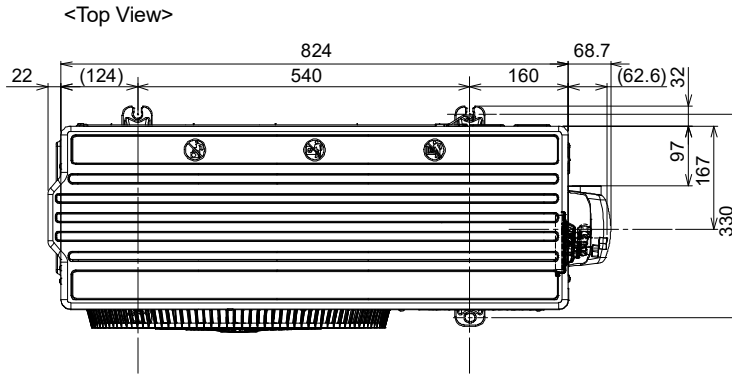
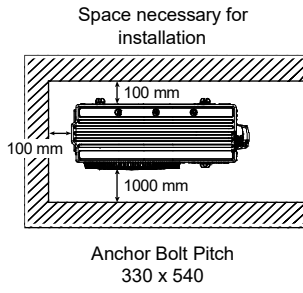

<Side View>

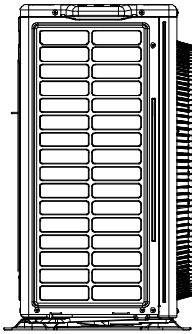

<Front View>

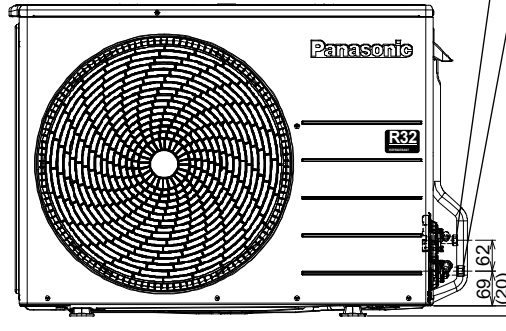

2-way valve at Liquid side
(High Pressure)
3-way valve at Gas side
(Low Pressure)

<Side View>

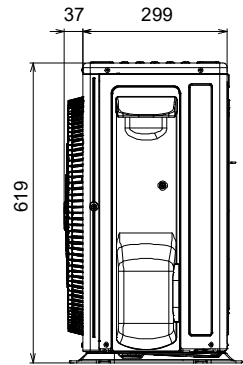

Unit: mm